

CIRCULATION OF THIS ISSUE OVER 235,000 COPIES

RADIO NEWS

REG. U.S. PAT. OFF.

25 Cents
August

1922

Over 125 Illustrations

Edited by H. GERNSBACK

"RADIO INVADES HICKSVILLE"

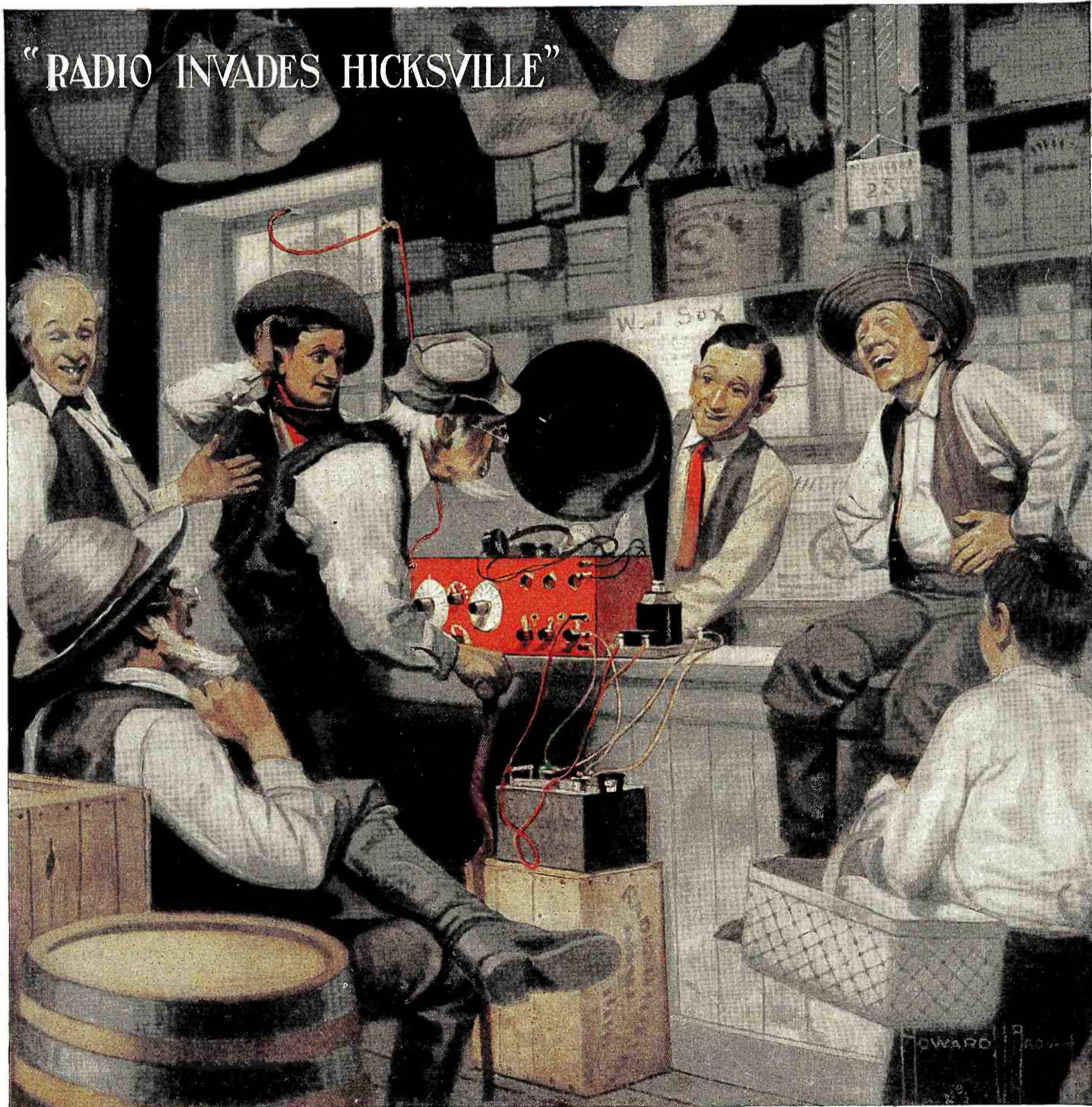

CIRCULATION LARGER THAN ANY OTHER RADIO MAGAZINE

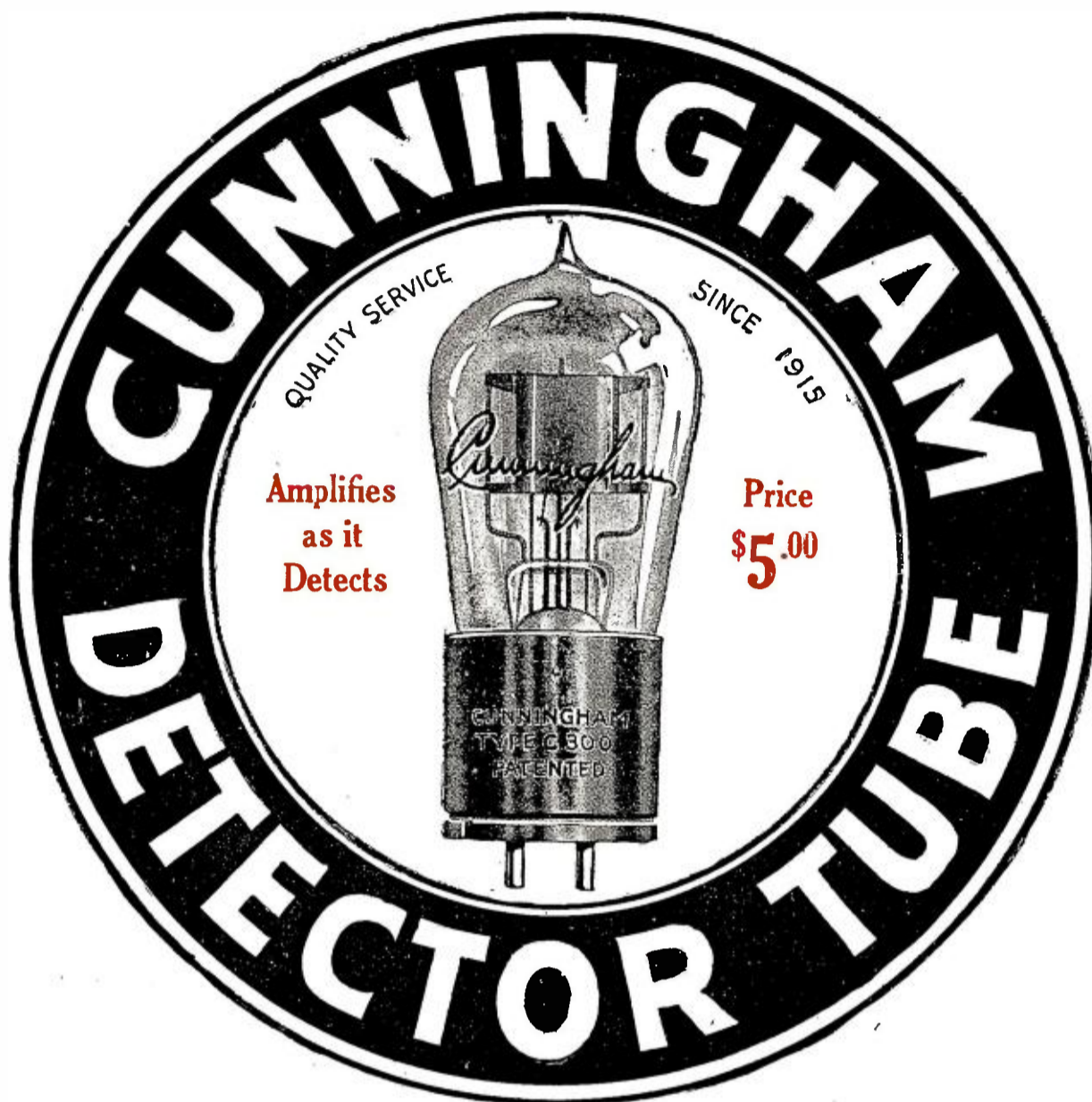

PATENT NOTICE
 Cunningham tubes are covered by patents dated 11-7-05, 1-15-07, 2-18-08 and others issued and pending. Licensed only for amateur or experimental uses in radio communication. Any other use will be an infringement.



The trade mark GE is the guarantee of these quality tubes. Each tube is built to most rigid specifications.

CUNNINGHAM TYPE C-300 GAS CONTENT DETECTOR

*—it gives clearest reception
 for all makes of Home Receiving Sets*

CUNNINGHAM Detector Tubes are built in the great General Electric Laboratories to the most rigid specifications. Years of research work and study, combined with the most scientifically accurate mechanical equipment in the world has made it possible to manufacture these quality tubes that give such remarkably effective results.

The pleasure that your Home Receiving Set will give you depends largely on the CLEARNESS OF RECEPTION of messages, concerts, etc.—therefore, be sure to get CUNNINGHAM TUBES for YOUR set.

For further particulars see or write your nearest dealer; or write us direct.

248 First Street
 San Francisco, Calif.

Trading as
 AUDIOTRON MFG. COMPANY

154 West Lake Street
 Chicago, Illinois

ANNOUNCING *The New* OLIVER

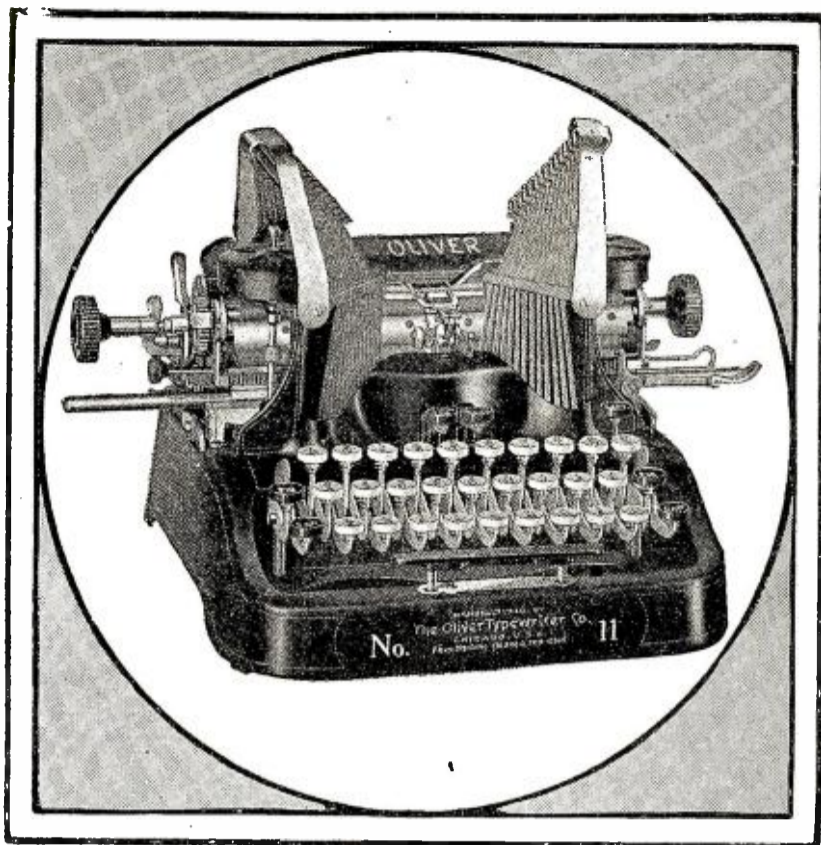

SPEEDSTER

Our latest and finest model, No. 11

Save \$35

Free Trial

Now, in our 27th year, we introduce a new-day perfection in typewriters, a super-typewriter, one with an ancestry of 1,000,000 Olivers. It embodies many advancements, countless refinements. It is the climax of years of development.

We want everyone who is planning to buy a typewriter to become acquainted with this remarkable Oliver Speedster. Note our offer below. To see it, to operate it, brings a new appreciation of the ultimate.

The Oliver Speedster discards many old ideas, many limitations. It brings dozens of improvements which you will appreciate quickly. To own an Oliver Speedster—years ahead in design—means a new satisfaction.

No one now can afford to buy any typewriter without first investigating this advanced and wonderful Oliver, the finest, the most durable, the quietest model we've ever built.

While we retain all the fundamental and proven features which have brought such fame to earlier models, and while we bring improvements not to be found elsewhere, we do not revert to the customary \$100 price.

The new Oliver Speedster, worth \$100 if any typewriter is, is sold from factory-to-you, at \$65, saving you the \$35 that it formerly cost to sell an Oliver.

Our policy, since 1917, has been to produce the finest typewriter possible at the lowest cost. We have eliminated extravagant, roundabout selling plans, and substituted the popular factory-to-you plan. The Oliver sells itself. It must prove that it is the finest, regardless of price.

We ship the new Oliver Speedster to you for five days free trial. That is the best way for you to become acquainted with its advancements. Use it as if it were your own. Note its superiorities. Compare it. See what the numerous improvements offer.

Then if you agree that it outclasses any typewriter on the market, and want to buy it, send us only \$4 after trial, then \$4 per month. If you do not want to keep it, ship it back at our expense.

This free trial does not obligate you to buy. It is part of our new plan. You are the sole judge. The coupon brings the Oliver, or further information. Check which you desire.

The Oliver Typewriter Company

63B Oliver Typewriter Building
Chicago, Ill.



THE OLIVER TYPEWRITER COMPANY

63B Oliver Typewriter Building, Chicago, Ill.

Ship me a new Oliver No. 11 Typewriter for five days' free inspection. If I keep it I will pay \$65 as follows: \$4 at the end of trial period and then at the rate of \$4 per month. The title to remain in you until fully paid for. If I make cash settlement at end of trial period I am to deduct ten per cent and remit to you \$58.50. If I decide not to keep it, I will ship it back at your expense at the end of five days.

My shipping point is _____
 Do not send a machine until I order it. Mail me your book—"The High Cost of Typewriters—The Reason and the Remedy," the Speedster catalog and further information.

Name

Street Address

City..... State.....

Occupation or Business

RADIO NEWS

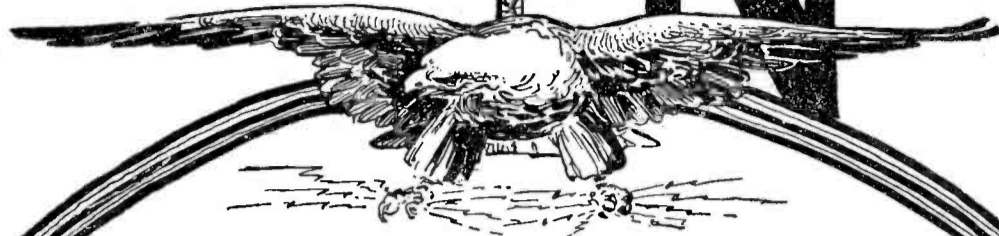

CONTENTS

VOL. 4

FOR AUGUST

No. 2

	PAGE		PAGE
Editorial.....By H. Gernsback	221	The Bogeyman of Radio.....	244
Radio Instructions at Camp Alfred Vail, N. J. By S. R. Winters	222	Multiple Wave-Lengths to Improve Broadcasting By H. Winfield Secor	245
Station PCG at Sambeek, Holland. By J. Thissen	223	The World's Largest Radio Horn.....	245
Tropical Stations of Unusual Interest By Charles Adolph Reberger	224	The Newspaper's Part in Radio Development By Roscoe Smith	246
Seven New Radio Stations Have Combined Power for Transmitting 46,750 Miles.....	225	Radiophone Broadcasting Station Installed by Texas Newspaper.....	246
Radio Telephotography....Dr. Alfred Gradenwitz	226	A Hill Billy's Radio....By Monroe Worthington	249
New Radio Apparatus.....	228	With the Amateurs.....	250
German Radio Press Receiver By Maurice E. Pelgrims	229	Radio Humor.....	253
Transmission of Photographs by Radio By Arthur Benington	230	Potash and Perlmutter Discuss This Here Radium Broadcasting.....By Montague Glass	254
Marconi Presented with Radio Institute Medal of Honor.....	231	Self-rectification.....By D. S. Basim	255
Advertising by Radio. Can It and Should It Be Done?.....By J. C. McQuiston	232	Four Principles for Care of Radio Storage Batteries By R. C. Faulwetter	255
Radio to Supplant Universities. By Lucian Jenness	232	Radio Constructor.....	256
Who's Who in Radio--Louis Cohen.....	233	A Simple and Practical Variable Condenser By J. A. Frank	257
A. C. Rectification for C. W. By E. T. Jones, A.I.R.E.	234	Radio Cabinets.....By L. M. Klinefelter	257
Correspondence from Readers.....	235	How to Build a Loud-Speaker.By Paul G. Watson	258
A 200-Watt A. C. Radiophone Transmitter By I. R. Lounsberry	236	The Construction of An Ideal Short Wave Re- ceiver.....By Edmond S. Smith	258
Radio Digest.....	237	Winding and Using Honeycomb Coils By Harry L. Gray	259
Sensitivity and Precision of the Electrostatic Transmitter for Measuring Sound Intensities By E. C. Wente	238	A Low Voltage Filter for Radiophones By Eugene W. Applebaum	259
The Armstrong Super-Regenerative Circuit.....	239	A Watch Case Receiver.....By Brainard Footc	260
The Electron Theory Simplified By Edward T. Bicak	240	Single Layer Inductances...By Herbert J. Scott	261
Summer Brings the Portable Sets.....	241	Practical Information on Reception of Radio Signals.....By B. Bradbury	262
President's Voice Carried to Thousands.....	242	Useful Hints for Amateur Constructors.....	264
Motor Bus Equipped with Radio.By Charles Geiger	242	Combination Radio Cabinet and Table By Philippe A. Judd	266
New York Radio Exhibition.....	243	Soldered Connections.....By F. Martindell	266
		I-Want-to-Know.....	267

RADIO NEWS is published on the 25th of each month. There are 12 numbers per year. Subscription price is \$2.50 a year in U. S. and possessions. Canada and foreign countries, \$3.00 a year. U. S. coin as well as U. S. Stamps accepted (no foreign coins or stamps). Single copies, 25 cents each. A sample copy will be sent gratis on request. Checks and money orders should be drawn to order of EXPERIMENTER PUBLISHING CO., INC. If you should change your address notify us promptly, in order that copies be not miscarried or lost. No copies sent after expiration.

All communications and contributions to this journal should be addressed to Editor, RADIO NEWS, 53 Park Place, New York. Unaccepted contributions cannot be returned unless full postage has been included.

Published by EXPERIMENTER PUBLISHING CO., INC.,
Publication Office: Jamaica, N. Y. Editorial and General Offices: 53 Park Place, New York City
H. GERNSBACK, President S. GERNSBACK, Treasurer R. W. DEMOTT, Secretary

All accepted contributions are paid for on publication. A special rate is paid for novel experiments; good photographs accompanying them are highly desirable.

RADIO NEWS, Monthly. Application has been made for transfer of the second-class mailing privilege from New York, N. Y., to Jamaica, N. Y. Title registered U. S. Patent Office. Copyright, 1921, by E. P. Co., Inc., New York. The Experimenter Publishing Co., 53 Park Place, N. Y. The Contents of this magazine are copyrighted and must not be reproduced without giving full credit to the publication.

RADIO NEWS is for sale at all newsstands in the United States and Canada; also at The International News Co., Ltd., Bream's Building, London E. C. 4, England, and at Brentano's, 37 Avenue de l'Opera, Paris.

Publishers of "Radio News" and "Science and Invention."

CREBE RADIO



"He who has heard but part of the truth"
said Chuang Tzu,
"thinks no one equal to himself."

Compare your present outfit with a Crebe!

Doctor My.

Licensed under
Armstrong U. S. Patent,
No. 1113149.



A Quality Achievement

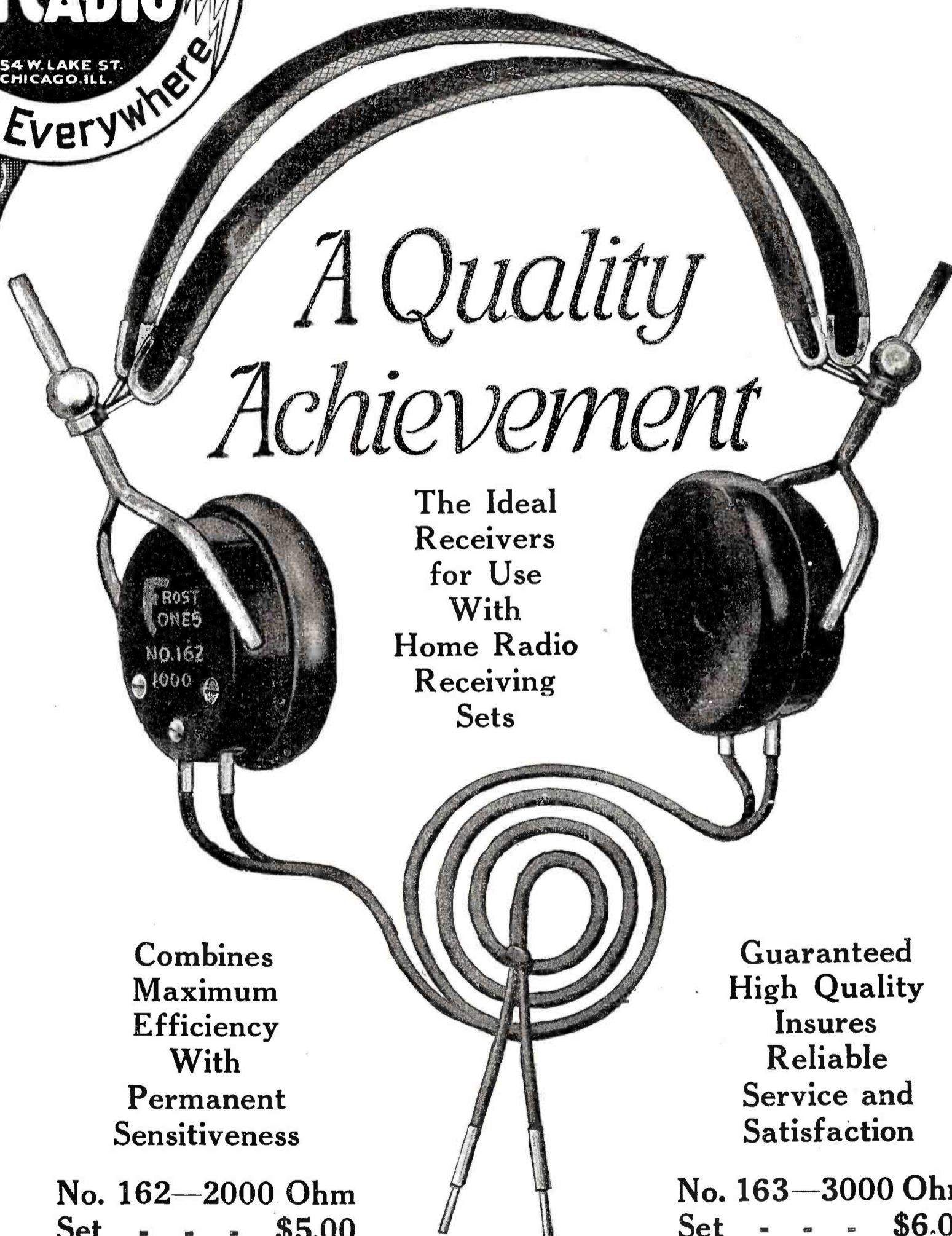

The Ideal
Receivers
for Use
With
Home Radio
Receiving
Sets

Combines
Maximum
Efficiency
With
Permanent
Sensitiveness

Guaranteed
High Quality
Insures
Reliable
Service and
Satisfaction

No. 162—2000 Ohm
Set - - - \$5.00

No. 163—3000 Ohm
Set - - - \$6.00

HERBERT

154 W. LAKE STREET

Frost-Radio Cord-
Tip Plug No. 137—
\$1.25

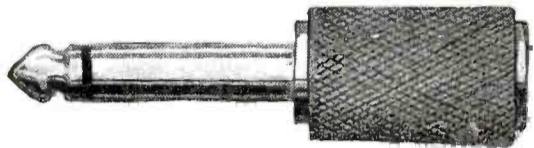
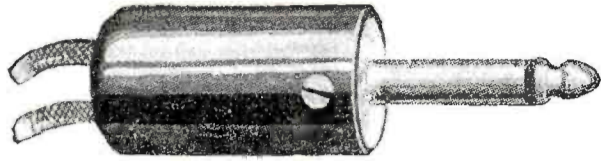

Frost-Radio Plug No.
132—\$1.00



FROST-RADIO PLUGS and JACKS

The smallest, neatest, most perfectly finished jacks and plugs that have ever been offered to the Radio trade. They have been specially designed for panel work and are of standardized construction so as to be interchangeable with other standard makes.

A particularly desirable and exclusive feature of the FROST-RADIO Jack is the "spread" arrangement of the spring terminals which allows twice the usual amount of space for soldering to the wiring. These terminals are heavily tinned.

Another striking feature is the nickel plated and highly buffed finish used throughout.

Sturdy construction, perfect spring adjustment, gripping contact of springs on tip and sleeve of plug.

Packed in individual containers.

Two-color wall posters now ready for Dealer distribution.

WE ARE NOW IN QUANTITY PRODUCTION AND ARE MAKING IMMEDIATE DELIVERIES.

Something New!

Place your Loud Speaker anywhere and use the Frost-Radio Extension Cord (shown here) to connect with your Radio Set.

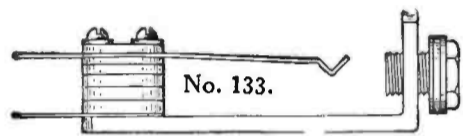

No. 133. Jack only - \$0.65



No. 134. Jack only - \$0.75

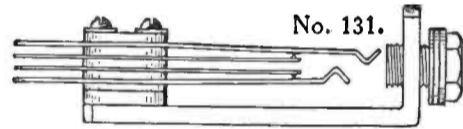

No. 131. Jack only - \$0.90

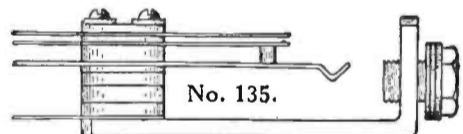

No. 135. Jack only - \$1.00

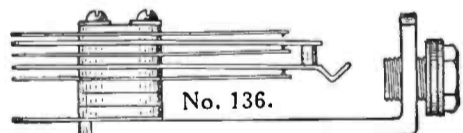

No. 136. Jack only - \$1.25

FROST-RADIO EXTENSION CORD

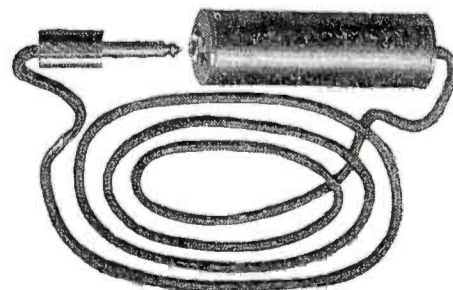

Lengths from 10 to 100 feet

H. FROST

CHICAGO, ILL., U. S. A.



Frost-Radio Protector

Approved by Underwriters' Laboratories Under April, 1922, Regulations

**NEVER GROUNDS - - NO INTERFERENCE
SELF-CLEANING**

No
Interference
With
Radio

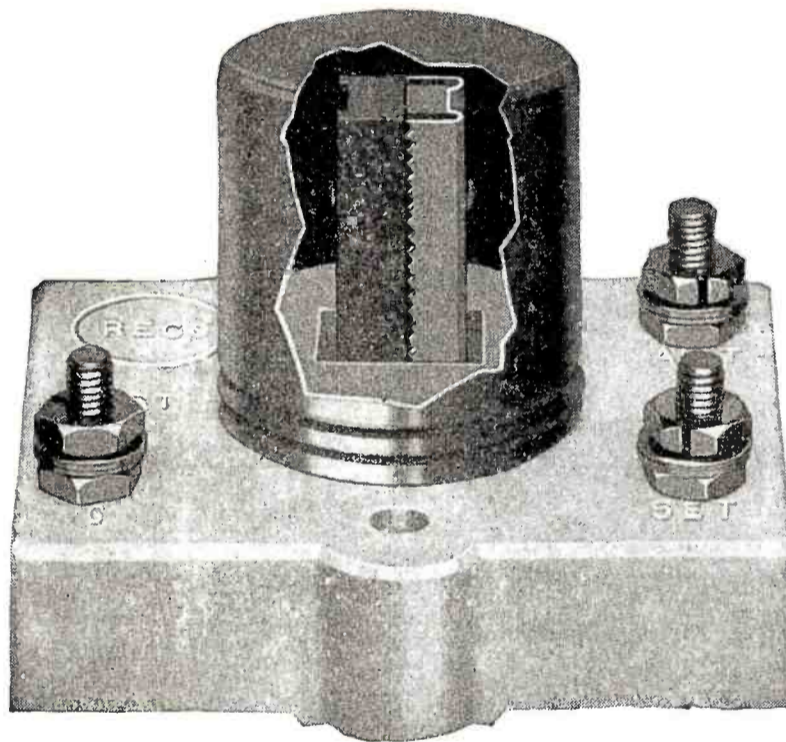

Mounts
Indoors
Like Your
Telephone
Protector

PRICE, EACH, \$1.50

Every Home Receiving Set Must Be Protected Under
New Regulations of April, 1922

Made by the Manufacturers of the "Reliable" Telephone
Arrestors. Famous for 12 Years

JOBBERs: Good Delivery on This *Approved*
Device. Write at Once

HERBERT H. FROST

154 W. Lake Street - - CHICAGO, ILL.

CROSLEY

Crosley Knobs and Disks

Finely finished products, tapered knobs and clear dial markings. Exceptionally fine Radio fittings.

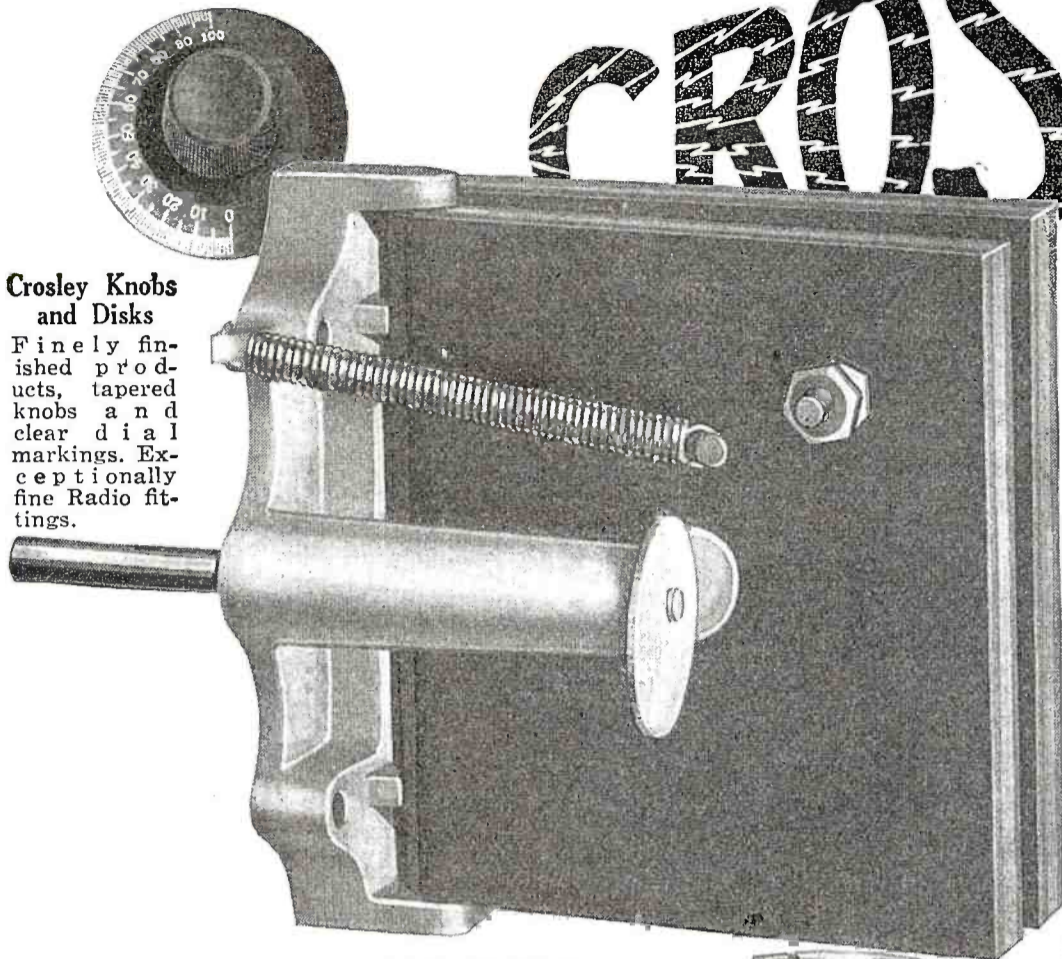

Efficient Radio Apparatus

PARTS AND COMPLETE RECEIVING UNITS

at Moderate Prices

Quantity production in the great Crosley factories makes possible the low prices at which Crosley Radio goods can be sold. Their efficiency is assured. Satisfied users the country over have filled our files with congratulatory letters. All apparatus is fully guaranteed.

Crosley Model "B" CONDENSER

A Crosley Model B Variable Condenser (.0005 mf capacity). Pat. pending. A radically better condenser, less internal resistance, gets louder signals. Same as used in Crosley Harko Receivers, \$1.75.

CROSLEY TAP SWITCHES

Crosley Tap Switches designed for constant tension and elimination of faulty contacts. Buss wire connection possible to washer of special Crosley design. Black composition knob, and nicked parts. Each, 40c.

CROSLEY VARIOCOUPLER PARTS

A formica tube, rotor and necessary hardware for complete assembling. Made with great accuracy and has proven very efficient. Complete Set, \$1.50

CROSLEY V. T. SOCKET

Crosley porcelain vacuum tube socket (base or panel mountings), biggest seller on the market. Same design as used in all Crosley apparatus. Price, 60c.

Crosley Radio Receiving Apparatus

Highly efficient tuning and detecting sets which with Crosley 2-stop Amplifier is proving a remarkable audion receiving set at a very moderate price.

CROSLEY HARKO SENIOR V

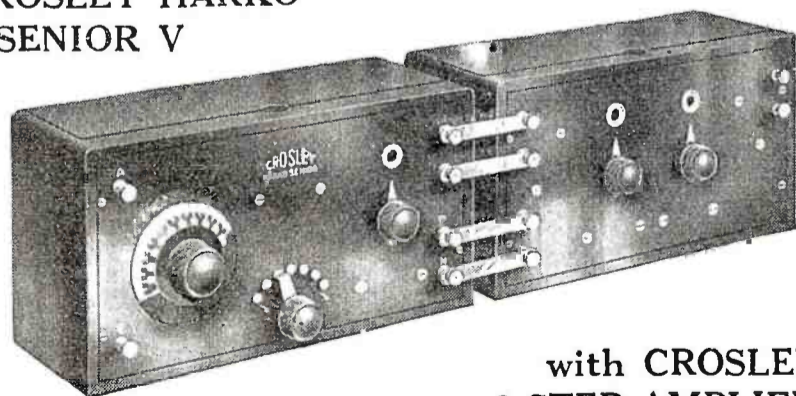

with CROSLEY 2-STEP AMPLIFIER

CROSLEY RHEOSTAT

Crosley Rheostat for vacuum and filament current control. Duplicate of those used in Crosley Harko Receivers and 2-step amplifiers. Sturdy, durable; price, 60c.

Complete Catalog on Request

CROSLEY VARIOMETER

Unassembled parts for radio fans who prefer to work out their own ideas in construction of this unit. Two stators, one rotor and necessary hardware. Made in our own wood-working plant in sufficient quantities to make retail price \$1.50 for Poplar wood set and \$1.75 for those in Mahogany.

If you contemplate entering the Radio business write us fully about yourself, your experience, if any, and we will advise you what stock you should carry for a complete Radio store.

WRITE FOR CATALOG
DEALERS WANTED

THE CROSLEY MANUFACTURING CO.

DEPARTMENT RN822, CINCINNATI, O.

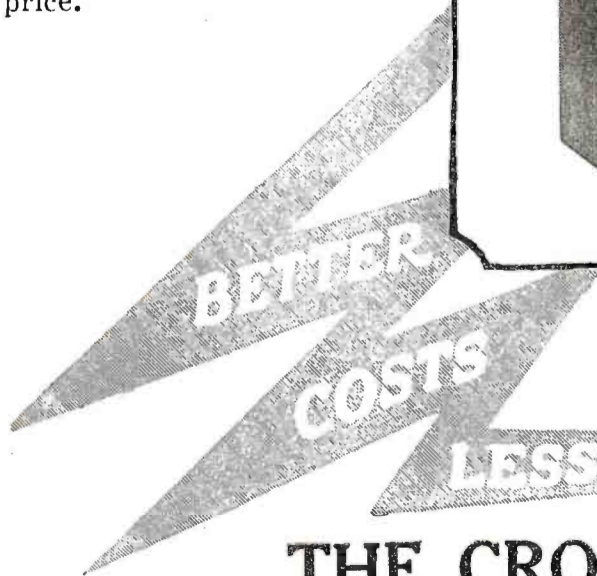

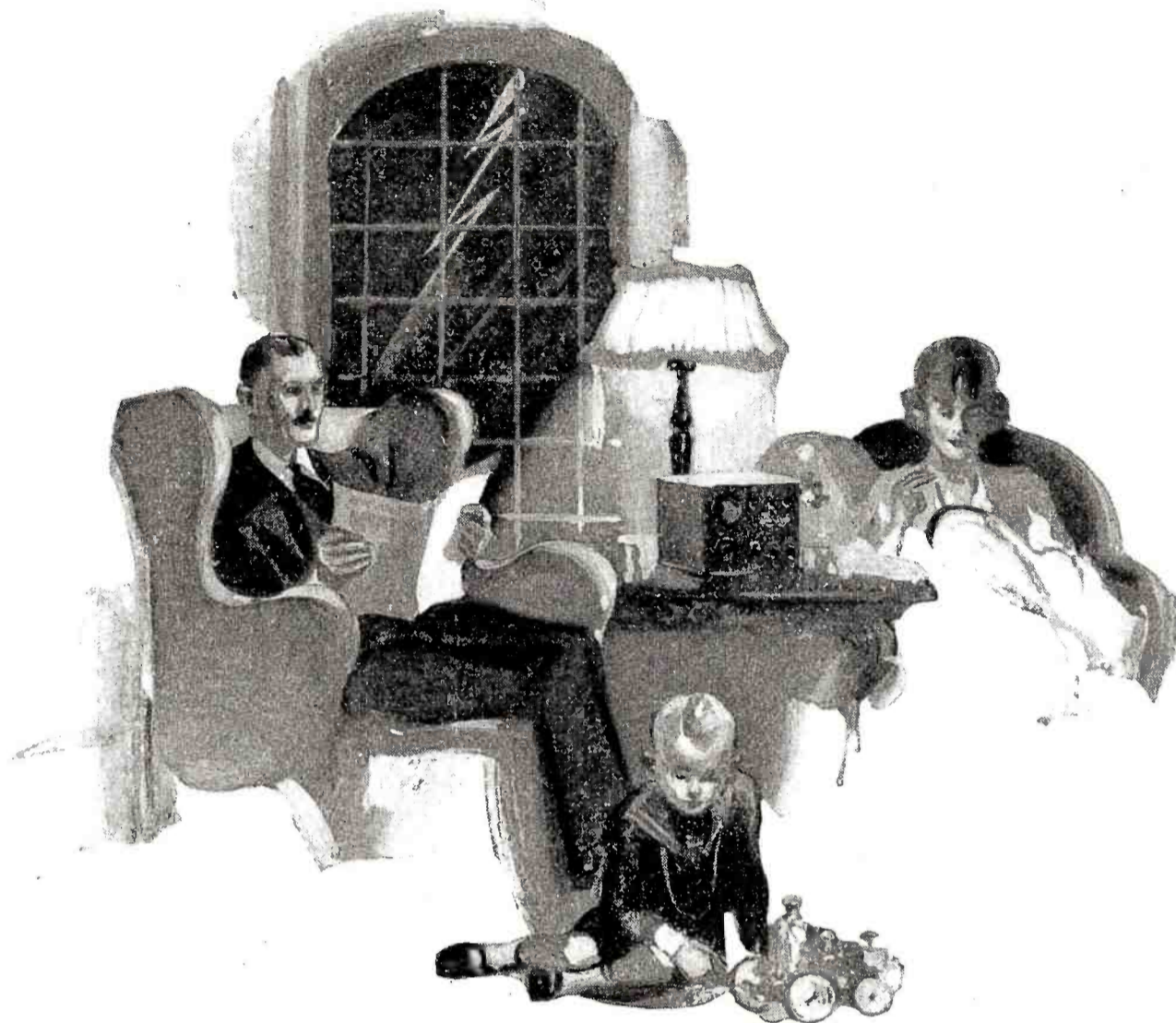

Clamping the jinx on lightning pranks

NIGHT and a storm—the sky's aflame. Now's the time you're glad you had the forethought to buy a Radisco Lightning Arrester for your radio set. Without it the high induced charges always present in your antenna during an electrical storm can ruin the delicate instruments.

With the Radisco Lightning Arrester installed on your antenna wire you clamp the jinx on lightning's pranks. The Radisco continually side-tracks these high

induced charges (caused by lightning in your neighborhood) before they can harm your set.

Neat, inexpensive. Outside type \$3, or the inside type for \$2.50, at your dealer's or mailed direct. Ask also for our special summer catalog of radio supplies. You will find the best in many types of radio products listed for your convenience. Get it now while the supply lasts. The Radio Distributing Co., Newark, N. J.

RADISCO LIGHTNING ARRESTER

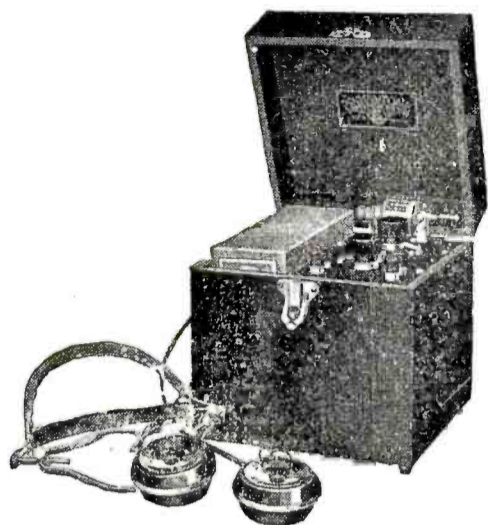

The Pink-a-tone

Guaranteed range, 30 miles

JUST the thing for camping—portable and dependable. A highly efficient and selective set encased in a handsome mahogany finished cabinet. Famous No. 2A Stromberg-Carlson 2000 Ohm phones included. All that is needed is an aerial. Price, \$25.00.

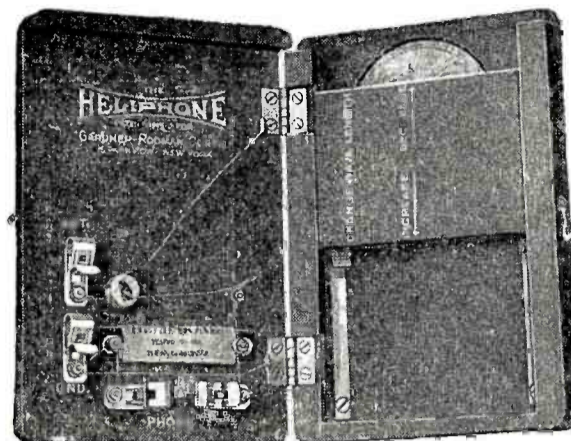

Pocket Receiver

Only \$5.00

HERE is the most convenient small set you can buy. Fits the coat pocket. Excellent for camping or hiking. Approximate range, 30 miles—permits sharp tuning. With the exception of phones and aerial this set is complete in every detail. A remarkable value.

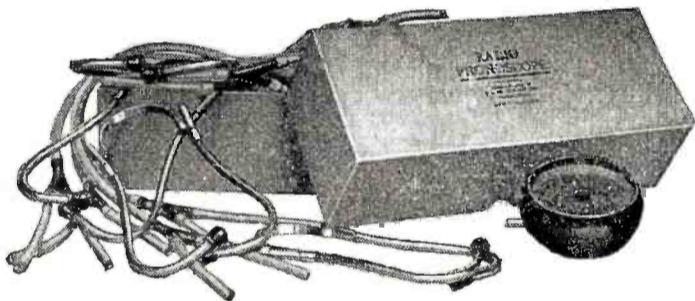

Four can listen with a Phonoscope

Only \$5.00

EXTRA headphones are unnecessary. The Phonoscope permits four people to "listen in" for \$5.00. (Four sets of phones cost from \$20 to \$60.) The phonoscope does not cause distortion in tone quality; voice and music alike are reproduced clearly. Exactly what you need for entertaining your friends.

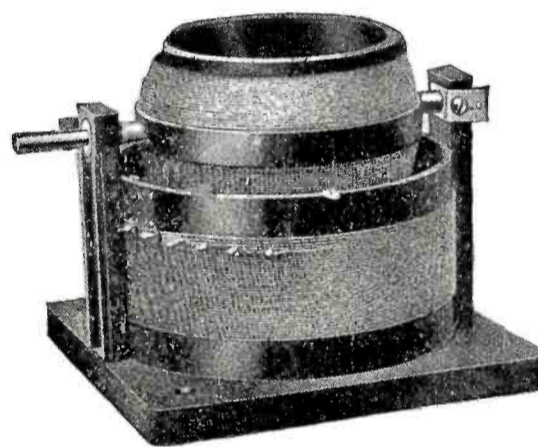

Radisco Variocoupler

\$6.00

THIS moulded variocoupler has been the standard of the Radio Distributing Company for years. The moulded supporting columns have brass bearings. Positive contact is assured by phosphor bronze brushes at each bearing. Wire is insulated with special black varnish to protect from moisture. Wave length range with suitable condensers, 150 to 700 meters.

RADISCO RADIO PRODUCTS

FADA TUBE SOCKETS

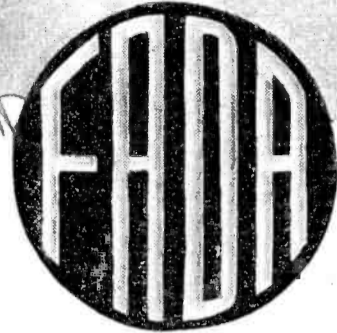

Trade Mark Registered

THE proper selection of radio parts is the first secret of success. To eliminate the "chance", purchase FADA rheostats, inductance switches, series-parallel switches, crystal detectors, binding posts, and tube sockets. FADA single, double and triple tube sockets have these good features:

1. Genuine Condensite base affording the highest insulation resistance.
2. Deep trenches make contact springs immovable except as a tension against the tube contact pins.
3. Heavy phosphor bronze springs.
4. Socket base has metal inserts for panel mounting and nickel plated screws are furnished.
5. Position of tube on base is offset to allow compact rheostat panel mounting, as shown in illustration below.
6. Screw holes for base mounting.
7. Terminals plainly marked.
8. Highly nickel plated and polished brass tube with bayonet slot eliminating slot breakage as with moulded shellac or porcelain sockets.

	Single Socket.....	\$1.00
	Double Socket.....	2.00
	Triple Socket.....	3.00

The illustration below shows an easy, compact and efficient method of panel mounting FADA rheostats and sockets. All exclusive FADA features are protected by Pats. applied for.

F. A. D. ANDREA

Manufacturer of Radio Products

1581-B Jerome Avenue
NEW YORK CITY

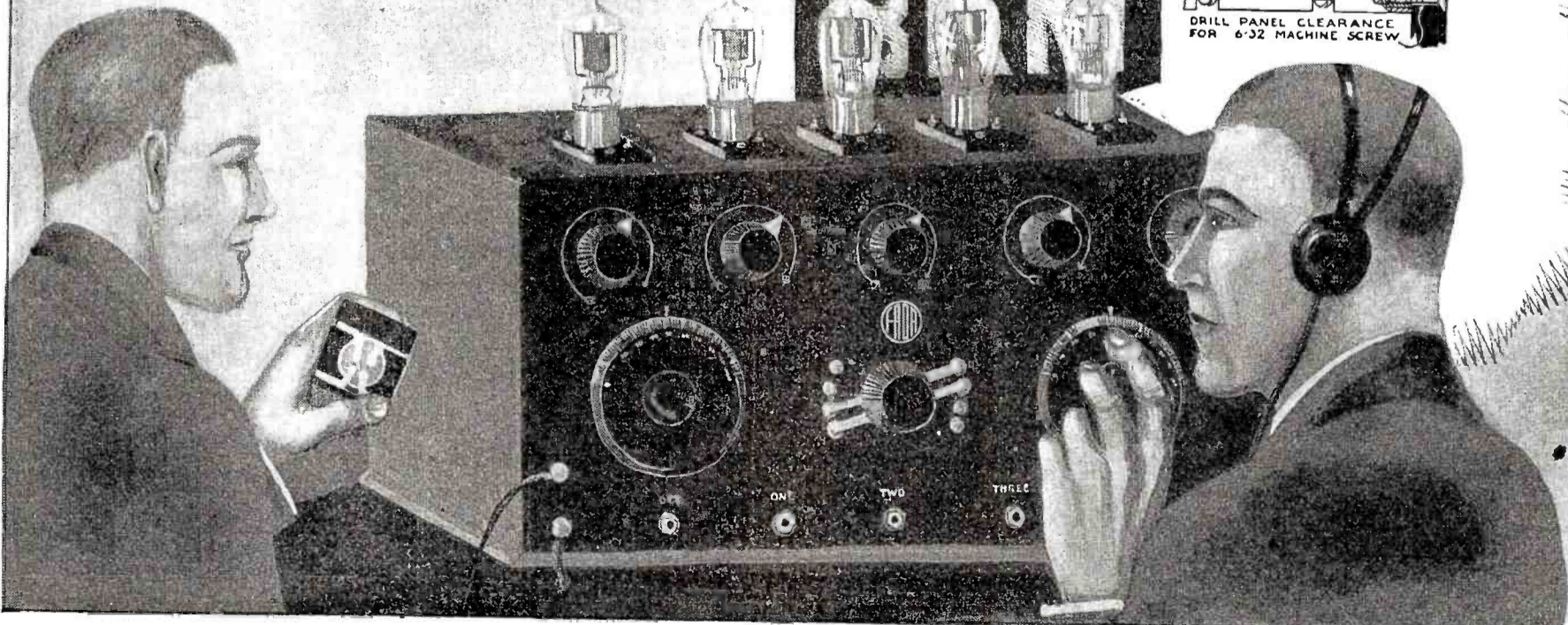
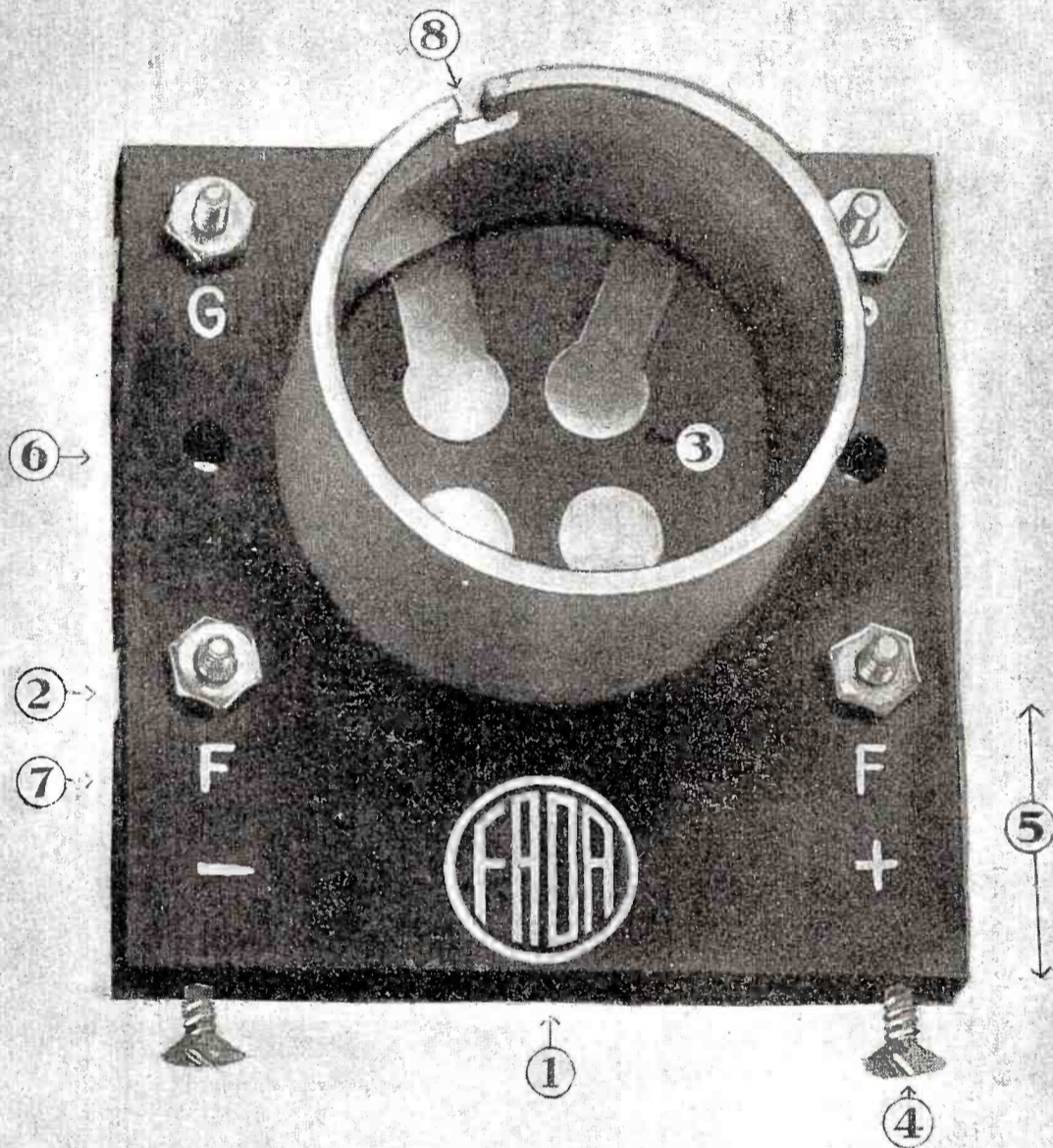
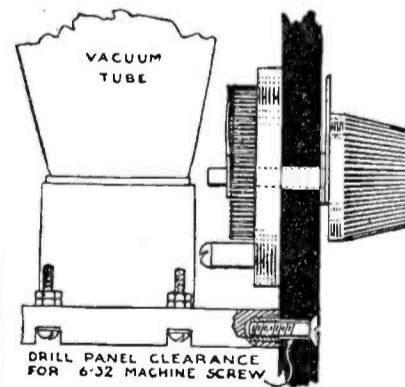

Free Railroad Fare

L
E
A
R
N

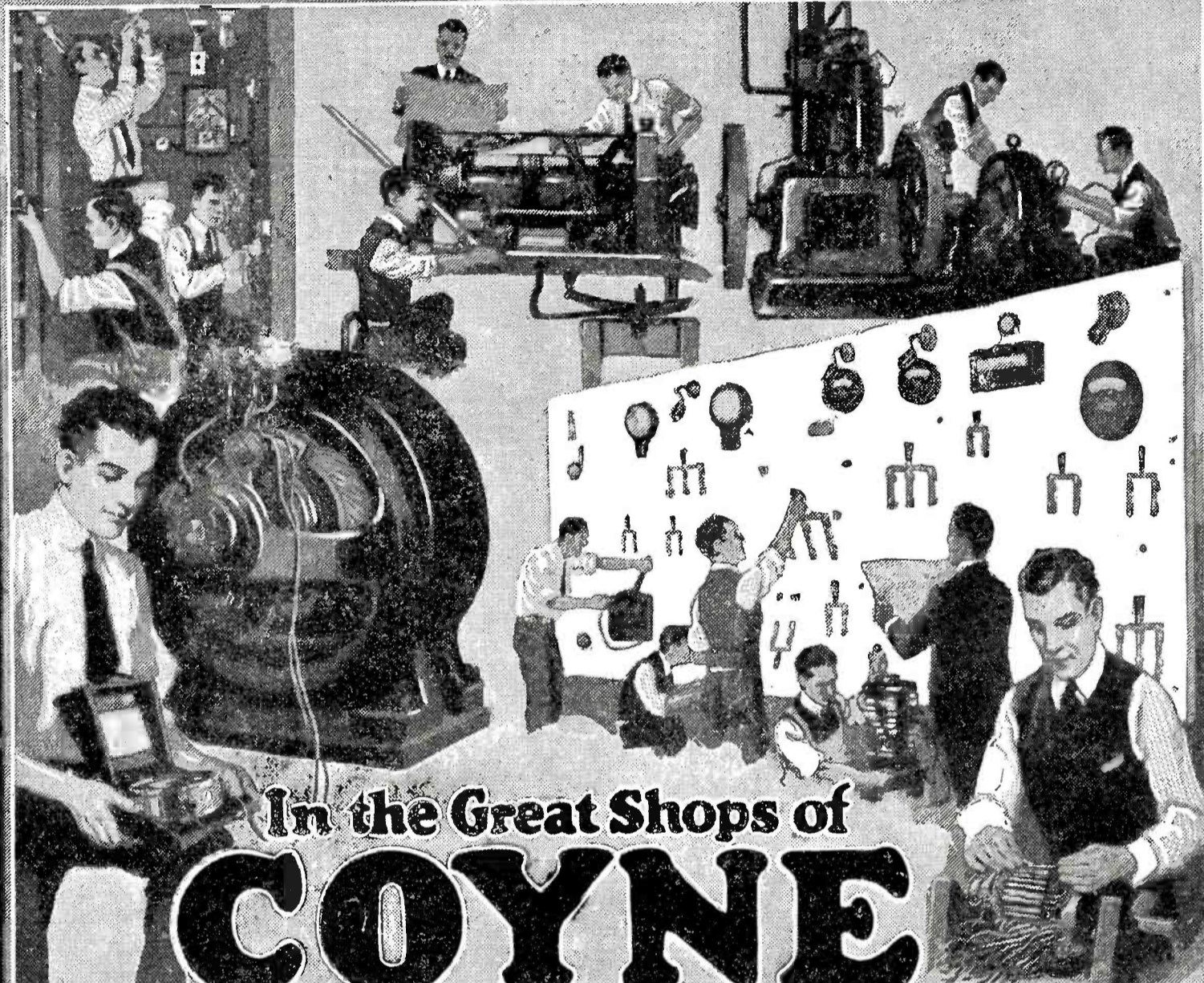

In the Great Shops of
COYNE

E
L
E
C
T
R
I
C
I
T
Y

Make this the most profitable and enjoyable summer of your life. Come to Chicago, the greatest summer resort city in the country on beautiful Lake Michigan, and the greatest electrical center in the world. We will pay your railroad fare from any place in the United States, See the country at our expense. And at the same time become a skilled electrical expert in the Great Shops of Coyne.

EARN WHILE YOU LEARN

Our Employment Department helps place students in jobs to earn a good part of their expenses while studying.

Learn in 3½ Months

No books or useless theory. You are trained on \$100,000 worth of electrical equipment. Everything from door bells to power plants. You work on motors, generators, house-wiring, autos, batteries, radio, switch-boards, power plants—everything to make you an expert ready to step right into a position paying from \$45 to \$100 a week. Learn electricity in the electrical center of the world. Here you see the mighty power plants, the great electrical manufacturers and marvelous electrical sign displays. You truly live with electricity in Chicago.

Earn \$150 to \$400 a Month!

The whole world of electricity is open to the Coyne trained man. He is trained completely. He can make big money as Power Plant Operator, Superintendent,

Telephone man, Construction Worker, Auto, Truck or Tractor Electrician, Battery Man, Radio Expert, or he can go into business for himself as Electrical Contractor, Dealer, Auto Ignition or Battery Expert and make from \$3,000 to \$20,000 a year. Hundreds of our graduates today are making big money and you can do the same if you grasp this opportunity—act now. Send for full particulars today.

Radio Course FREE!

Besides paying your railroad fare we include with your regular course:

- (1) A complete course in auto, truck and tractor electricity and storage batteries. Greatest outlay of auto electrical and battery equipment in the country.
- (2) Course in Radio—the marvel of the age. Constructing, installing and operating. You can build your own wireless telephone set.
- (3) A life scholarship in the Coyne School. You can stay as long as you wish and return for further training at any time in the future. The aim of the Coyne School is to turn out men completely trained in all branches of electricity—capable of succeeding in the highest paid positions.

Greatest Offer Ever Made

This is the greatest offer ever made by a school and it is for a limited time. Our departments may soon be filled and offer withdrawn.

SEND This → Coupon NOW

Don't delay a minute — send that coupon in right now for our big free catalog and full particulars of this wonderful offer.

B. W. COOKE, President
Coyne Trade and Engineering School
39-51 East Illinois Street,
Dept. 118 Chicago, Ill.

B. W. COOKE, President
Coyne Trade and Engineering School
39-51 E. Illinois Street,
Dept. 118 Chicago, Ill.
Dear Sir: Please send me free your big catalog and full particulars of your special offer of free railroad fare and three extra courses.

Name

Address

Great Summer Resort City

Chicago, situated on beautiful Lake Michigan, is the Nation's summer playground. Marvelous boulevards, beautiful parks, bathing beaches, zoos, lake trips, amusement parks. Coyne is near the lake and bathing beach. Chicago's daylight saving time gives you a chance to enjoy these things by daylight.

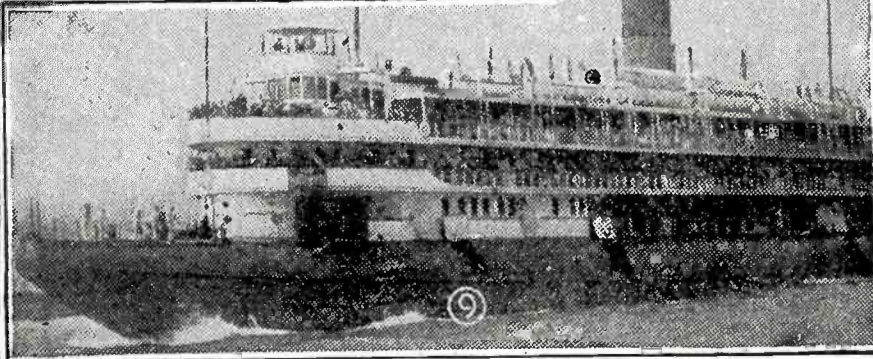

One of Chicago's Many Big Pleasure Boats

WHB

Every Radio Enthusiast and Radio Dealer is in daily touch with the GREAT SWEENEY STATION

This is one of the largest inland stations in the country and sends out official Government market and weather reports every day, besides giving musical, educational and religious programs on Sundays, Tuesdays and Thursdays. Thru the courtesy of C. G. Conn & Co., Elkhart, Ind., makers of Musical Instruments, we are broadcasting some of their concerts. This Station cost \$20,000 to erect. CALL IS WHB, 360 meters for concerts and 485 for Government reports. 500 watts W. E. set provides its power. This great broadcasting station is evidence of the capacity of the Sweeney Company to serve you in the purchase of all supplies and equipment.

Newest and Most Complete in Radio

You can be sure of getting the best service and lowest prices from Sweeney and the very latest radio developments. If you want to learn this business, to become a radio Expert or commercial operator, write for full details of the NIGHT SCHOOL now running.

The most complete equipped and thorough radio school in the world. If you want to buy a set or build your own set we can give you immediate delivery.

We Handle a Complete Line of Equipment

All parts for building your own sets, also complete receiving sets. Dealers write for information. To give you an idea of the stock we handle, we are listing below only a few of the parts necessary for installation. Write Today for complete catalog and instruction book.

Sweeney Variometers.. \$5.50	Detector Tubes..... \$5.00	Stranded Aerial Wire, 100-ft. rolls.. \$1.00
Sweeney Vario Couplers 5.00	Amplifying Tubes..... 6.50	Fada Rheostats..... 1.00
Radio Service Radio Frequency Transformers... 6.00	Federal Phones..... 8.00	3" H.R. Dials..... 1.00
Murad Radio Frequency Transformers T-11 6.00	Brandes..... 8.00	4" H.R. Dials..... 1.50
T-11A 6.50	Wesrad Amplifying Transformers... 5.00	G. A. 90° Dials..... 1.25
T-11B 7.00	Thordarson Amplifying Transformers. 4.50	G. A. 100° Dials..... 1.25
Coto Coil..... 5.50	Federal Amplifying Transformers... 7.00	Percent Twin Adapters..... 1.50
Sweeney Variable Condensers..... 3.75	Federal Plugs..... 1.75	Percent Single Circuit Jacks..... .70
Sweeney Condensers:	Federal Junior Sets..... 25.00	Percent Double Circuit Jacks..... 1.00
.00025..... .35	DeForrest Everyman..... 25.00	
.0005..... .35	Western Electric Phones..... 15.00	
.001..... .35	DeForrest Radio Home..... 36.00	
Sweeney Combined Grid Cond. and Leaks:	DeForrest Two Stage Amplifier... 35.00	
.00025 and 1 meg. ohm..... .50	Tube Sockets..... 1.00	
.0005 and 1 meg. ohm..... .50	Vacuum Gap Lightning Protector... 2.00	
Sweeney Grid Leaks:	Federal Closed Circuit Jacks..... 1.00	
.5 and 1 meg. ohm..... .25	Federal Open Circuit Jacks..... .70	
Tested Galena, mounted..... .35	Federal Anti Capacity Switch..... 2.80	
Burgess B Batteries..... 3.00	Fada Switch..... .50	
	Fada Switch, 8 contacts, 2 stops... .75	
	Fada Crystal Detectors..... 2.25	
	DeForrest Crystal Detectors..... 2.75	

Order from This Ad.

You may order any of the above described supplies, remit cashier's check or currency or money order. You are assured of prompt shipment and complete satisfaction.

Catalog and Instruction Book

Every radio enthusiast should have a copy of this valuable book, which is just off the press. Contains new and interesting matter and descriptions and hints that will save you time and money, including hookups, showing connections of crystal, regenerative and high frequency amplification apparatus, and give you much better results. Do not buy any radio supplies until you have seen this book, as we have gone into this business on a great scale and are prepared to supply you with the best and most efficient new material at lowest prices. This book has been prepared by some of the best known electrical and radio engineers and practical instructors. Sent on receipt of fifteen cents in stamps. Get your copy today.

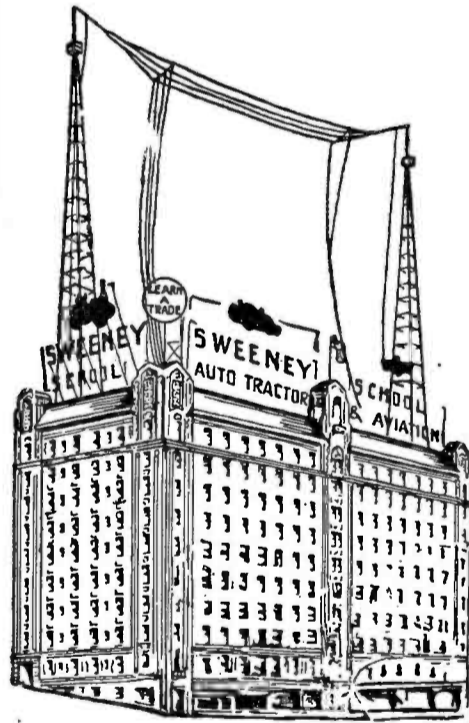

Sweeney

RADIO & ELECTRICAL CO
1021 UNION STATION PLAZA KANSAS CITY, MO.





RADIO NEWS

H. GERNSBACK—Editor and Publisher
ROBERT E. LACAULT—Associate Editor

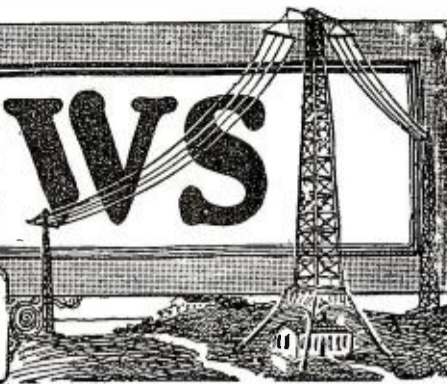

Vol. 4

AUGUST, 1922

No. 2

Ever Changing Radio

WE know of few things that change and progress as rapidly as radio. The art which is only 25 years old, has in this period of time changed much more rapidly and more radically than any other art or science. If we look at the development of the electric lighting, the electric telegraph, the electric telephone, we are struck with the fact that there have been a great many modifications, and changes are still going on; but there never have been any quite so violent and radical as those which we have witnessed in radio since the art was first developed.

Take, for instance, the telephone, which has not been greatly changed in the last 15 or 20 years, nor has there been much improvement made. The same is the case of electric lighting, which art has become so stabilized that there have been no radical changes during the past 15 or 20 years, if we except the invention of the tungsten lamp.

When, however, we look back upon radio of 25 years ago, and compare it with what we have today, it is almost impossible to make comparisons. At that time, we had the spark transmitters. First we had Marconi's spark coil; then we graduated to the transformers which still gave us a spark. After a while we added the rotary spark gap and still later our commercial companies put out the Goldsmith generator, which in turn, after a few years, was displaced by the Alexanderson generator which is still doing service at the present time. When from 100 to 500 K. W. is required to hurl signals across oceans, the Alexanderson generator is doing valuable work; its doom, however, has already been sounded.

Dr. Langmuir recently developed a power vacuum tube where a single tube can take care of 50 K. W., a tremendous energy. These tubes are being built right now, and as they are made of quartz, are not only vastly cheaper than the cumbersome alternator, but are ridiculously small when compared to the present-day generators.

We may safely predict that in another 15 or 20 years our present-day trans-Atlantic stations will have their machinery housed in small rooms, the maximum size of which will be about 25' by 25'. We all know that the trans-Atlantic stations of today have large power plants and require vast buildings to house all the machinery; this will soon be a thing of the past. There is no question that our next generation will see a trans-Atlantic station where the entire power equipment is no larger than an ordinary office desk. As a matter of fact, the new Langmuir power tube, which handles 50 K. W., is not much larger than a desk drawer. Of course, we still need machinery to develop the electric current, but the day is surely coming when, by means of a bank of tubes of this kind, and some other appliances, the power will be taken from the ordinary lighting circuit, thus doing away with generators.

When Marconi first started out, the wave-length of his apparatus was not more than 20 to 30 meters. From that time on we have increased the wave-length of our transmitters more and more, until the wave-lengths of the various trans-Atlantic stations have run up to as high as 20,000 meters. Then recently, the broadcasting stations gradually reduced these high wave-lengths until at the present time 360 meters is used. Marconi is now not only going

back to his original short wave-length, but is even "going it one better" by reducing the wave-length of his new apparatus to one meter and less.

He found that by means of this very short wave-length it is possible to direct a beam of waves in any direction desired by means of a reflector; such short wave-lengths carry just as well as the longer ones. Indeed, he reports that with the one meter wave-length, audible speech has been transmitted for over 20 miles. Great and wonderful things in radio will be accomplished in wave-lengths below one meter.

What wonders there are in store for us when we begin to send out radio waves of a few centimeters or even less, no one can foretell. The low wave-length is as yet not explored and presents vast and astonishing possibilities.

When radio was young, we spoke of the ether as a medium for the propagation of the radio waves. We were sending messages through the ether which was thought the universal medium in which the waves were propagated, but lately our scientists have become wary of mentioning the ether. They find that the ether no longer is necessary for the propagation of electro-magnetic waves, but that one can imagine waves being hurled through an absolute void just as readily. Once we become entirely emancipated from the ether make shift theory, radio will no doubt progress even more than it has in the past.

Tesla has always maintained that radio waves do not travel above the earth, following the curvature of the earth, but rather go through the ground. He has steadfastly maintained that all radio waves pass through the earth and water and that if we must have an aerial, the latter acts as a condenser. Slowly our radio scientists are becoming convinced of the truth of this, and if proof were needed, we would only have to point to the Rogers underground aerial, now in use. The day is coming when no aerial will be used, and this day is not as far off as some believe.

The make shifts of using the lighting system as an aerial will be forgotten ten years hence. We will simply attach our receiving outfits to the ground or radiator and reception will be as good or better than that obtained today. Even now, use is made of condenser aerials consisting of a number of large plates and the ground. All these things, however, are make shifts and when the time comes for us to use nothing but the ground, there is no question that our radio circuits will be revolutionized considerably.

Regarding our apparatus, we need not mention how they keep changing; evidences of this are so apparent. The tendency seems to be for radio receiving apparatus to become smaller and smaller as time goes on. The day of the vest-pocket radio outfit is surely coming as the public insists on smaller and smaller apparatus. Just where all this change will stop, no one can foresee. It seems to be a hopeless task to standardize the radio business, and it may be generations before the art finds itself and becomes settled, as are other arts and industries.

It seems certain that the present conditions of changes and more changes will continue for at least ten years and perhaps longer.

H. GERNSBACK.

Radio Instructions at Camp Alfred Vail, N. J.

By S. R. WINTERS

THREE meals a day, comfortable sleeping quarters, medical services, amusements, a monthly stipend, and opportunities for acquiring knowledge of radio-telegraphy and radio-telephony—briefly such are the attractive inducements extended to enlisted personnel who enroll for training at Camp Alfred Vail, New Jersey, under the direction of the Signal Corps of the United States Army. And the location, expressed in terms of the time required for railway trains to span the distance, is one hour and fifteen minutes from New York City—a consideration for stu-



structors, offering a vast knowledge from the richness of their experience and observations, is supplemented by lectures from wizards of electricity engaged by private corporations. Representatives from the General Electric and Western Electric Companies visit Camp Alfred Vail at intervals and enliven the keenness of students in quest of electrical knowledge by lectures on the subject from a decidedly practical viewpoint.

The teaching of lessons in wireless communications at the Signal Corps School, obviously, involves the laying of a basic foundation for those who may

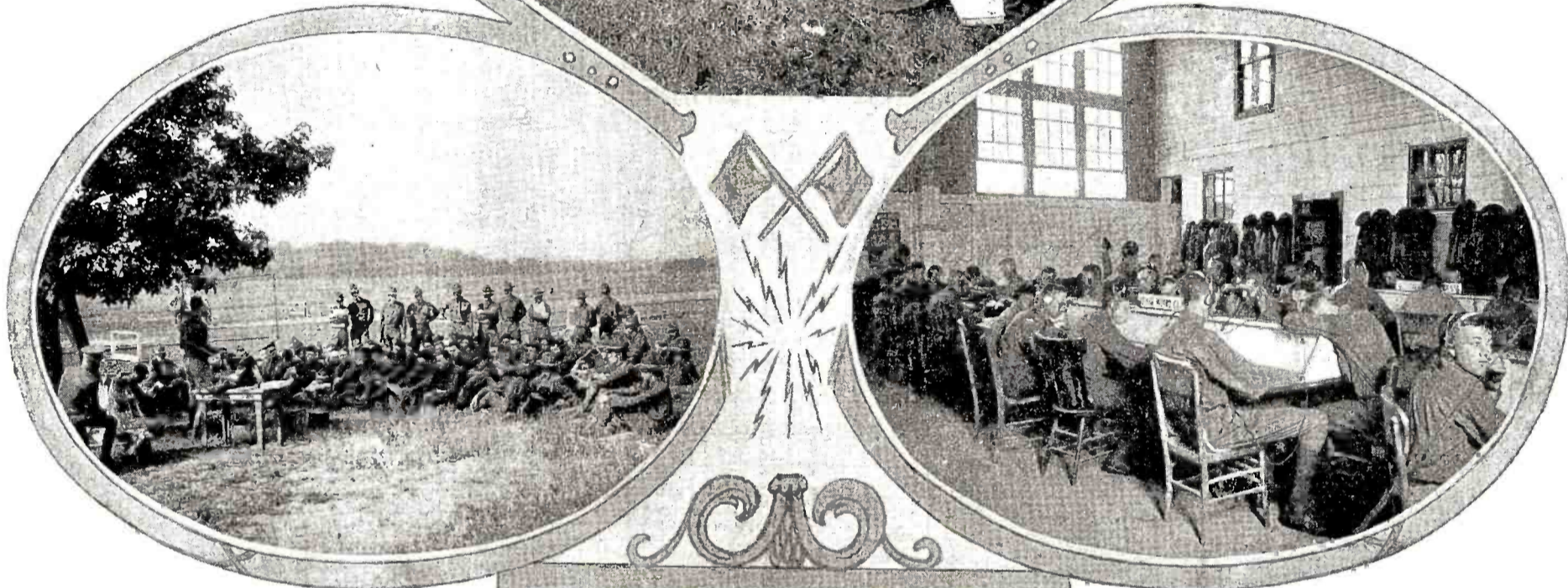

dents imbued with the allurements of the bright lights and cosmopolitan attractions.

Camp Alfred Vail is situated at the old Monmouth race course, and its identity as an athletic center is retained to a considerable degree. Here, each recurring summer the polo teams of the United States Army match their wits and battle for supremacy in the military game in which a ball is maneuvered between two goals by contestants on horseback. Practice in pistol shooting, opportunities for acquiring proficiency as swimmers at a nearby bathing beach, athletics in a variety of forms, and social festivities at a magnificent service club, are among the diversions that relieve academic instruction of its monotony. Such is the pleasurable environment, amid which students seek knowledge of the wonderful wireless waves.

When this article is being written, May 15, 1922, 46 officers and 192 enlisted men in the service of the United States Army are pursuing courses that bear directly on the art of radio-communication. Officers submit themselves to a rigid training, involving the pursuit of two outlines of study—one consisting of the fundamentals of electricity and military science, and another comprehending the technicalities of radio-telegraphy and radio-telephony. The general outlines of studies at Camp Alfred Vail include such subjects as radio electrician, telegraph electrician, radio operator, telegraph operator, linemen, and field telephone. The course of training, a completion of which qualifies a student to be labeled as "radio electrician," has a duration of ten months. Other periods of training, for instance a course which qualifies a student to become a lineman, may be finished in five months.

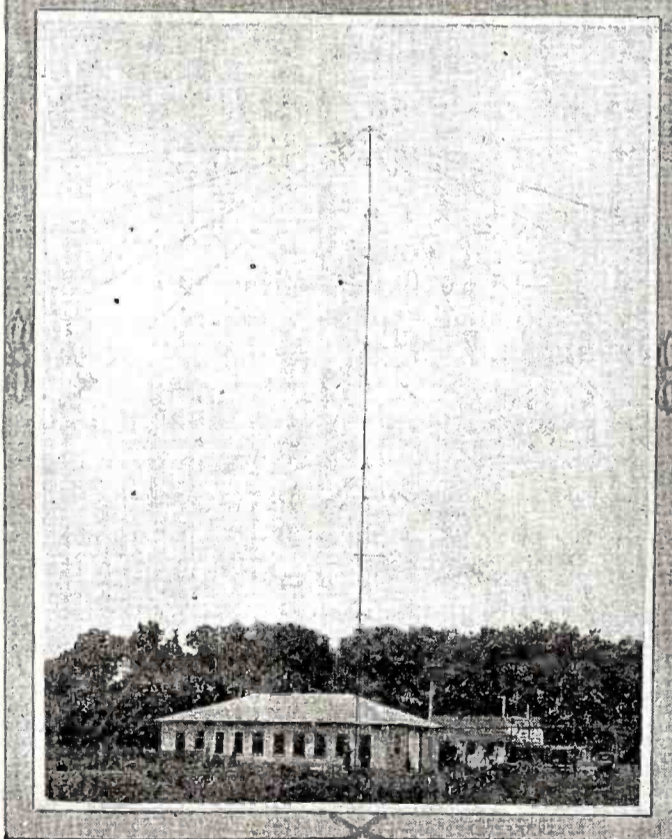

The Top Photograph Shows a Field Station in Operation; Note the Counterpoise Laying on the Ground. Below is the Building and Mast of the Fixed Station. On the Left, Open Air Class, the Demonstration of a Loop Aerial Set which is Adapted for Trench Use. On the Right, the Code Class where Operators are Trained.

The Signal Corps School at Camp Alfred Vail, New Jersey, is under the supervision of the training section of the Washington office, which is in charge of Major Paul W. Evans. The school is personally directed by Lieutenant Colonel J. E. Hemphill, who in this connection bears the title of commandant. Sixteen officers of the United States Army comprise the teaching faculty. The competent guidance of this staff of in-

not be familiar with the principles underlying radio communication. Or, differently expressed, the rudimentary facts about the transmission of communications by electromagnetic waves through ether or space are presented at the outset of the courses of study. Simple ways of instruction are employed, involving explanation of magnetism in crude form, such as lectures on the lodestone, horseshoe magnet, bar magnet, poles of a magnet, and the earth's magnetism. Instruction by analogy proves to be an effective method. The commonplace things of the street, office, or home are translated into terms by way of making clear phenomena of electrical transmission. For example, the pendulum of a clock, when swinging freely and then permitted to halt gradually, may be compared to the motion of the oscillatory discharge of an electrostatic accumulator in a radio closed circuit. Fundamentals are securely entrenched in the minds of the students before the more difficult problems of electric-transmission are attacked.

Just as the baby learns to walk by piecemeal, students of radio-telegraphy and radio-telephony go from the known to the unknown, step by step. The outline of the course is something of this order: Magnetism and electro-magnetism, static and current electricity, generators, motors, primary and secondary batteries, internal combustion engines, practical laboratory, alternating current and alternating current machinery, measuring instruments and measurements, radio power circuits, practical laboratory, oscillatory circuits, damped wave transmitting sets, undamped wave transmitters, radio regulations, vacuum tubes, receiving apparatus, practical receiving, high

(Continued on page 322)

Station PCG at Sambeek, Holland

By J. THISSEN

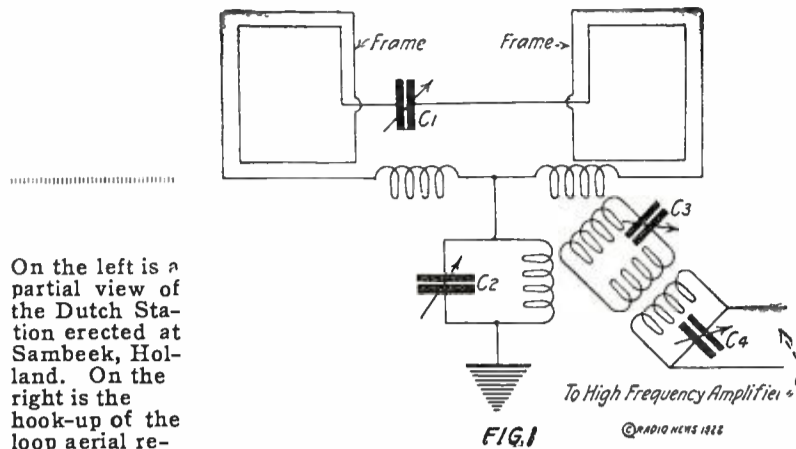

On the left is a partial view of the Dutch Station erected at Sambeek, Holland. On the right is the hook-up of the loop aerial receiver having uni-directional properties.

energy is said to be the result of an invention of an electrical engineer named Idzerda, president of the industry, who has applied for U. S. patents. The company is conducting part of its correspondence with its customers by radio.

The Marconi Wireless Telegraph Company's recent tests of combined wireless and wire communication between members of the English Anglo-Batavian Society speaking from the Marconi House in London, and members of the Nederland-Engeland Society at Amsterdam, speaking from the Stock Brokers Society, may result in the establishment of a combination wire and wireless system connecting the two countries.

Today the only concern engaged in the manufacture of radio telephone transmitting equipment there is the Netherlands Radio Industry at the Hague. The company produces about 500 sets a year, but is not operating at capacity today, as the demand does not seem to be great, although foreign inquiries are coming in, including some from the United States.

An Early Radio Set

The illustration below shows one of the earliest types of radio receiving apparatus used by Professor Hughes in his experiments in wireless communication many years ago.

This apparatus is part of a collection that is being made in England of the apparatus used by the early experimenters in the development of the art of radio. The instruments used by Mr. Marconi, Professor Lodge and others will be included in the collection. This interesting museum will be exhibited to the public and, contrasted with present-day apparatus, will indicate the marvelous progress which has been made during the last decade.

I SHOULD be very pleased to have published in RADIO NEWS the enclosed photos of the long-distance receiving station at Sambeek, Holland, call PCG, where I am operator. One photo shows a rotating frame aerial in use at this station for experimental purposes.

PCG is the Dutch receiving station for direct communication with Bandoeng (PKX) Java, Dutch East Indies, a distance of over 11,000 kilometers. The frame aerial is 3½ meters square and has 40 turns of bare wire. The hook-up giving uni-directional reception (diagram from Dr. Esau Telefunken Cy) is shown in Fig. 1. With this set, PKX can be read daily. Transmissions from PKX are from 5:40 p. m. to 10:40 p. m. Greenwich Mean Time on 8,800 M. C. W. arc. The Dutch transmitting plant for PKX and USA is located at Kootwijk, about 30 miles from the receiving station and consists of Duplex 450 kilowatt high-frequency alternators. It will be ready next September. When the station is opened for experimental transmissions, data and wave length will be given.

Fig. II shows a general view taken from the receiving station in an easterly direction and showing three of the masts, each 61 meters high.

The Government of the Netherlands is now broadcasting weather reports by radio telegraph twice daily, but is planning the installation of radio telephone service in order that farmers who do not know code can listen in.

Every 15 minutes the Amsterdam Stock Exchange sends out bulletins by means of wireless telephony, giving the ruling quotations of the exchange. When the exchange is closed a press bureau makes use of the broadcasting system for the distribution of domestic and foreign news, as well as foreign exchange and stock quotations in code.

Orchestral music and speeches are broadcasted Sundays from 2 to 5 p. m. by the Netherlands Radio Industry at the Hague. With a radius of about 600 miles, this company's entertainment is said to have become very popular in the British Isles. Experiments with only .25 amperes in the aerial and 160 watts input have carried broadcasts of both music and speeches as far as Liverpool and Edinburgh successfully. The transmission of matter with this small amount of

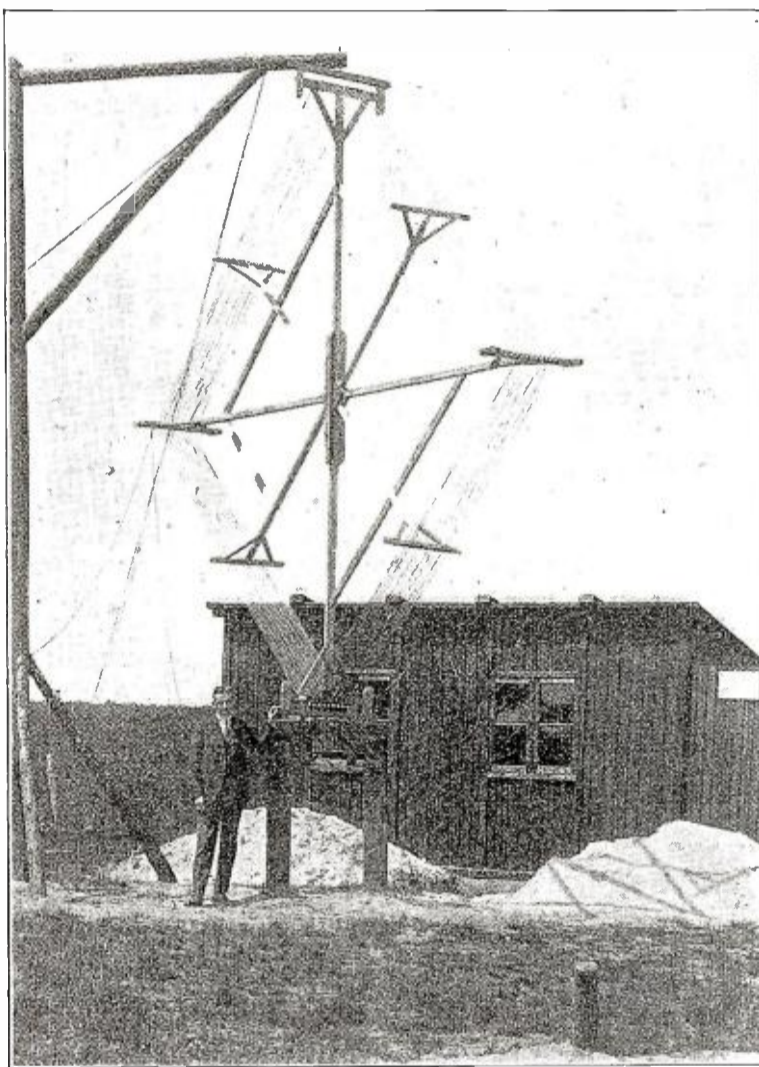

A Loop Aerial for the Reception of Long Waves Used at Station PCG.

Some of the apparatus used by Hughes for the reception of Radio Signals.

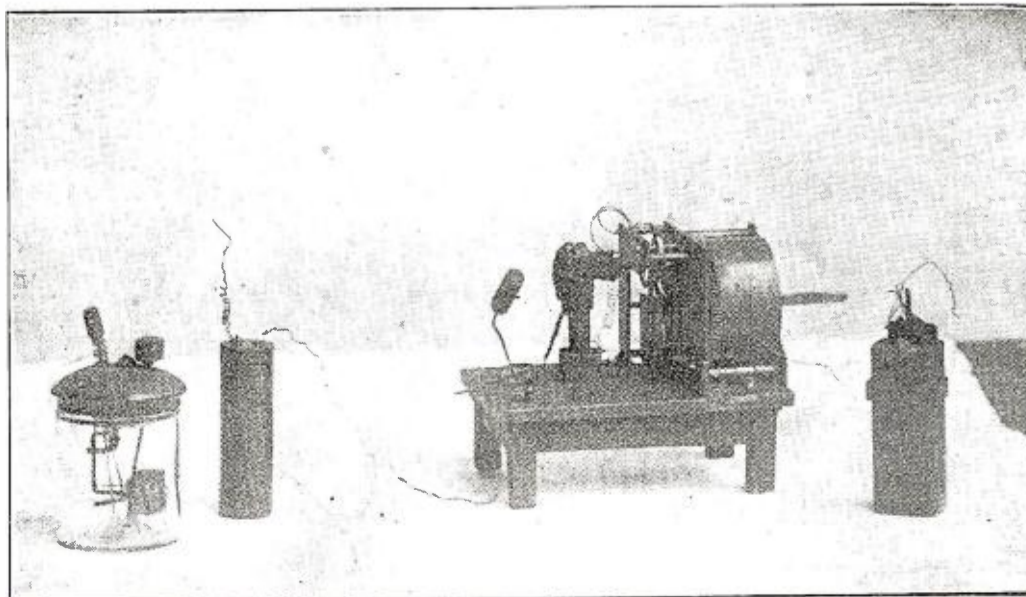

Tropical Stations of Unusual Interest

By CHARLES ADOLPH REBERGER

It is certainly true that the average radio "bug," as he sits at his instrument listening, thinks only of what is going on in the immediate vicinity, and seldom stops to wonder what is taking place in the remainder of the wireless world.

He may often think of the nearby coast stations, as their signals come pounding in, but does he ever stop to think about the big stations down in those portions of the globe, just north and south of the equator, which might be termed "the tropics"? As we are all no doubt aware, it is in this portion of the universe that static reigns supreme during nearly every month of the years that come and go and especially during the unbearably hot mid-summer months, when it attains such a state that communication with vessels and other land stations, although they may be within a radius of 200 miles, is made very difficult, giving the operators on watch an opportunity to display their receiving abilities. Most of the time, the dots and dashes forming various characters of the alphabet will be blotted out with each crash, thereby making it almost impossible to make out the words and figures constituting messages and often has an unpleasant effect upon the operator himself.

As recent tireless experiments have disclosed, the present day radio engineers are busy perfecting a really efficient eliminator and each day they become more confident that their labors will be rewarded. Then the ship radio man, as well as the land operator, will have no need to fear this horrible setback. His stay down in this land of dreams will be one of joy, instead of one of worry—whether it be winter or summer—rain or shine. It will then be a simple matter to get his traffic off, except that he will be compelled to contend with the usual QRM, but what is this compared to working through a static storm? As everyone knows, who has had the opportunity of sailing in tropical waters during July and August, it is not a simple matter to raise the coast stations, for the operator here, like the average ship operator, does not fancy keeping the phones clamped to his ears for hours at a time, just listening to static pounding in, and then again a ship may not call him for some time, because of the prevailing static conditions which are certain to give him considerable trouble.

There are no land stations which attract so much attention as those in the extreme south, owned and operated by the United Fruit Company, for it is here we find real stations and radio men who are operators, capable of sitting for hours at a time, intercepting message after message, regardless of static or interference. Until many years have been spent in the wireless game, one would not find himself eligible for a position. All the men at these private stations must know the "game" from start to finish, for upon their shoulders rests a great

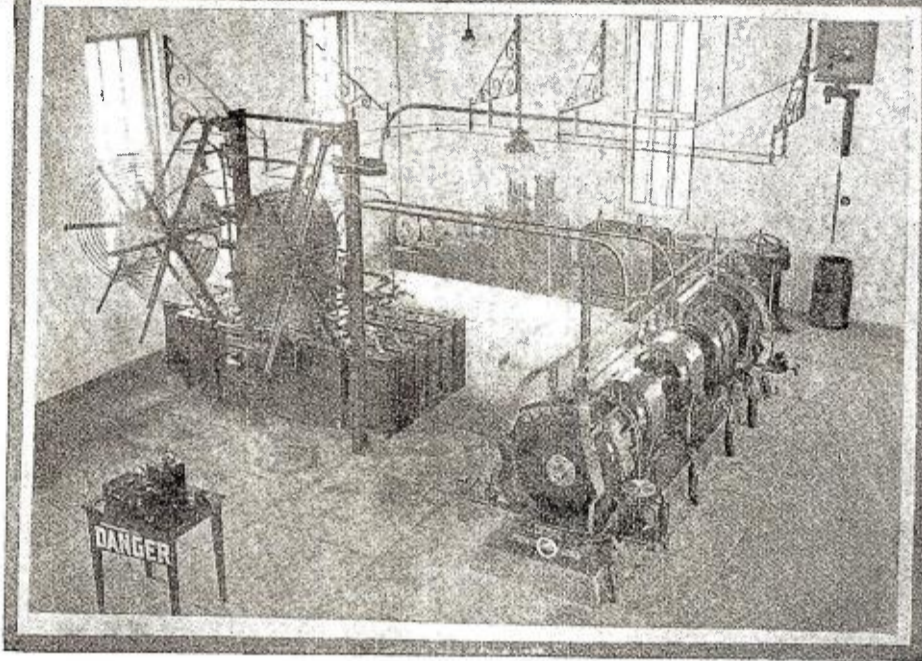
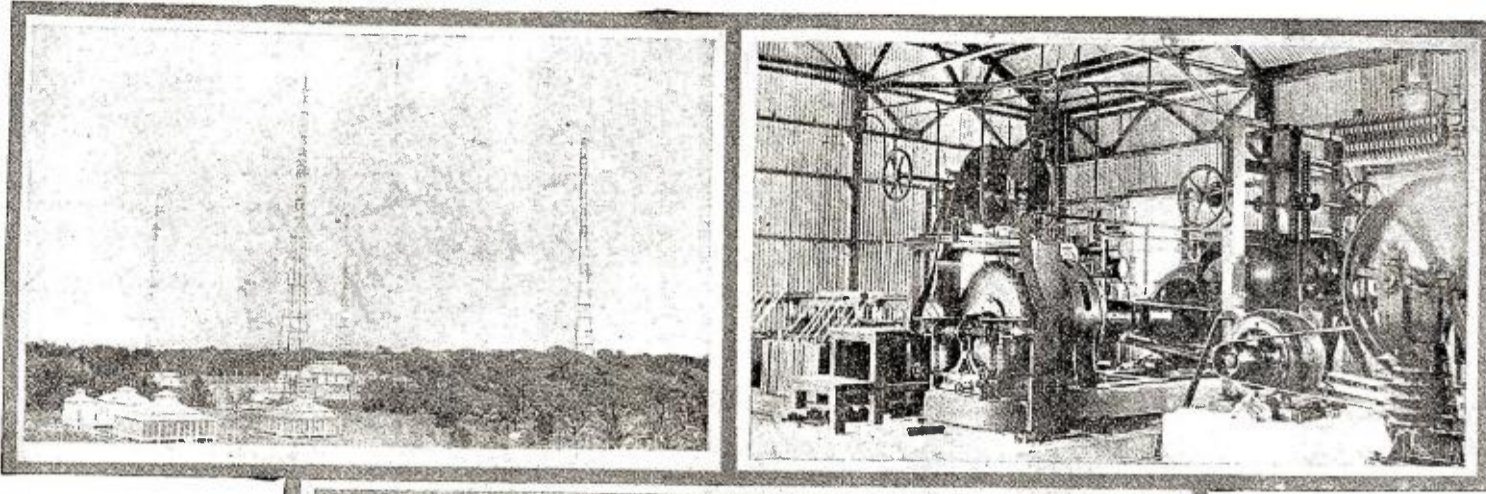

Above are General Views of a Tropical Station and the Inside of the Power House. Note the Large Rotary Spark Gap and Inductance Mounted Above the Alternator. On the Left May be Seen the High Tension Condensers. The Lower Photograph is That of the Transmitting Room of Another Station.

responsibility. Let us turn our attention toward Swan Island, Almirante, Santa Marta or Limon. It is seldom that a vessel stops at these ports and therefore it would

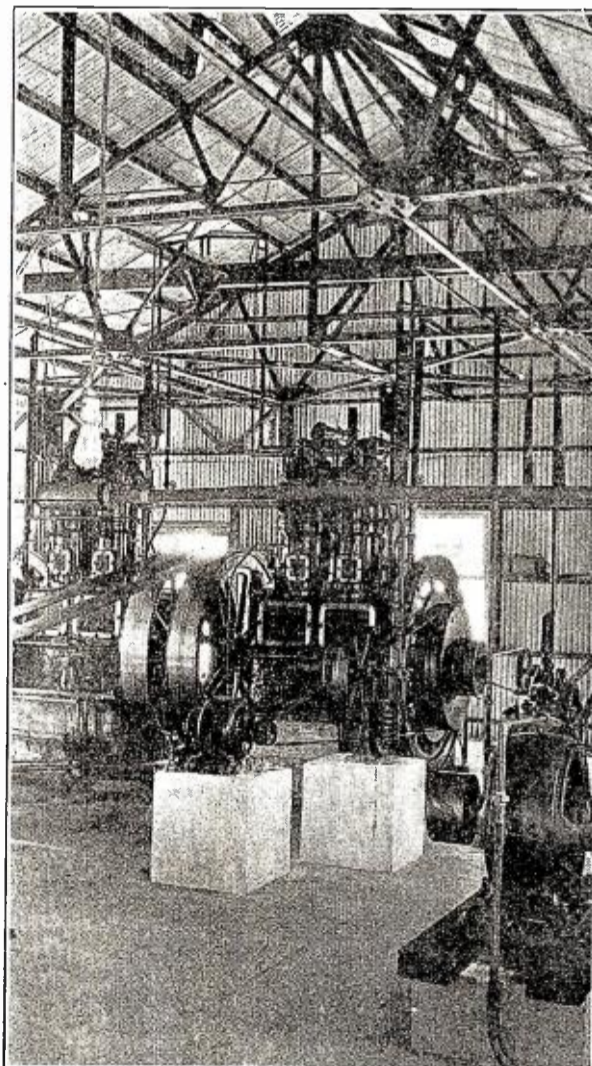

The Diesel Engine Furnishing the Power at the Station Shown Above

require considerable time to send for various parts, if the operator did not possess the ability and knowledge to make repairs, in the event of a breakdown. The practice of throwing away parts

which are thought useless is prohibited, for we must stop to consider that one cannot go out at any time of the day and purchase a certain item, as in New York, for instance; in the tropics a radio store is unknown.

The 50-K. W. station at Swan Island (Caribbean Sea), known in the radio directory as "US," is of special interest. Although a mere dot in the Caribbean, it has played a notable role in the linking together of the Americas. Each day special working schedules are adhered to and working on a wave-length of 2950 meters, numerous messages are transmitted between here, New Orleans (WNU) and stations in Central America. Four steel frame type towers, almost 300' high and spaced 600' apart, support the enormous antenna. In erecting these towers special emphasis

was laid on the question of their construction, for they must be able to stand undaunted, against the terrific gales that sweep across the blue Caribbean each year.

The special generating system, included in the equipment of the station, is housed in a large building set back from the main house. From the operating room it is impossible to govern the engines and so it is necessary that someone go out and set the gas engines in motion each time it is necessary. A valuable feature at this station, is the system of remote control on the 5-K. W. set. The transmitter is of the panel type, the rotary gap being made fast to the generator shaft. By simply throwing the wave-length switch, it is possible to carry on transmission on a wide scope of wave-lengths. It is similar to the Navy 5-K. W. set with which many of us are familiar.

Should we sail due southwest from "US" and visit the boys at Limon C. R., we would find things about the same, regarding the working of the station and the manner of living. The eight-wire aerial, identical to those in evidence on the well-known fruit ships, is supported by two 200' towers, of the type at Swan Island. At the base of the northernmost tower is located the building in which is incorporated the operating room and living quarters, while only a short distance away, is the open sea, where, in their leisure hours, the operators can enjoy fishing, swimming, etc. By going into the mountains on the other side of the "town" they can indulge in hunting animals of many kinds.

The 5-K. W. generator, at one end of which the rotary is made secure, is installed in a small separate structure, together with the condensers, switchboards and five-foot oscillation transformers. It might be stated that transmission at Limon is carried on, on a wave-length of 1,800

(Continued on page 327)

Seven New Radio Stations Have Combined Power for Transmitting 46,750 Miles

A COMMUNICATION originating at Cavite, Philippine Islands, may be received at Goat Island, in the San Francisco Bay of California—more than 6,000 miles apart—within a fractional part of a second or in the course of the twinkling of an eye. Electromagnetic waves travel at a speed of 186,300 miles a second, and if the reader desires mathematical precision, the calculation as to the exact percentage of a second required for a message to bridge this distance may be readily determined. For practical purposes, however, the transmission and reception of the communication are instantaneous. Moreover, this rapid, long-distance exchange of intelligence is not an erratic performance. Continuous and reliable communication is an accomplished fact between California and the Philippine Islands.

All of which might lead one to infer that the outer fringes of the world itself are the limits of radio-telegraphy as a vehicle for exchanging communications. In reality, however, the Goat Island wireless station is probably the only one in the world where reliable reception of radio-telegraph messages is maintained for a distance exceeding 4,000 nautical miles. Immunity from atmospheric disturbances, an insistent annoyance elsewhere during the summer months, is a peculiar condition favoring the location of the California radio-telegraph stations of the United States Navy Department, making possible long-distance communication without interruption. Dr. L. W. Austin, head of the radio research laboratory of the United States Navy Department, finds in this example substantial proof that static electricity or atmospheric disturbance is directional in character.

The freedom of Goat Island from the disturbing influences of static electricity, a condition determined by a series of experiments conducted by the Navy Department, led to the recent introduction of a uni-directional system of reception of radio-telegraph intelligence. Heretofore, the communication traffic maintained between this point in the San Francisco Bay and the Philippine Islands was relayed through Honolulu. The elimination of atmospheric disturbances and the introduction of the uni-directional system of reception made it possible to negotiate wireless traffic without interruption for a distance exceeding 6,000 miles during the last summer. This is a remarkable accomplishment when it is considered that the Cavite transmitting radio-telegraph station is moderate in its power consumption, having only 200 amperes in the antenna. The improvement in reception effected at Goat Island, California, however, is equivalent to enlarging the transmitting power to 5,000 amperes in the method previously existing.

All things else equal, the accepted theory is that the distances embraced in exchanging

communications by radio-telegraphy is largely influenced by the sensitiveness of the receiving apparatus and the amount of electric power consumed by the transmitting equipment. When this formula is reasonably applied the results are not disappointing. However, in the contemplation of the erection and maintenance of seven long-distance radio-telegraph communication stations at home and abroad, it is well to ponder the question: "Is there a limit to the distance that can be covered in radio-telegraphy, or can hitherto unapproached mileage be tra-

for covering distances of 3,000 or even 4,000 miles. But when one considers the power cost involved and the expense of erecting and caring for the enormous antenna structures which will be required, there is evidently a limit beyond which it is not profitable to go. This is the more evident when one remembers that doubling the antenna current, that is, quadrupling the power, can only double the telephone current in the receiving station, or in other words, only double the signal disturbance ratio which is the real measure of communication, so that any small receiving improvement which will double the strength of signal in comparison with the atmospheric disturbances accomplishes as much as quadrupling the power of the sending station."

The seven high-power radio-telegraph stations in the course of construction, or whose erections are contemplated in the not remote future in America and European countries, anticipate covering a combined distance of 46,750 nautical miles. That is, to employ a somewhat far-fetched supposition, if these seven powerful electric reservoirs were unified as a single radio-telegraph transmitting system, its capacity to send a communication could be reckoned in figures approaching 50,000 miles. Aside from this imaginary combination, each of these huge transmitting stations contemplates spanning a distance not hitherto consistently effected. At present, the most powerful electric reservoir for dispatching wireless messages is located near Bordeaux, France. Of ranking import in magnitude is a station at Nauen, Germany. The latter is classified as the veteran high power alternator station, having been in operation continuously since 1914. Both of these stations will be surpassed in sending capacities upon the completion of the ambitious building program in progress.

The Federal Radio Telegraph Company of San Francisco, California, is planning the construction of two immense arc stations at San

Francisco and Shanghai, the distance intervening being 5,300 nautical miles. The towers of these structures will extend skyward for a distance of 1,000 feet. The arcs will have a capacity of 1,000 kilowatts, yielding antenna currents of 600 or more amperes. The wave-length will probably range from 20,000 to 30,000 meters. "The problem of regular communication at such a distance is very difficult, at least in regard to the reception at Shanghai," is the expressed opinion of the head of the radio research laboratory of the United States Navy Department. "As has already been said, San Francisco offers remarkable facilities for receiving on account of the peculiar directivity of the atmospheric disturbances which permits them to be practically eliminated in reception from

(Continued on page 322)

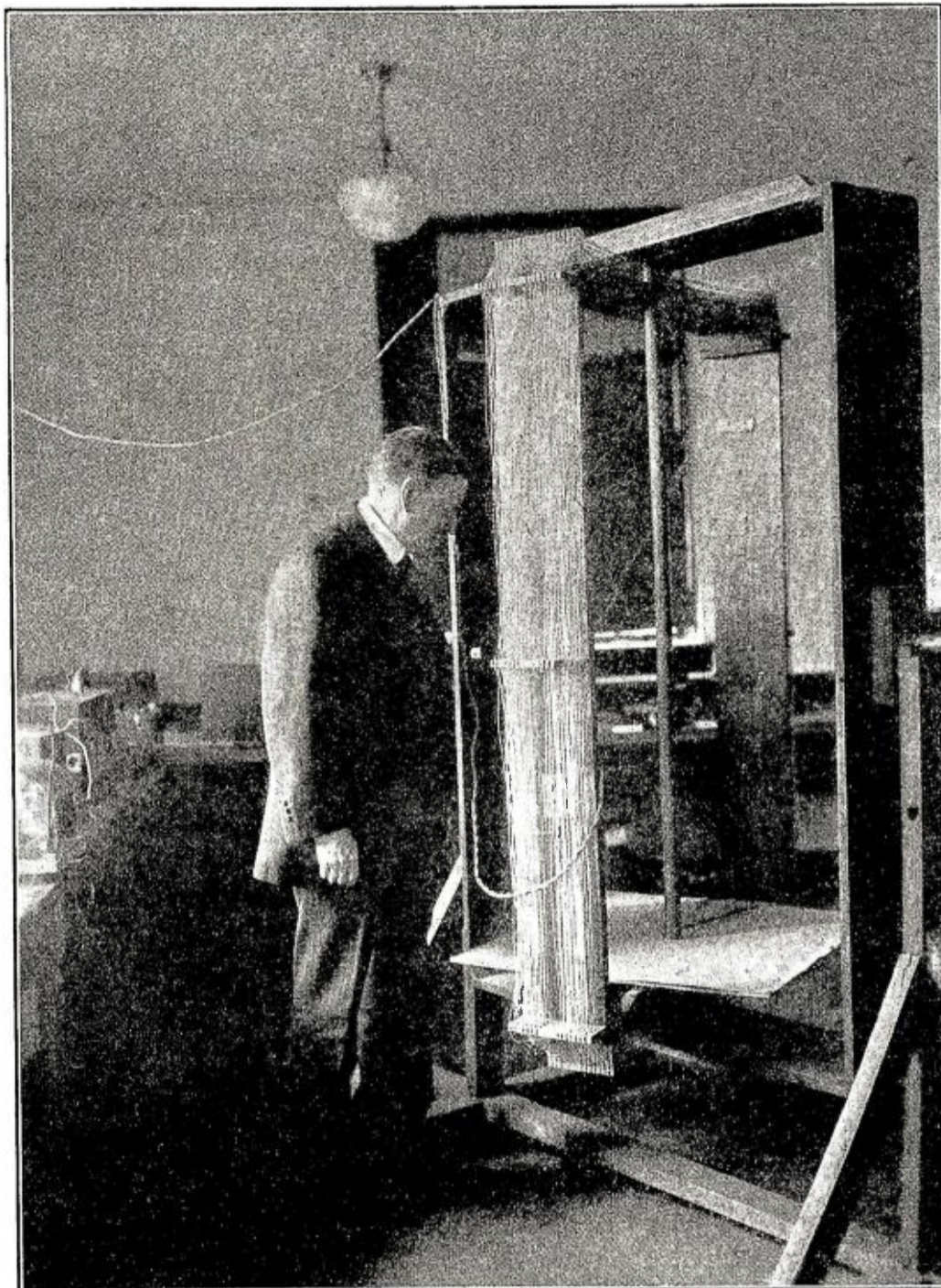

Dr. L. W. Austin, Head of the Radio Research Laboratory of United States Navy Department, and the Loop Aerial with which He Conducted Tests at Goat Island, Calif. This Station is Capable of Receiving Communications Continuously from a Longer Distance than Any Other Station in the World.

versed with reasonable assurance that constant and reliable communication can be established?" For instance, it is proposed to erect a wireless station that will span the distance between Berlin and Buenos Aires—a distance of 6,400 miles.

Dr. L. W. Austin, an international authority on long-distance communication, is a bit skeptical about the prevailing belief that few limitations need be contemplated in the erection of high-power radio-telegraph stations. "As to the future of long-distance radio, the distances which can be covered in radio-telegraphy have always been limited by the receiving apparatus, and I see no reason to believe that this will not continue to be true in the future. At present, there is a tendency to attempt to solve the problem of transmission by the use of enormous power, and it is possible that this can be done

Radio-Telephotography

The Dieckmann Process for the Wireless Transmission of Drawings, Etc.,
and Its Applications in Aviation

By DR. ALFRED GRADENWITZ

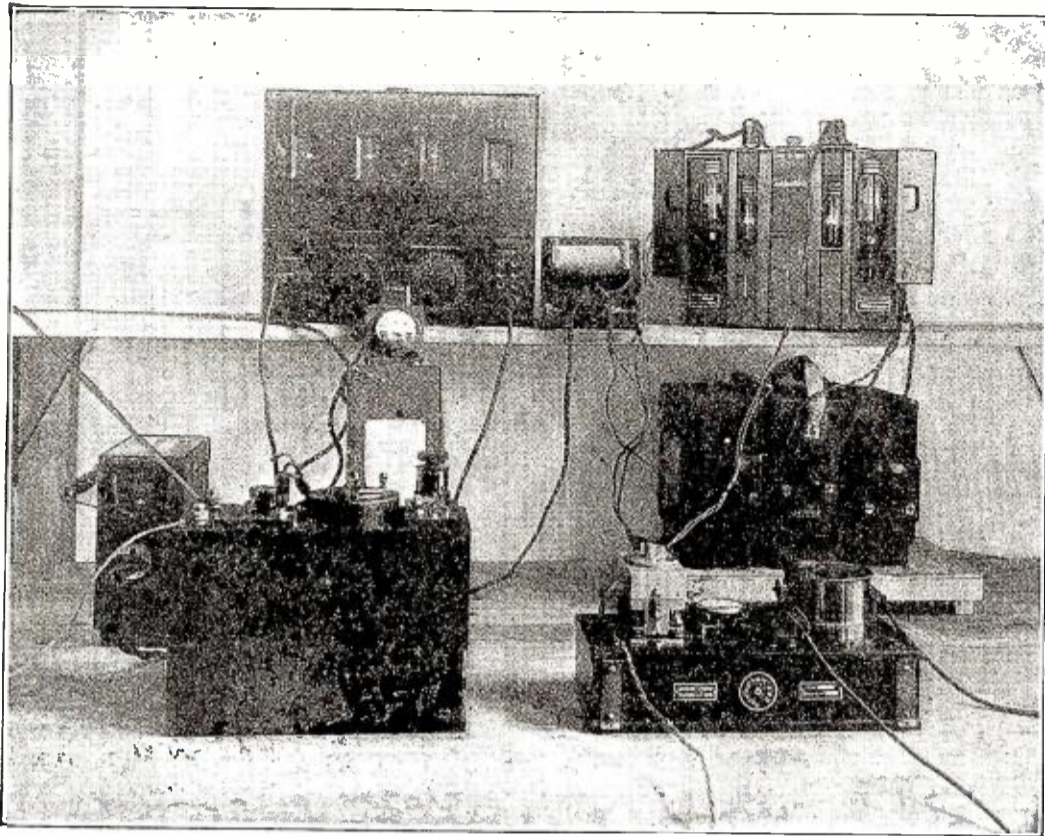

On the Left is a View of a Complete Station for Sending and Receiving Pictures by Radio; on the Shelf are the Amplifiers and in the Fore-ground the Transmitter and Relay.

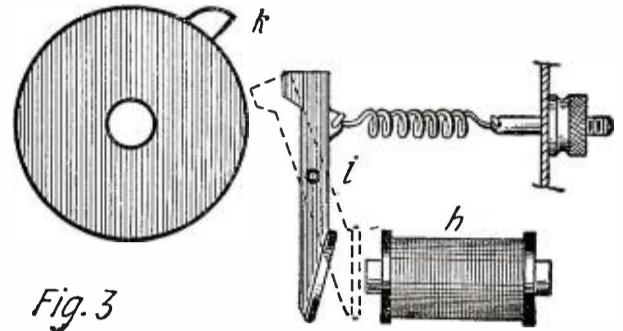

Fig. 3

Now, in order not to have to use two forms of current—differing as to their intensity, direction, wave-length, etc.—for actuating the synchronizing device, on the one hand, and reproducing the original picture, on the other, Dr. Dieckmann uses the following ingenious arrangement:

Of the total time available for each rotation of the cylinder, part is used exclusively for picture transmission, and part exclusively for synchronizing. Figs. 2 to 4 will serve to make this clear. For the sake of simplicity, Fig. 2 has been drawn on the hypothesis that the receiver and sender communicate directly over a wire, it being, of course, immaterial whether the recorder receives its impulses over a line of conductors or by wireless from a radio station. The dotted sections of the line in Fig. 2 should, therefore, be replaced by the organs of wireless transmission.

As seen also in Fig. 1, the sending cylinder *b* is set rotating by a clockwork *a*, the contact device *c* being at the same time shifted so as to explore the circumference of the cylinder *b* along a spiral (helical) line, a current being closed or opened in accordance with the conductive or non-conductive condition of the various portions of the picture. The clockwork at the receiving station will, in a similar way, set the shaft *d* rotating, which through the friction clutch *f* carries along the receiving cylinder *g*, unless this be stopped by a locking device.

This locking device, as represented apart in Fig. 3, comprises an electro-magnet *h*, a stop lever *i* kept back by a spring, and a cam *k* rigidly connected with the receiving cylinder. The current at the receiving end simultaneously flows round the electro-magnet of the recording style *q* and that of the locking device *h*.

When no current is flowing through the electro-magnet, the receiving cylinder *g* is free to rotate, and the same will be the case if some current flowing through the electro-magnet *h*, the lower part of the stop lever is attracted (see dotted position in Fig. 3), provided that the cam *k* is not opposite the upper end of the stop lever. Only in case the passage of the cam in front of the upper part of

DURING the last stage of the war, the German army tried to develop radio-telephotography for the rapid transmission of drawings, sketches, reports, etc., from aeroplanes to stations located on the ground or on board ship. Inasmuch as the Armistice luckily cut short all war-like pursuits of the "civilized" world, these tests were not followed by any practical realization, but the method seems to be a good one and is likely now to be put to peace-time applications. This is sufficient reason for our placing an account of it before our readers:

The method is the invention of Dr. Max Dieckmann, director of the Research Laboratory for Radio Telegraphy and Atmospheric Electricity at Grafelfing, near Munich, and can, of course, with but slight alterations, be as well adapted for telephotographic transmission over telephone or telegraph lines. Figs. 1-4 show the arrangement of the transmitting and receiving stations as well as of the synchronizing device.

The sending station comprises a standard sender for damped or undamped waves. A telautographic transmitter is connected up in parallel to the key. This consists of a clockwork *a*, which drives a cylinder *b*, carrying at its circumference the picture to be transmitted, and a contact style *c* which, as the cylinder is turning, explores the picture in an helical line. The cylinder and contact style are connected up to the key either directly (in the case of small senders) or (in the case of big senders or if an inversion of the picture from "positive" to "negative" is desired) through the intermediary of a relay *R*. Inasmuch as the picture, etc., is drawn with conductive ink, the circuit will be closed and a train of waves sent out into space, each time the style is in contact with some portion of the picture.

The antenna at the receiving end is connected up to a standard receiver for damped or undamped waves working on a telephone over a sound amplifier. The telautographic receiver is inserted in the place of the telephone receiver or in parallel to it and, like the sender, mainly consists of a clockwork *d*, a cylinder *g* driven by the latter and carrying at its circumference the recording paper, the recording style *q* and, finally, an arrangement for "synchronizing" the sending and receiving cylinders, i.e., for insuring uniform work-

ing of the two cylinders. Connection with the amplifier is not made directly, but through the relays *R*², *R*³ and a rectifier. A short description of the synchronizing device is given in the following:

According to the D'Arlicourt principle, the uniformity of working between the send-

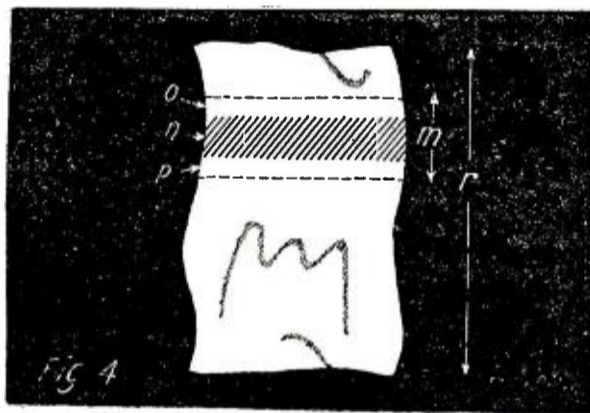

A Developed View of the Cylinder Showing the Marks Used for Synchronizing the Receiving Apparatus

ing and receiving cylinders is, in the case of telautographic methods, generally obtained by causing one of the cylinders to complete each rotation slightly before the other, arresting it the time required for the other cylinder to make up for its delay and, eventually, releasing it by the action of an electro-magnet.

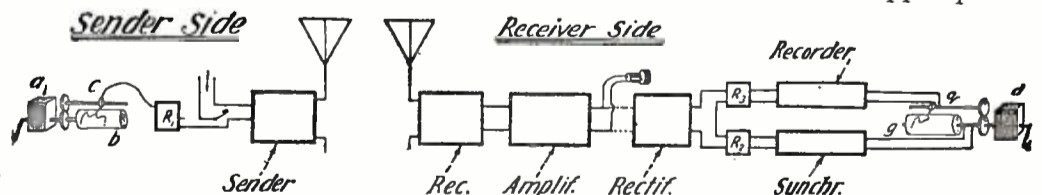

Fig. 1

These Sketches Show the System of Picture Transmission by Radio and Line Telegraphy. It Was Developed During the War for the Needs of the German Army.

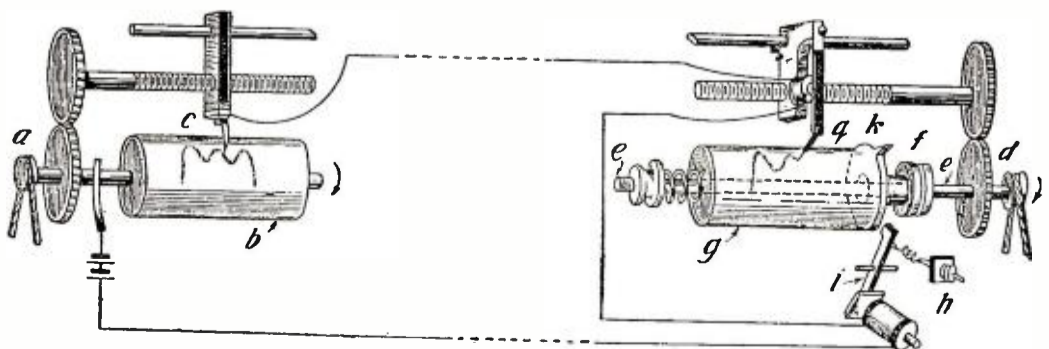
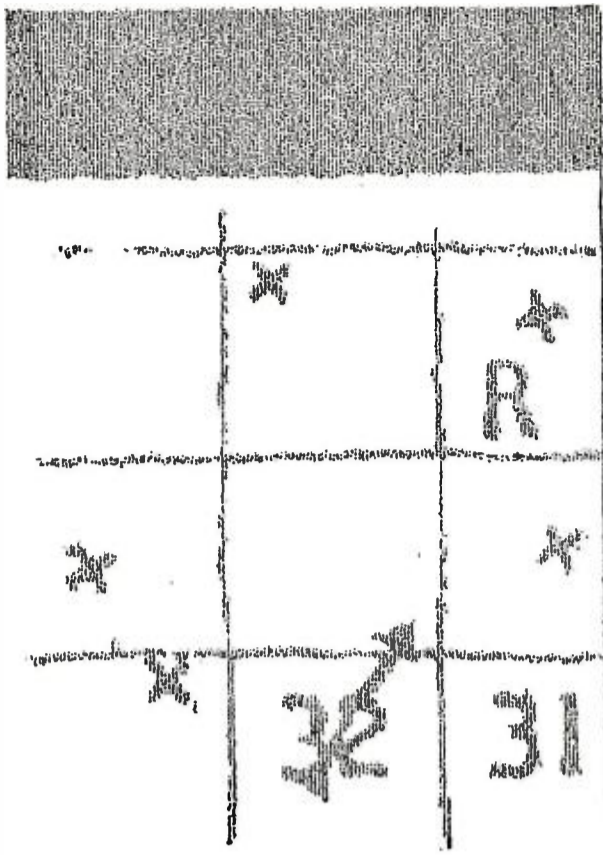

Fig. 2



This Chart Represents the Ground Divided into Squares with the Position of Guns as Seen from an Airplane. This Picture was Sent from an Aircraft to its Base by Radio.

the lever *i* coincides with the excitation of the electro-magnet *h*, will the receiving cylinder be stopped, the time taken by the current through the magnet *h* to cease and by the stop lever *i* to be released by the spring.

A band of a width corresponding to *m* (Fig. 4), and transversal to the direction of rotation, is, on the receiving cylinder, reserved for synchronizing. This band comprises three sections, the central picture section *n* lying between two sections *o* and *p* free from any telautographic reproduction. The width of the central section should be such as to make the time required for passing through it greater than any possible difference in the working of the two cylinders.

While the sending cylinder is rotating, current impulses will be sent out in a sequence corresponding to the conductive or non-conductive portions of the picture the style is sliding over, and these impulses will in the receiver both actuate the recording style *q* and excite the magnet *h*. If the cam *k* then has once been stopped by the stop lever, while the contact style *c* was sliding over the picture section *n*, it will with the next revolution again find the stop lever *i* ready to stop for the synchronization, provided that the width of *n* is sufficient in proportion to the necessarily higher number of revolutions of *g*. If there is a possibility of the receiving cylinder *g* rotating at double the speed of the sending cylinder *b*, the band section *n* will have to be of a width more than half the height *r* of the picture. If the possible difference in the rotation of the two cylinders is less, *n* may, of course, be chosen narrower in proportion.

Schrift erzeugt mittels Funken durchschlag durch leichtschmelzbare Farbe.

The Writing Sent by the Process Described in this Article is Quite Readable and Instructions may be Sent by this System Which are not Understandable to Any Station but the One to Which it is Sent as Both Apparatus are Synchronized.

This synchronizer is so safe in working and so substantial that ordinary gramophone motors with coarse regulators may be used to drive the sending and receiving cylinders.

As regards, finally, the production of electrically conductive (or non-conductive) drawings to be used for transmission to a distance, a number of methods have been suggested, the use of "fat" pencils for drawing on non-varnished metal foils having proved quite suitable. On the other hand, there was no simple method available for the immediate reproduction of colored marks at the receive-

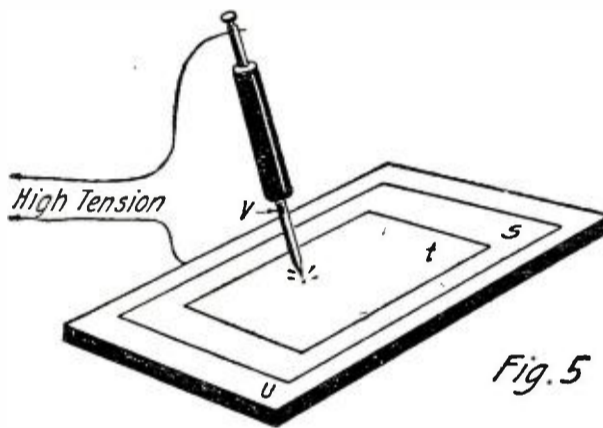

This Sketch Illustrates How Colored Pictures may be Sent by Radio by Means of Special Papers Supporting Some Colors Which are Melted by the Heat of a Spark Passing Through.

ing station. Dr. Dieckmann, therefore, designed a new process allowing colored marks to be produced in a most simple manner and which would seem to be suitable also for a number of other purposes. Fig. 5 will make the underlying principle clear.

To the recording surface *s* there is applied a thin paper or tissue *t* coated with a layer of an easily melting color, which is turned toward the recording surface. Below the recording surface there is placed the conductive lining *u*. If now a small electric spark be made to pass between the point of the recording pencil *v* and the lining *u*, the heat of the current will be sufficient to melt

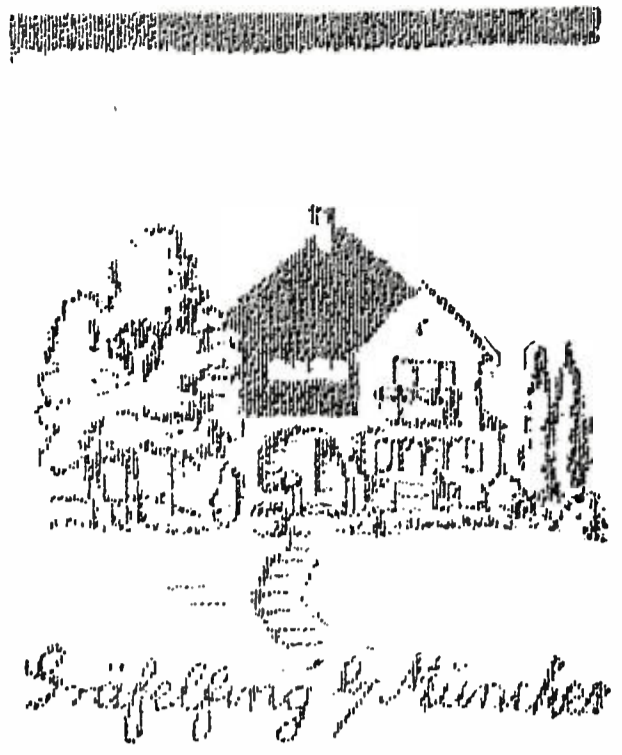

Rough Sketch Sent by Radio. Note the details Which are Visible. All These Pictures are Here Shown Full Size.

the color at the point pierced by the spark and to reduce it to a liquid condition. The recording surface at that point is thus covered with an adherent color solidified immediately as the spark ceases. Some brands of carbon paper, such as used in typewriting, are quite suitable, both the carbon and recording sheet being chosen as thin as possible.

A comprehensive set of tests was made between ground stations as well as between aeroplane and ground stations. Each original sheet was 13x18 cm² in area, of which about 13x15, i.e., about 200 cm², corresponded to the picture proper. With screws having an 0.8 mm. thread, the width of the picture comprised about 180 strokes, while in the case of a satisfactory adjustment the length of the shortest marks likewise was about 0.8 mm. The available picture area thus could be covered with 160x180=28,800 picture elements. About five to six minutes were required to cover the whole picture sheet, 80 picture elements being produced in less than a second and 4,800 in a minute. This limit should be warranted in order to insure reliable working of the electro-magnetical relays.

Some of our pictures were taken during tests made in October, 1918, i.e., immediately before the end of the war. The method, in this connection, was found fully suitable for the transmission of topographic sketches, reports, etc., from aeroplanes to the ground.

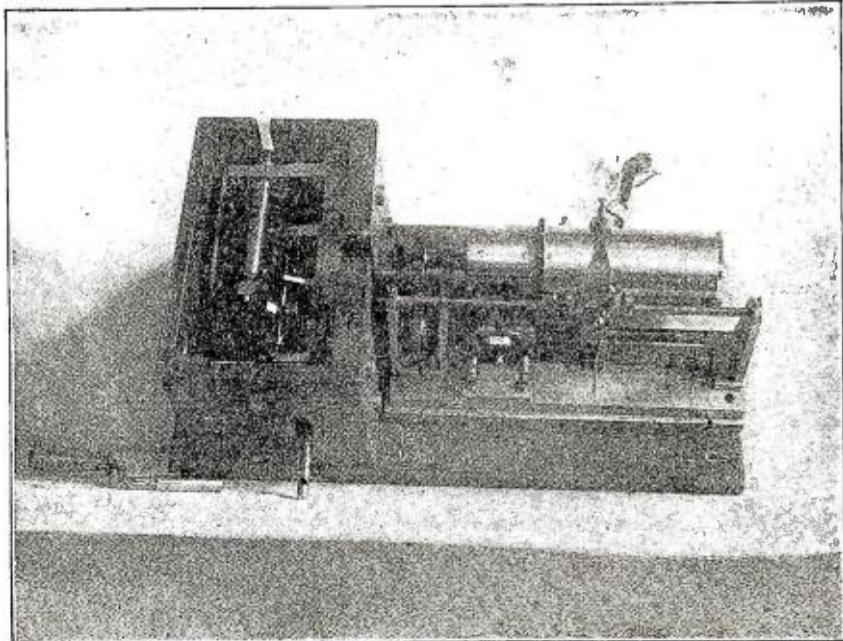

Two Views of the Cylinder Bearing the Picture with the Synchronizing System. On the right it is Shown Installed in an Airplane.

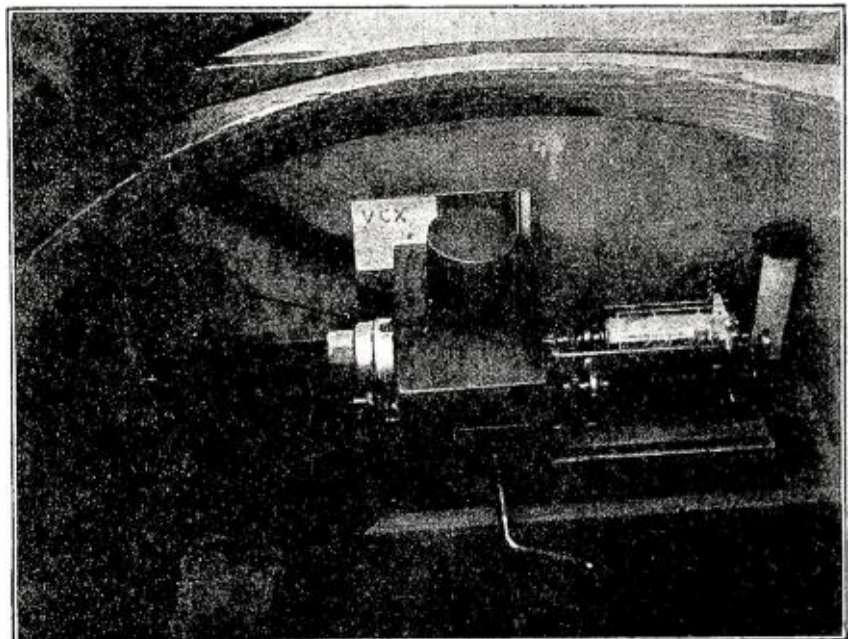

New Radio Apparatus

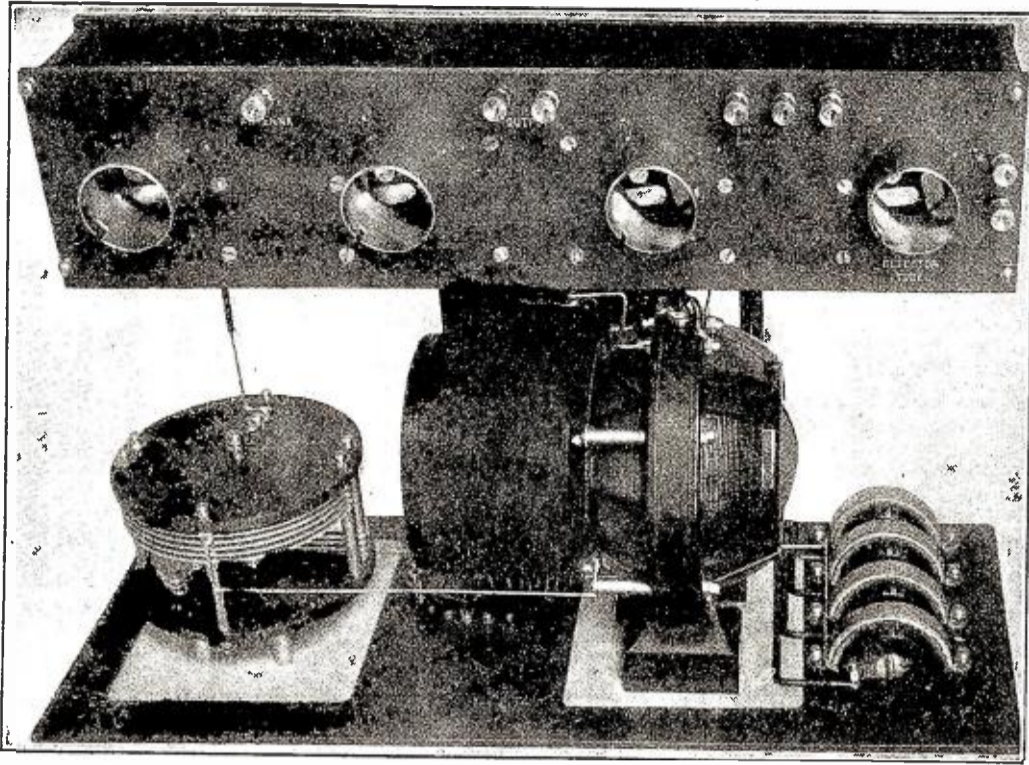

A Compact and Self-Contained Receiving Cabinet Having the Shape and Appearance of a Phonograph. Below the Set Are the Loud-Speaker Horn and the Batteries Compartment. On the Left Is a Top View of the Receiver Amplifier Removed from the Cabinet.

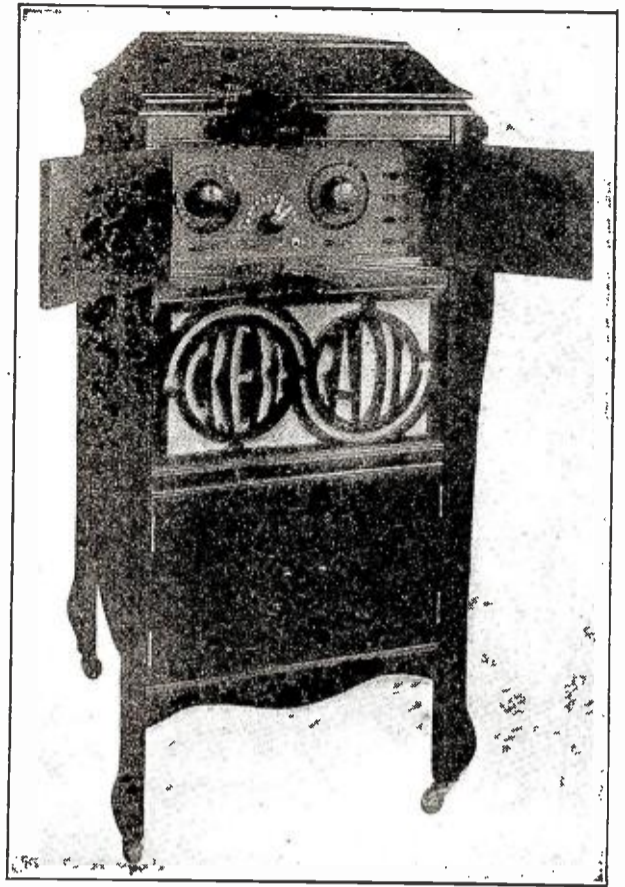

PHONOGRAPH TYPE RECEIVER

DURING the last few months radio receivers of various types have been on the market, which have been incorporated in a phonograph cabinet so that the complete instrument may be placed in a parlor without marring the appearance of the room. Few, however, have been designed for the purpose, and they consist merely of standard tuners and amplifiers mounted inside of little cabinets.

Some manufacturers have developed an apparatus which is especially designed to fit into a cabinet in which is incorporated a horn made of special wood having very good acoustic properties and fitted with a space for the necessary batteries.

One of this new type of phonograph receivers is shown in the pictures above. One of the pictures shows the inside of the tuner amplifier, which can receive any wave length up to 3,000 meters. Everything is incorporated inside this attractive piece of furniture and only the aerial and ground wires are to be attached to the set to put it in working order.

A NEW VERNIER RHEOSTAT

The photograph in the middle of the page shows a new type of rheostat which is a departure from the common design.

These new rheostats are built along entirely new lines and incorporate many novel features. A "full off" position is provided, eliminating the necessity of additional switches in the "A" battery circuit. A "full on" position is also provided which makes total battery potential available, rendering charging unnecessary until its full voltage has dropped below tube requirements. A nicked pointer indicates at all times the amount of resistance in the circuit.

The spring contact fingers are adjustable, and are so mounted as to lie in the direc-

tion of travel of the resistor, insuring smooth, quiet and positive regulation. The large number of turns of low resistance, each cut out or in, one at a time, provides fine gradation of control, minimizing clicking in the receivers during filament adjustment.

The rheostats are designed for panel mounting and are readily adjustable for

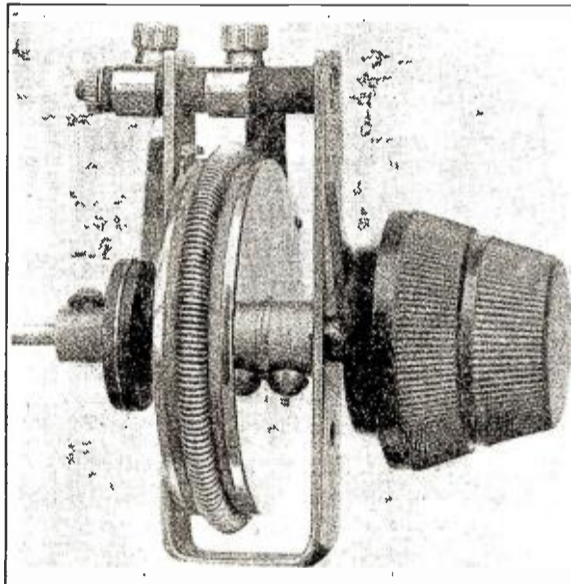

A Novel Vernier Rheostat Permitting a Very Fine Adjustment of the Filament Current of a Vacuum Tube.

panels ranging from one-eighth to one-half inch in thickness. They are designed to carry one ampere and have an operating range of from zero to four ohms. Two

amperes may, however, be carried in an emergency.

THE MICRODION

Here is a French novelty which has just been placed on the market over there. This little set, which is extremely compact, is of the regenerative type and the weight and size of it make it a really practical receiver which may be carried anywhere in a small bag.

The regenerative effect is obtained by means of a special iron core which may be introduced more or less inside of a specially designed inductance, acting as tickler. This iron core is controlled by the knob protruding through the side of the cabinet, upon which are mounted two switches and two variable condensers, as well as the vacuum tube sockets and binding posts for antenna, ground and phones. With this small receiver a special vacuum tube taking only .13 ampere is used. This is furnished with special dry batteries for the filament and plate current.

If desired, one or two stages of amplification may be added to the set and by the use of low consumption vacuum tubes, a small dry battery is only necessary for the filaments of all the tubes. One of the phonographs below shows the receiver to which is connected a one-stage audio frequency amplifier, enclosed in a small box connected on the right; the batteries being enclosed in the

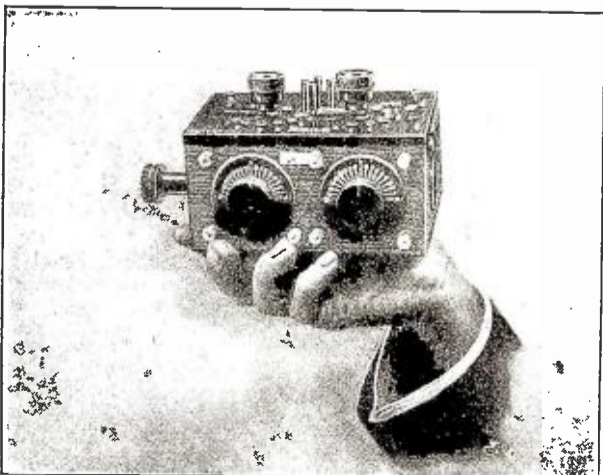

This Ultra Compact Regenerative Receiver of French Make May Be Carried Everywhere, as It Weighs Only Seven Pounds, Including the Batteries, Which Are of the Dry Type. The Vacuum Tubes Are Especially Designed, and Consume only 0.13 Ampere for the Filament. On the Right the Picture Shows the Set with a One-Stage Amplifier Connected to It.

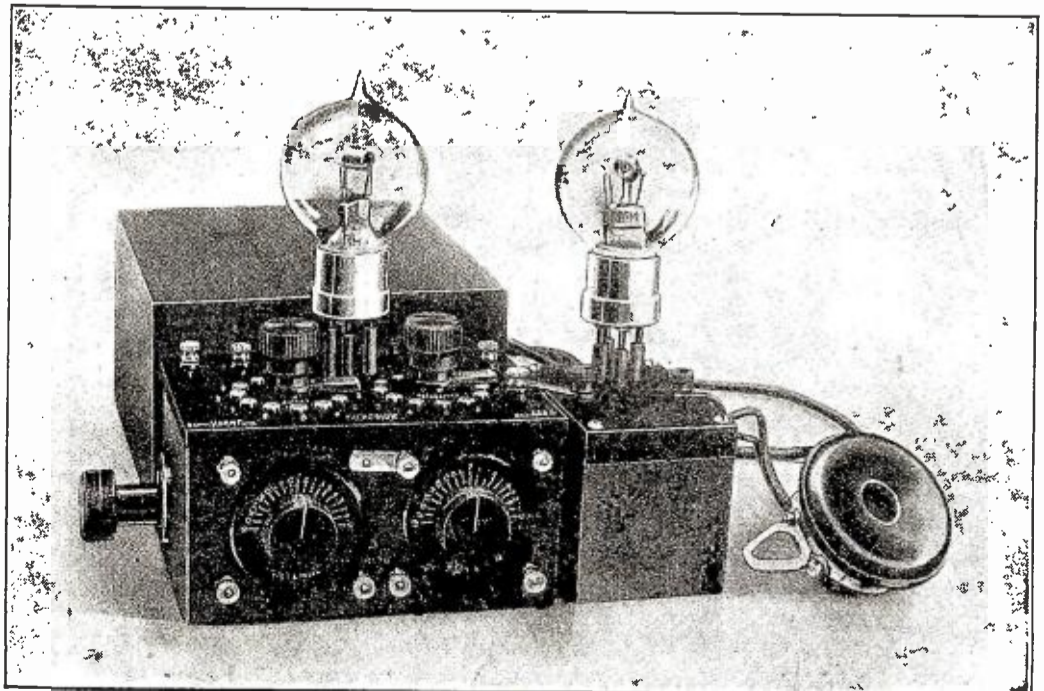



Another French Novelty, the Radio Table. It Is a Large Loop Aerial Combined with a Table and Cabinet for the Apparatus. When Closed, It Looks Like a Little Bookcase on a Table.

make the rotation of the table easy, if it is desired to turn the loop in different directions for the reception of various stations.

The winding of the loop is covered by thin panels of the same wood as the table; taps are taken on the wiring so that any number of turns may be connected to the set for the reception of different wave lengths.

A NEW LOUD-SPEAKER

The loud-speaker of the reflector type illustrated in one of the pictures is made of cast aluminum and is said to have remarkable acoustic properties. The head-set may be adapted for this apparatus by simply adjusting it on the two rubber tubes

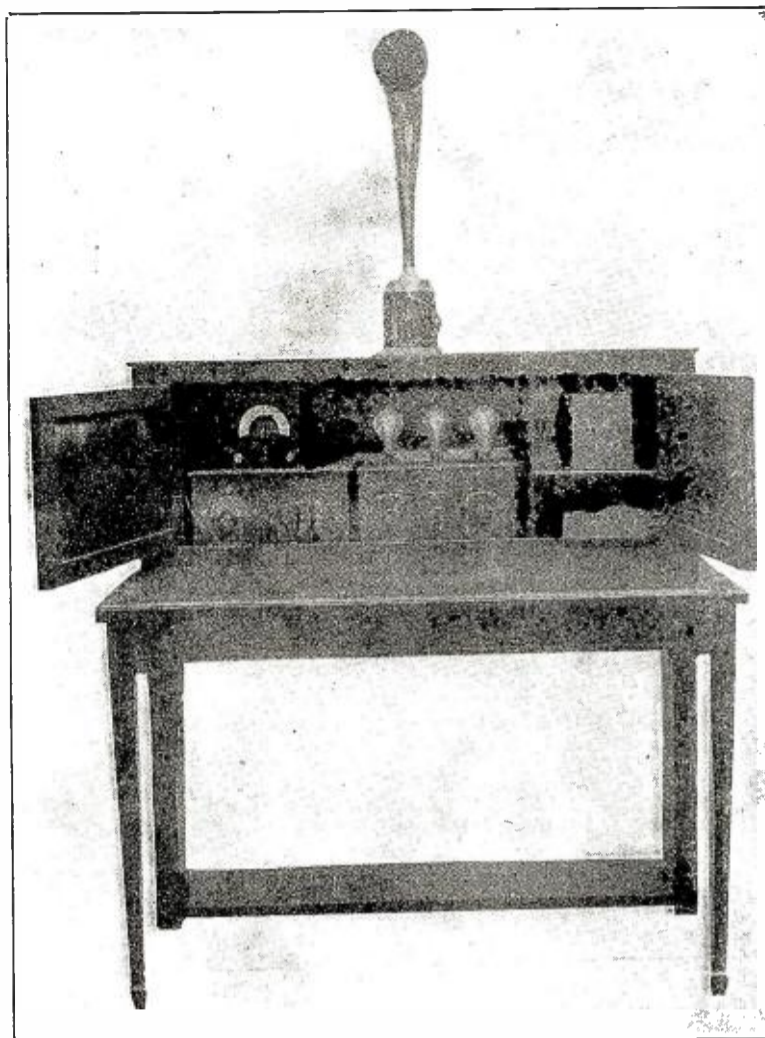

The Radio Table in Operation. Note the Battery Compartment on the Right.

little bag behind the receiver and amplifier.

Such an outfit, including the batteries weighs only 9 pounds.

THE RADIO TABLE

Another French invention which seems to have made a hit over there is a combination loop aerial, which is shown in two of the pictures, illustrating how the instrument looks when closed and open. This nice-looking "radio table" is supported on one side by the loop aerial itself, which is of rather large size and constitutes at the same time the top and sides of the cabinet in which the receiving apparatus may be installed. Under the feet special bearings

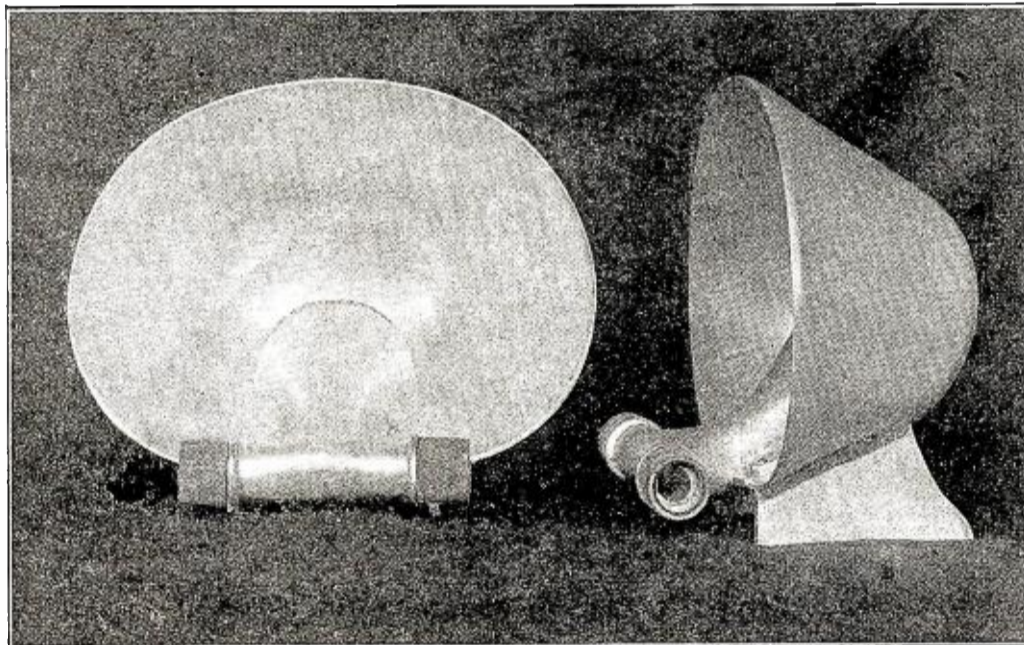

This Loud Talker of Cast Aluminum Is Said to Have Good Acoustic Properties. A Pair of Phones May Be Adapted to It without Removing Them from the Head-Set.

mounted at the extremities of a "T" shaped horn, projecting the sound inside of the bowl-shaped reflector, which in turn throws it out into the room.

The apparatus being cast in one piece of the proper thickness does not vibrate, and reproduces the speech and music with their true tones. For best results, an amplifier which does not distort the sound must be used, as in most cases distortion occurs when too much amplification is used to boost up the signals. The telephone receivers must also be able to reproduce clearly the speech and music with enough volume.

German Radio Press Receiver
By MAURICE E. PELGRIMS

THE German Telefunken Company, meeting the growing demand for radio apparatus emanating from persons or firms who wish to obtain radio press reports, stock market reports, etc., but who as a rule are but slightly acquainted with radio technicalities, recently placed a complete and up-to-date type of long-wave receiver on the

market, especially designed for this type of customer. The set may be fitted to the wall, as shown in the illustration, leaving the desk entirely free. The complete set consists of a main receiver, shown in center of illustration, having a fixed inductance, one variable condenser, one detector and one amplifying bulb and telephone head-set. This part of the set provides for a wave range of from 3,000 to 4,500 meters. The names of the stations are printed on the dial of the condenser and the person receiving has but to set the instrument near to this indication in order to obtain the station desired. Of course, a little additional adjusting may be required to bring in the station louder. On the left is seen the resistance box which controls the voltage to filaments and plates of the receiving valves. This box is connected directly to the mains. An additional two-step amplifier may be connected to the receiver if greater amplification is desired.

The set, as stated above, is especially designed for use in banks, business offices, newspaper offices, etc., and has gained still greater favor since the advent of wireless telephone stations are broadcasting stocks and press items. Privately it is used for receiving wireless telephone concerts.

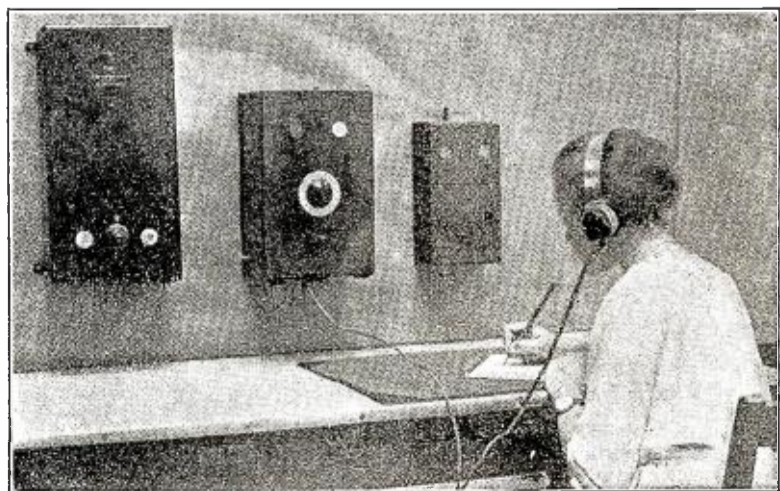

This German Receiver, Entirely Fool-Proof, Has Been Designed for Use in Banks, Newspaper Offices, Etc., Where No Skilled Operators Are in Charge.



In Germany, This Time Signal Receiver, Which May Be Hung on the Wall, and Is Tuned on a Fixed Wave-Length, Is Sold for Use by Jewelers and Inexperienced Persons.

Transmission of Photographs By Radio

By ARTHUR BENINGTON

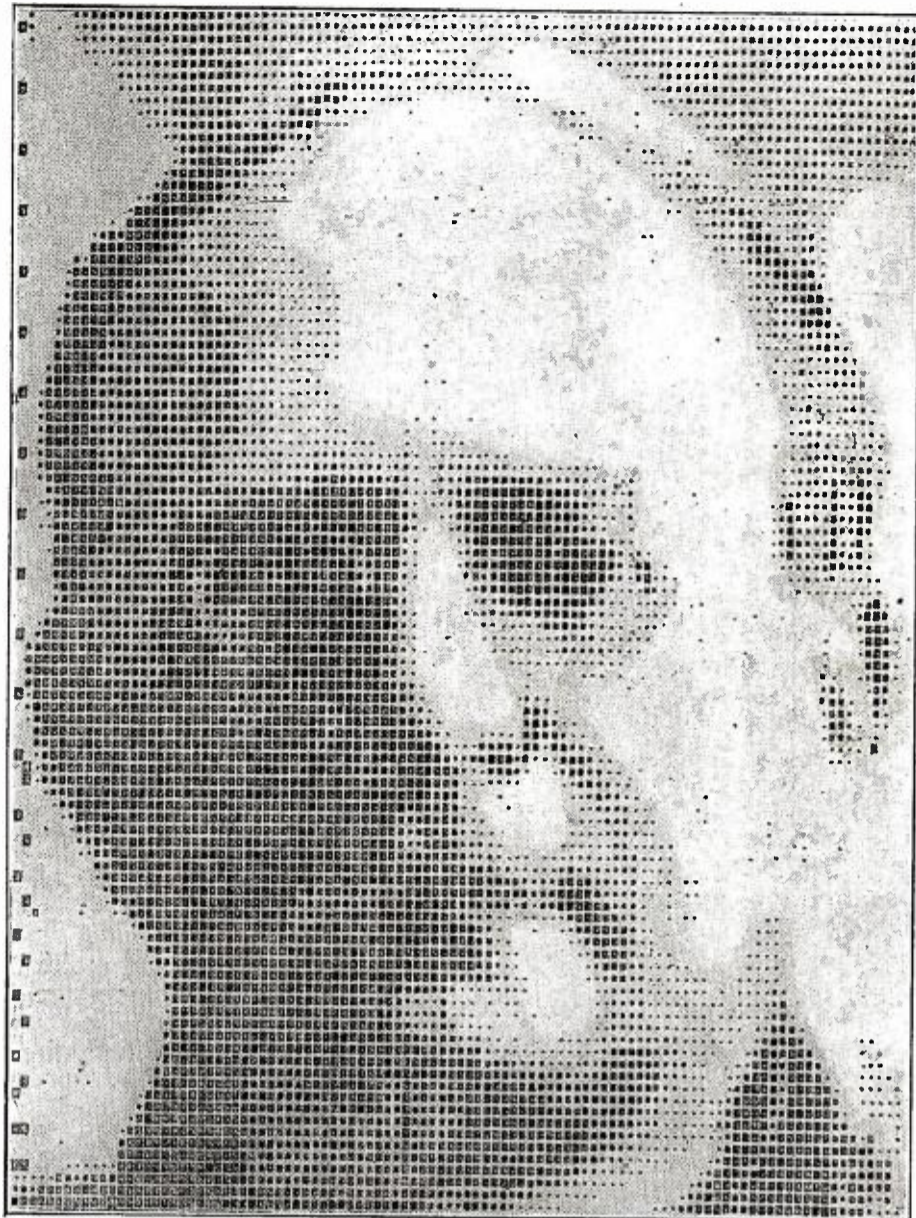

This Picture Was Sent From Italy to America by the Process Described in This Article. The Original is About Double This Size.

THE actual reception of a photograph by radio from across the Atlantic marks an epoch in the history of rapid communications. The first step in that history was the transmission of word messages by telegraph; the next was the transmission of human voices by telephone; the third was the transmission of messages without wires, with the air as the only medium; the fourth was the wireless telephone, and now it is the wireless photograph.

The art of sending and receiving photographs in a few minutes from a great distance is just born. The pictures, although as yet far from perfect, are already well adapted to the use of a daily newspaper, and with certain simplifications of the apparatus and the use of fine adjustments, both of which will easily be brought about, the picture will be good enough for use, without retouching, by the highest class of magazines.

It is to the enterprise of the New York World that we owe the introduction of this latest invention to America; it was the same paper that introduced us two years ago to the process of sending a photograph a thousand miles over a land wire. The latter was the invention of Ferdinand Eduard Belin, the former is that of the German Albert Korn. Korn's process, though then far from perfect, had already received a little publicity before the war; he had not yet thought of sending photographs by radio, for radio was still in its infancy, but he had patented the process in all the principal countries of the world and had succeeded in transmitting a few crude pictures by wire from one point to another in Germany. The coming of the war suspended further

and portable by hand, the senders were, and are still, heavy and cumbersome, being built solely for laboratory experiments and without an idea of portability. Preliminary tests between Rome and Berlin were so perfectly successful that a few months ago he invited the King and Queen of Italy and many officers of the Army and Navy Communication Service to witness an official test. This consisted in taking a photograph of King Victor Emanuel and transmitting it to Berlin by radio from the Italian Naval radio station at San Paolo, near Rome. How successful this was may be gathered from the fact that the photograph was printed in a Berlin newspaper and the edition containing it was actually on sale in the streets of that city just one hour after the operator at San Paolo placed it on the machine.

The naval officers present were so impressed by the value of the new process

experiments and kept the inventor busy at his post as Professor of Electro Physics in the Berlin High School of Technology.

When the war was over, wireless telegraphy had progressed to such an extent that Prof. Korn desired to resume his experiments and to perfect his apparatus for use by the new method. But in Germany he could find no money which would pay the expenses of bringing the machines to perfection. Korn went to Italy, the birthplace of radio, and had little difficulty in finding Italian capitalists who would back him. He established a laboratory at Centocelle, near Rome, where he completed his apparatus, and he transferred all his patents to a company organized by Francesco Pascale, a Roman Senator. Korn built two sets of apparatus, one at Centocelle and the other at Berlin. The receivers were simple

that they arranged with Prof. Korn to make some more tests between San Paolo and warships cruising in the Mediterranean. As a result of these the Italian Ministry of Marine bought the receiving apparatus which its officers had been using. On the urgent solicitation of the American Naval Attaché in Rome, the Ministry of Marine lent this instrument to the American Navy. Chief Radioman Edmund H. Hansen had been sent by the Secretary of the Navy to Europe to study methods of transmission of photographs by radio and he had been permitted to witness some of the tests. It was largely on his recommendation that the machine was brought to America a few months ago and installed at the Naval Radio Station at Otter Cliffs, near Bar Harbor, Me., where official tests have been going on for several weeks. These ended in the first week in June and the official report on them has not been made public at the present writing.

The method invented by Korn is based upon the principle of reducing the infinite number of values of light between absolute white and dead black as found upon a photograph into as small a number as may be necessary to reproduce approximately the values of the pictures and to assign to each value a corresponding letter. Korn found that from fifteen to twenty values were ample and he adopted eighteen, although by practice he has learned that twelve values suffice.

An ordinary newspaper half-tone is made up of a multitude of tiny dots, very small in the lighter shades, large for the darker. These are produced by photographing the picture through a fine wire screen. Korn obtains a similar effect by mounting a negative on a transparent cylinder upon which a bright light is concentrated to a point by a lens. The cylinder turns upon its axis, its speed being regulated by a commutator which stops it for an instant at absolutely accurate rhythmic intervals, in such a way that the point of light traveling across it passes through it at each of these intervals. The lighter the negative the more light passes through it, the darker the less.

Inside the transparent cylinder is a selenium cell, through which a very small current of electricity passes. Everyone knows—or should know—that the resistance of selenium to the passage of an electric current varies with the brightness of the light that reaches it. Therefore, the intensity of the current that passes through the cell is regulated by the intensity of the ray that reaches it through the negative. Korn succeeds in this where other experimenters have failed, for the reason that he does not try to make the current which passes through the selenium carry the varying value of the photo-

(Continued on page 369)

Sample of a Message Which, When Translated Through the Special Typewriter, Reproduces the Picture.

O0AQM XLLLL LLLLL LLLLL FIFTH LLLLL LXMJJ JJJJJ JJJJJ JJJJJ
JJJJJ OVOOA MXLLL LLLLL SIXTH LLLLL XMVJJ JJJJJ JJJJJ JJJJJ
JGGOV VVVVV VOVAX LLLLL LLLLL SEVENTH LLLLX XJJJJ JJJJJ JJJJJ
JJJJJ JGGOV VVVVV VVAAA XRLL LLLLL EIGHTH LLLLX XJJJJ JJJJJ
JJJJJ JJJJJ JGGOV VVVVV VVAAA MXRLL LLLLL NINTH LLLLL JJJJJ
JJJJJ OOVVV VVVVV VVVVV VVVVV VOVAA AMAXR LLLLL TENTH LLLL O
JJJJJ GGGOO OGGGG OVVVV VVVVV VVVVV VAAMM MVMXX LLLLL ELEVENTH
LLOOJ JJJJJ JGGVV QQAAA QVVVV VVVVV VVVVV VVVVV VMMMXX RLLLL
TWELFTH LLLJJ JJOVV OVVVV VVVVV VOXMM MVVVV VVVVV VVVVV VVVVV
XRLL THIRTEENTH LGGJJ JOAAA AAAAA VOQQM VOQQM XXMAV VVVVV VVVVV
VVVVV XRLL

Marconi Presented With Radio Institute Medal of Honor

Demonstrates New Device for Uni-Directional Transmission

GUGLIELMO MARCONI, the man who first developed radio telegraphy, delivered an address on June 20 before the largest crowd that has ever gained admittance to the auditorium of the Engineering Societies Building in New York. He astonished everybody by describing his experiments with reflectors for uni-directional transmission of radio waves. The instrument which he described demonstrated the possibility of radio light-houses, equipped with reflectors which would revolve and transmit radio waves in much the same manner as a beam of light is at present radiated. By this means ships would be informed of their positions without relying upon the light-houses, which are invisible in a fog.

On the stage from which he spoke Mr. Marconi had erected a model of the reflector. The general design of this reflector is shown in the photograph on the right. A short distance away a receiver represented the ship station. Mr. Marconi demonstrated that it was necessary that the reflector be turned in the direction of the receiver for the signals to be received. When the reflector was revolved in such a way that it did not point towards the receiver no sound was heard from the latter.

Mr. Marconi reminded his audience of his earliest experiments in radio communication, at which time he had experimented with radio waves a few inches in length. Since that time most of the experiments have been conducted with much longer wave lengths, ranging up to 25,000 meters. However, since it is possible to reflect wireless waves much in the same manner as it is possible to reflect light, Mr. Marconi has been returning to the shorter wave lengths. By this method of reflection the energy is concentrated in one direction, instead of being radiated in all directions, as in the case of the ordinary transmitter. He found that static interference practically did not exist on the very short wave lengths, although interference

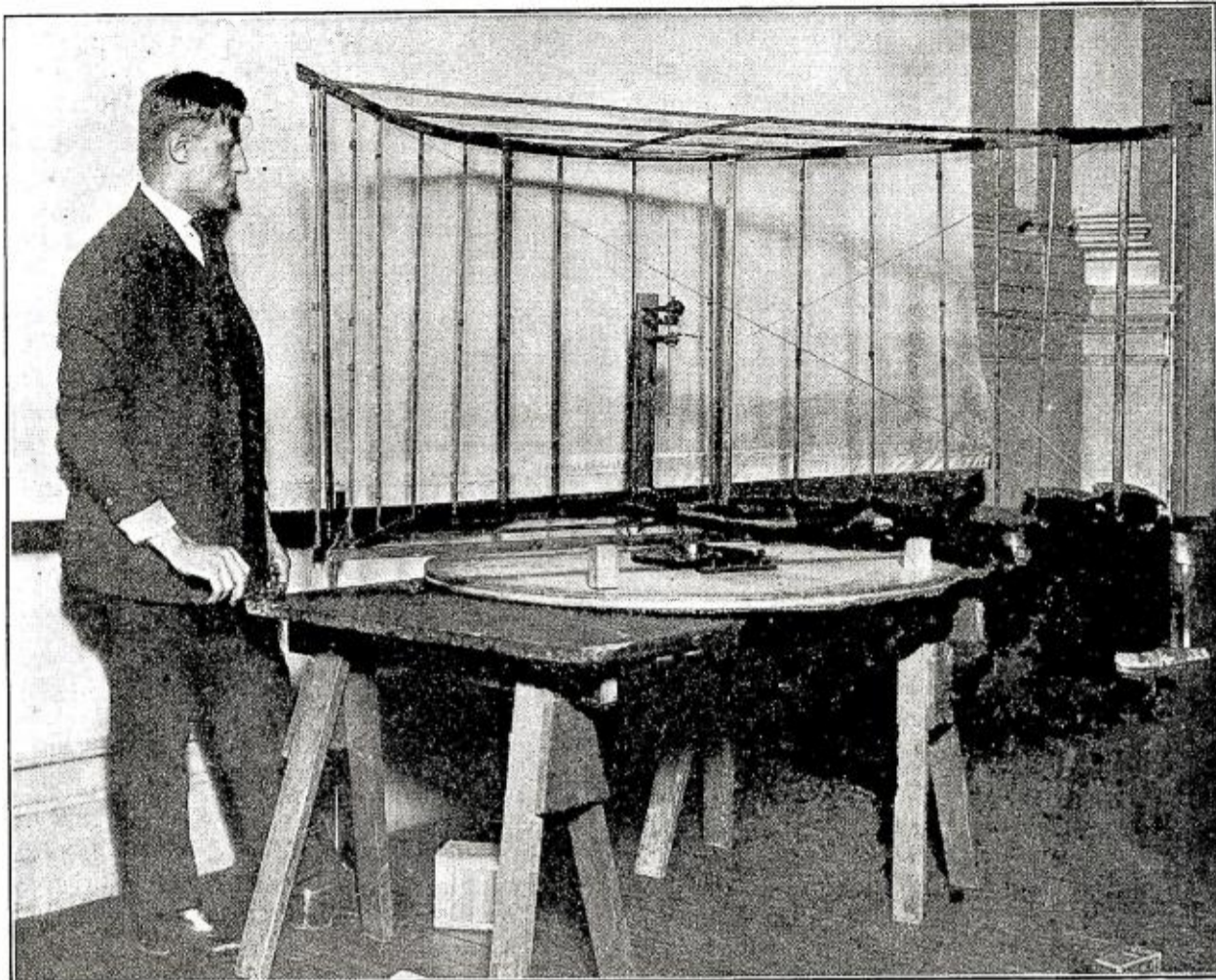

This Screen, Used in the Demonstration of Uni-Directional Transmission, May be Rotated, and the Waves Sent in a Particular Direction in the Same Way as a Beam of Light is Thrown From a Searchlight.

was caused by the ignition apparatus of automobiles and motor-boats. The wave length it is possible to use by this reflection method is, in any case, limited, as the dimensions of the reflector would be increased in proportion to the increase of wave length.

In 1916 Mr. Marconi conducted experiments in Italy in which waves of two and three meters were employed. The reflector was made of a number of strips of wires tuned to the wave and arranged in a cylindrical form. The transmitting system was revolved. These experiments showed that good directional work could be obtained with reflectors of the proper proportions and respective wave lengths. Later on, in England, tests on the same wave length demonstrated the fact that much better results could be obtained when the transmitter and receiver were elevated from the surface of the ground. With a transmitter at a height of 600' and a receiver 300' from the ground, with a clear air line between, a distance of 20 miles was covered with a 3-meter wave length. At sea level it was only possible to transmit a distance of four miles. When both transmitter and receiver were at low level, the distance it was possible to transmit seemed to depend greatly upon the nature of the intervening country. In 1919 further ex-

periments were made in England, in which a wave of 15 meters was used and a single vacuum tube transmitter. In place of the crystal receiver of previous experiments, a vacuum tube receiver with external heterodyne was employed. The same type of reflector was again used and strong speech was easily obtained at a distance of 20 miles. Later, on the same wave length of 15 meters, speech was exchanged at a distance of 100 miles between London and Birmingham. This was a record for long distance transmission and reception of short waves.

At the conclusion of his address Mr. Marconi was presented with the gold medal of honor of the Institute of Radio Engineers. The meeting was held under the joint auspices of that society and the Society of Electrical Engineers. In his appreciation Mr. Marconi declared his belief that America led the world in radio communication.

The meeting was attended by nearly 1,100 people and hundreds of others eager to see the great inventor and hear his address were disappointed and turned away from the doors.

Mr. Marconi has not made any definite plans for his visit to this country. He left New York and sailed up the Hudson on the *Electra* on his way to Schenectady. On this cruise Mr. Marconi staged a radio dance to entertain his guests. Dance music was furnished by one of the broadcasting stations, and on the deck of the *Electra* a loud-speaker took the place of an orchestra.

At Schenectady Mr. Marconi met Dr. Lenz and Dr. Steinmetz and expressed considerable interest in the 50-kilowatt tube shown to him. In the evening the radio audience was entertained by an address delivered by Mr. Marconi from the Schenectady broadcasting station of the General Electric Company.

Editor's Note.—It is expected in a future issue of RADIO NEWS to give further details concerning experiments in directional transmission conducted in England by Mr. Marconi.

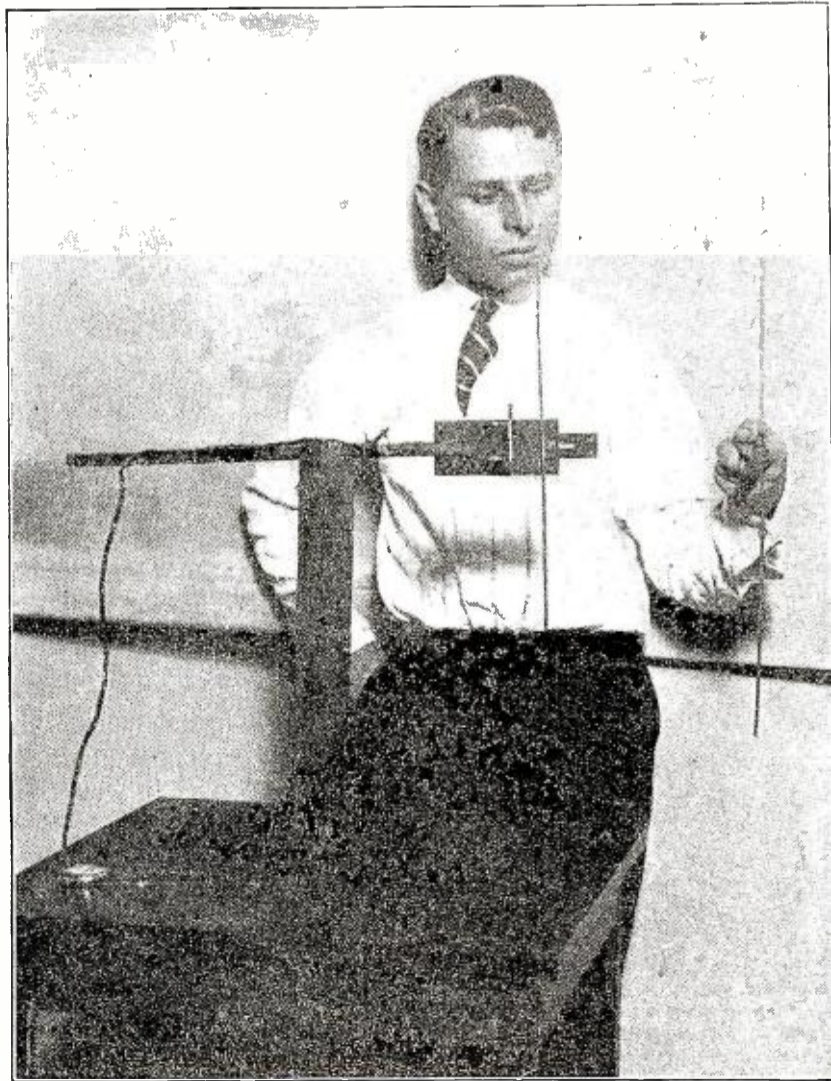

The Special Apparatus Used for the Reception of Very Short Waves.

Advertising by Radio, Can It and Should It Be Done?

By J. C. McQUISTON*



Advertising by Radio Cannot Be Done; It Would Ruin the Radio Business, for Nobody Would Stand for It. Mr. McQuiston in this Article, Explains Why.

THE full possibilities of the radiophone are not yet known. The popular reception given to it during the past year has been sufficient to stir the whole of our population. Radio now takes the place of both the weather and health as the chief subject of conversation. It is no wonder that just as soon as the public recognized the use of radio, advertisers gave consideration to this wonderful agency for spreading selling information. The experience that has been gained in the short time that the radiophone has been rendering service to the general public may even now give us a

*Manager, Dept. of Publicity, Westinghouse Co.

fair idea of some important limitations to this wonderful medium.

Whatever statements, however, that are now made are based wholly upon the possibilities of the present development of radio sending and receiving apparatus. Of course, what may follow no one can tell, but even with the present limitations the radiophone, as a means of broadcasting from a central point to great distances, will prove a wonderful benefit to mankind.

By way of preface, I wish to say that radio broadcasting will not, in my opinion, supplant, or interfere with newspapers as a

medium of disseminating news, nor with concerts, churches, theatres or movies, as entertainment features.

On the contrary, it has been proved that the broadcasting of news bulletins by radio, and the publication of radio programs have increased materially the circulation of newspapers. I will risk the statement that since radio broadcasting was begun, the total circulation of all newspapers has been considerably enlarged, and I believe the publishing of radio broadcasting programs and other features pertaining to radio by the newspapers have been responsible in a very large measure for this increase.

Churches that have broadcasted their services have actually found that the attendance of services has increased rather than diminished; and although it is true that some few members of the church may prefer to hear the services while lying in bed, there are hundreds who never go to church and who, hearing the appeal of the pastors, are not satisfied to receive all their sermons by radio, but will respond to that natural desire to hear direct, and to see the speaker.

The same thing is true with reference to amusements. Certain amusement houses have had connection with our radio service for over a year and they are very glad, indeed, to continue the service because the hearing of artists by radio simply intensifies the desire to actually be present in the theater to witness the performance.

(Continued on page 332)

Radio to Supplant Universities?

By LUCIAN JENNESS

LABORIOUSLY the lump of bed clothes untangles and a sleepy-eyed student emerges from his night's snooze. Yawning and grunting like a pig in a mud hole, he finally clutches at a pair of radio phones and adjusts them on his ears. Then he puffs his pillows and sits up. Reaching for a notebook and pencil on a nearby chair, he grumbles:

"Oh Lord, what a tough old world. These confounded early classes get my goat. The idea of waking a guy at this hour of the day. AAAAAH-phump!"

Then he starts taking notes in a book as they come by radio.

Such is the manner in which the future University student will do his work. No longer is it going to be necessary to bolt a breakfast, madly catch a car, race to class, flop

into an overheated room, and listen to a dry discourse on the reaction of protozoa to the stimulus of tantamount quantities of amalgamated sufflex—or words to that effect.

Instead, the future pursuer of knowledge will tune in on a radio concert of an all-night party that has not broken up at this time.

Reports from Universities throughout the country show this situation to be no wildcat dream but an actual fact today. Tufts College in Massachusetts is broadcasting twice a week to more than 35,000 persons, scattered from Wisconsin to Florida. Its gigantic wireless towers at Bedford constitute a real radio college. Officials of that institution have organized a special faculty to give a course of lectures by the air.

Not only in the East, but in the West, schools are busily engaged in wireless broadcasting. Wisconsin has achieved the first "wireless newspaper" (Continued on page 334)



Attending the University Courses by Radio. How Would You Like That Boys? Guess the Battery Would Often Run Down.

Who's Who in Radio

LOUIS COHEN, Ph. D.

No.18

DOCTOR LOUIS COHEN was born in 1876 and educated at Armour Institute of Technology, the University of Chicago, and Columbia University. From 1905 to 1909 he was attached to the Scientific Staff of the Bureau of Standards, Washington, and from then until 1912 he was Chief of the Research Department of the National Electric Signaling Co. Since 1912, Dr. Cohen has been engaged in research and consulting practice. In 1920 he was appointed Consulting Engineer of the Signal Corps and has acted as Professor of the George Washington University since 1917. Last year, Dr. Cohen was appointed delegate on the Advisory Technical Board to the Conference on Limitation of Armament.

Dr. Cohen has specialized in the theory of electrical oscillations and their application to telephony, cable telegraphy and radio. He published a series of papers on inductances giving for the first time suitable and accurate formulae on the calculation of inductances for different types of coils. He has also published many papers on various phases of radio and related subjects. In 1913, Dr. Cohen published the well-known reference book "Formulae and Tables for



DR. LOUIS COHEN

the Calculation of Alternating Current Problems."

Dr. Cohen gave considerable attention to long distance transmission problems and introduced jointly with Dr. Austin the Austin-Cohen transmission formula. The first investigation of the important subject of the theory and method of heterodyne reception was made by Dr. Cohen in 1910. He was the inventor of the electro-statically coupled receiver, the absorption circuit relay for arc signaling and many other devices and improvements in radio signaling. He has given a great deal of attention to problems relating to reception of radio signals, and is at present developing a radically new method of receiving radio signals which renders reception entirely free from interference and static disturbances.

The method employs a resonance wave coil for reception.

This coil, which consists of a long tube closely wound with wire, takes the place of the antenna; no ground is required. According to Dr. Cohen, the method consists of receiving the radio signal and passing it through the resonance wave coil which drains off the interfering disturbances.

\$375.00 Pocket Radiophone Prize Contest (RADIO NEWS' Sixth Prize Contest)

WE present a new \$375 prize contest to our readers, entitled

POCKET RADIOPHONE PRIZE CONTEST

We wish to say right here, in order not to mislead our Radio experts, that we are using the word "Radiophone" advisedly. In popular parlance, a radiophone outfit these days means anything that can receive broadcast entertainment. In reality, and in technical language, a radiophone is an outfit which transmits radio telephony.

This contest has to do with a radio receiving set small enough to be placed in the pocket. At the present time, particularly, there is a lively interest being displayed for such outfits not only for vacation purposes, but for automobile work, motor boats, hiking trips, for the home, etc. The time is drawing near when the big, bulky outfit will be a thing of the past.

RADIO NEWS has always wished to advance the Radio art as much as possible and always tries to encourage new developments in the various Radio phases. Hence this prize contest.

As will be remembered, we ran a contest similar to this one in 1920, which was our third contest entitled "\$100 Portable Radio Prize Contest." This contest differs from the former in that we restrict the size of the outfit so that it becomes a true pocket outfit. Remember that the Editors are not looking for freaks. The outfit must work and in order to prove it, it is necessary that the contestant must build it, as no entries can be considered unless each is accompanied by photograph, or the actual outfit.

This contest will give our Radio enthusiasts a chance to show their ingenuity. When we say pocket outfit, we mean just that. As long as the outfit can be slipped into an ordinary coat pocket, it is eligible. If it can be made smaller, as for instance, to fit into a watch case, or still smaller for that matter, the Editors will have no objection to this, as long as the outfit works.

It makes no difference what style of detector is used; it may be a crystal set, or it may be a vacuum tube set.

AERIAL: A pocket Radio set naturally cannot be used with a bulky aerial. If you go on an automobile trip, or go camping, the outfit must be able to bring in the radio entertainment without the addition of bulky poles, spreaders, and the like. We all know that a single wire anywhere from 60' to 100', is, as a rule, sufficient to bring in the broadcast entertainment reasonably clear. We, therefore, need besides the outfit, an antenna outfit, and this also must be small enough to fit into the pocket. That means, of course, that we must

have a separate box or container to house the aerial wire, insulators, and other necessary paraphernalia. Of course, if the constructor can encompass the entire radio outfit, instruments and all, plus aerial in a single box or container, so much the better.

On the other hand, it would be almost impossible to build a vacuum tube set and fit it into the dimensions which we give below, and which must be surpassed. Such an outfit needs batteries, and it would, therefore, be allowable to have two separate boxes or containers, one to contain the Radio instruments with its tubes, while the other would contain sufficient batteries, aerial wire, etc. We appreciate that we do not allow much room for the batteries, but there are tubes made at the present time which may work without "B" batteries, using only the voltage drop from the "A" battery, which may consist of four dry cells to a voltage of 6, or thereabouts.

PRIZES \$375.00 IN GOLD

First Prize	-	\$150.00
Second Prize		100.00
Third Prize	-	75.00
Fourth Prize	-	50.00
TOTAL		- \$375.00

In publishing the various ideas, all the rights revert to the publishers, the latter also reserve themselves the rights to publish all manuscripts sent in to this contest, although not prize winners; in that case full space rates will be allowed.

As will be noticed, the publishers offer prizes totaling \$375 on the best idea for the most practical and efficient radiophone receiving outfit that will fit in the average coat pocket. Several radio experts will act as judges, and all judges will pass upon the manuscripts submitted so that all contestants will be treated fairly and impartially.

From the very nature of this contest, we are quite certain that it will not only bring out the very best there is in the American radio amateur but that it will advance the art for small radio receiving outfits considerably.

RULES FOR THE CONTEST

The receiving set to be eligible must be of the usual receiving type, vacuum tube or crystal detectors can be used at the option of the builder.

Some new constructional feature embodied in the outfit not used before will be necessary to win a prize.

It is necessary that the set has been actually built and must be either in use, or formerly used.

Mere ideas or patent descriptions, as well as commercial Radio outfits, are strictly excluded from this contest, which is only for individuals.

Where standard instruments, such as condensers, tubes, etc., are used, the make of such instruments must be stated.

A good diagram of the connections, well executed in ink, must be furnished.

A good photograph not smaller than 5"x7", giving at least two views of the outfit is necessary.

A photograph of the builder is also required.

The size of the outfit itself cannot be larger than 4" wide, by 6½" long by 2" high; these are the outside dimensions. It is allowable to have in addition to this, an extra container or box for the aerial, batteries, insulators, etc., but not more than two containers or boxes of this size are allowed.

Telephone receivers are not included, and can be separate, that is outside of these dimensions. It is, however, allowable for constructors to use a single telephone receiver and build this directly into the outfit so that the entire outfit can be held against the ear if such a construction is preferred.

All photographs, diagrams, and other data sent in by contestants, which are not used, will be returned at the publishers' expense.

Where the judges seem to have doubt as to the practicability of the instrument, they reserve the right to inspect and test the set. Insured parcel post charges for expressage at the publishers' expense both ways. Such instruments will be returned promptly to the builders.

It is better to submit the outfit with the entry wherever possible. More than one outfit may be entered by contestants. The contest is open to everyone, Radio Clubs included, except manufacturers of Radio apparatus.

Manuscripts must not be longer than 1,500 words.

All prizes will be paid upon publication.

THIS CONTEST CLOSING IN NEW YORK AUGUST 15, AND THE FIRST PRIZE-WINNING ARTICLE WILL APPEAR IN THE OCTOBER, 1922, ISSUE. ADDRESS ALL MANUSCRIPTS, PHOTOGRAPHS, ETC., TO EDITOR, POCKET RADIOPHONE CONTEST, CARE OF THIS PUBLICATION.

A. C. Rectification for C. W.

By E. T. JONES, A. I. R. E.

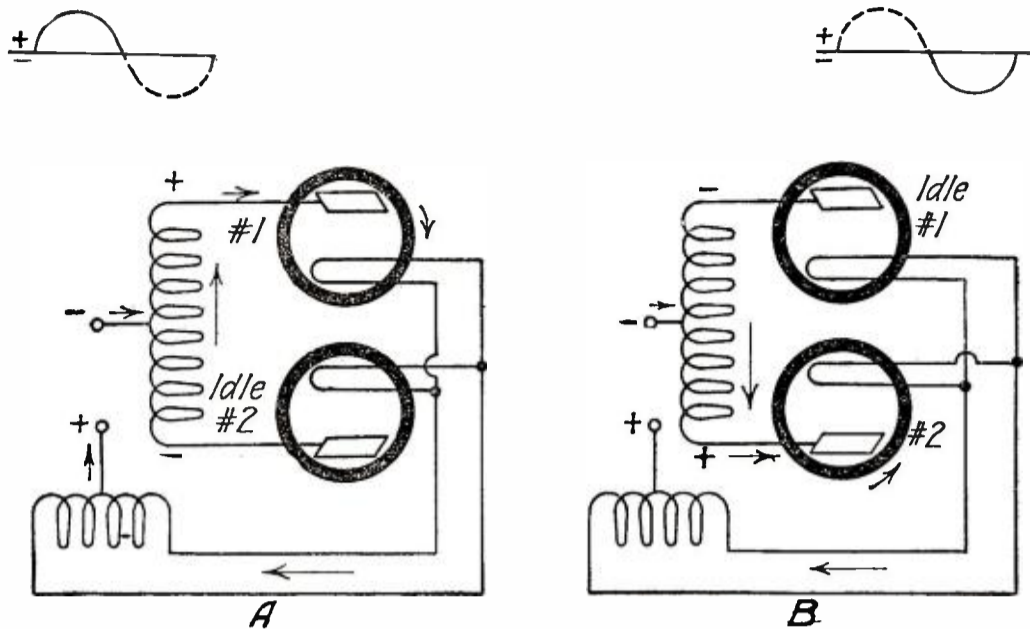

FIG. 1
C. RADIO NEWS 1922

These diagrams show how the alternating current is rectified through two Kenotron tubes.

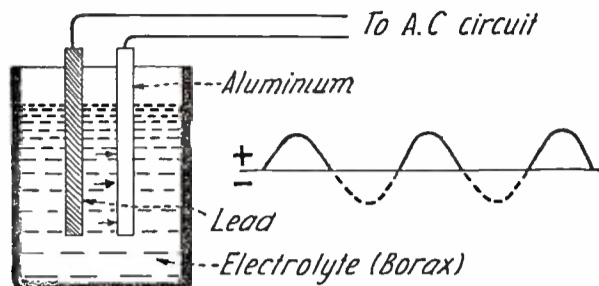

Fig 4

Showing the Action of an Electrolytic Rectifier. The Current Can Pass Only in One Direction.

the filament and other elements. The kenotron tube is especially designed for that purpose and the necessary spacing allowed. Besides, unless the experimenter has a good milliamperemeter at hand he cannot determine whether he is receiving enough current in milliamperes to operate the number of tubes in the oscillation circuit. If a good meter of this type is at hand, first determine whether the tubes are rectifying or not, and if they are delivering sufficient current for the oscillation circuit tubes.

With kenotron tubes there is no necessity of having a meter, but it is a very good plan to always have one in the circuit when operating with this critical "stuff." It will save many cuss words and headaches.

Fig. 3 gives the circuit of the transformer connected to the 110-volt A.C. 60 cycle mains; the high voltage side of the transformer connected to the plates of the rectifier tubes; the filaments of the rectifier tubes connected in parallel and thence to the filament 7.5 volt lighting winding on the transformer.

The filter circuit consists of two .01 condensers and two 1.5 m.h. inductance (iron core) units. These are easily procured from any company dealing in radio apparatus.

The high voltage direct current supply is now available at the terminals 1 and 2; they can be connected to any type of radiophone circuit for the high voltage supply.

ELECTROLYTIC RECTIFICATION

If we place a strip of lead and a strip of aluminum in a solution of borax (20 mule team) and connect an alternating current course to the terminals of the strips, the current will be rectified and only one half of the cycle will get through, see Fig. 4. The current can only pass from the lead to the aluminum plate. Therefore, when the positive side of the line is connected to the lead plate (which is every other half cycle) current will flow through the solution from the lead plate to the aluminum plate and back through the line. This principle of rectification is now being used to faithfully rectify the high voltage of the C.W. power transformer.

(Continued on page 338)

THE initial cost of the D.C. motor generator or converter is causing it to become less evident at C.W. radio experimental stations. Many an amateur has been able to obtain everything else but this one item, and if nothing had been done to permit the amateurs of this country to economically experiment with C.W., this new "bug" would have died an honest but fruitless one.

In every large city alternating power is used to furnish the residential district with power for lights, heaters, etc. The big proposition which confronted the average amateur was the conversion of this 110-volt A.C. current into direct current. This has been successfully brought about, and it is easily said that this type of converter is doing everything the motor-generator A.C. to D.C. machine was capable of doing.

So smoothly has the alternating current been converted to direct current, that no deflection is noticeable on a direct current galvanometer when the ordinary precautions are observed.

The A.C. rectifier or transformer is noiseless in operation and is much more economical in operation and overall efficiency. This transformer (the type described in my previous article) also furnished current for the filament of the rectifier or oscillator tubes or both.

The first type of rectifier to be described will be the kenotron rectifier, which is after all the most efficient. While the tubes are fairly high-priced ones, their life and services warrant that expenditure.

The kenotron rectifier works on the Edison principle, which was applied by Fleming to his valve used as a detector of feeble electrical oscillations. There are but two elements in the tube, the filament and plate.

Although we have been taught by the conventional flow of electrical current that the current flows from the filament to the plate, in this particular case this is proven to be just the opposite by the electronic theory.

In Fig. 1 is shown an ordinary two-valve circuit, so that both sides of the wave are rectified. At "A" we note that on one side of the cycle tube No. 1 is operating and that tube No. 2 is idle. You can easily follow the arrows and note that the filament center tap is positive in polarity. You can prove this by testing with a galvanometer. In this circuit, then, we find that the current in the

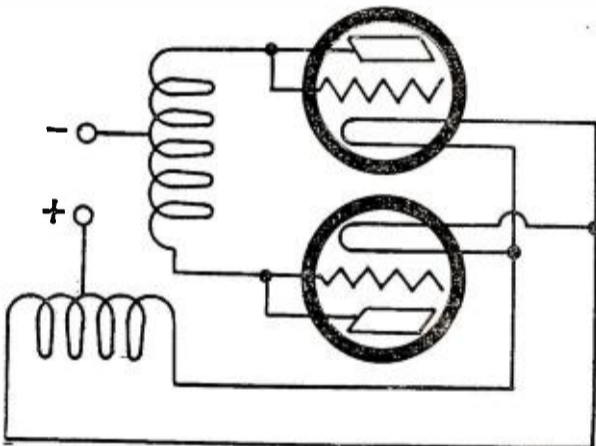

C. RADIO NEWS 1922

FIG. 2

Three Electrode Vacuum Tubes may be Used as Rectifiers by Connecting the Grids and Plates Together.

tube is flowing from the plate to the filament and not from the filament to the plate.

In Fig. 1 "B," we have just the opposite effect. Tube No. 1 is idle and tube No. 2 is working. However, the middle tap of the filament lighting circuit is still positive. This being the case, it is not a hard matter to again trace the flow of the current through the secondary winding (high voltage winding) and the vacuum tube No. 2.

The best tubes on the market for rectification are the kenotron UV216 tubes. With two such tubes working on a 50-watt transformer at 350 volts, the author obtained as high as 200 milliamperes.

Some results were had by using receiving or amplifying tubes for rectification purposes. The author merely connected the grids and plates together and inserted them in the circuit in place of the UV216's, see Fig. 2. With various kinds of tubes, the author has obtained from 80 to 100 milliamperes from this form of rectifier. This method is not recommended because it may result in the destruction of many receiving tubes, owing to the close spacing between

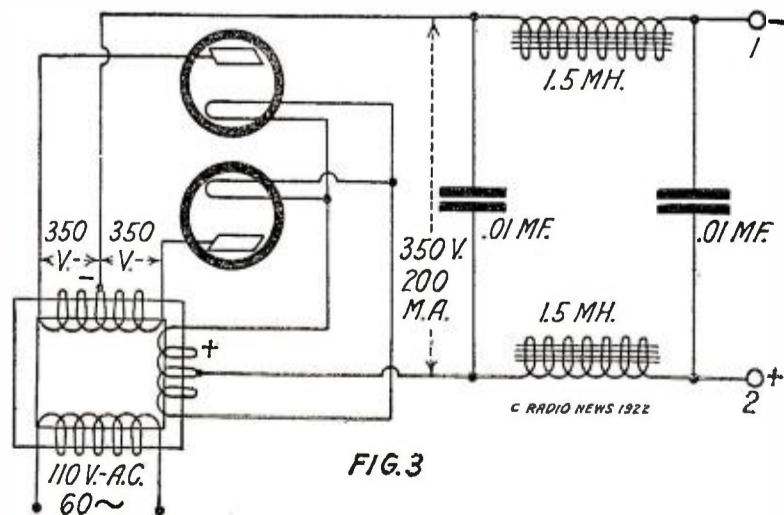

FIG. 3

Complete Circuit of a Rectifier and Filter Using Kenotron Tubes, Suitable for a C. W. or Phone Transmitter.

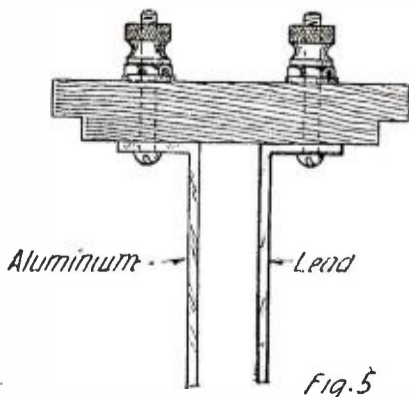

Fig. 5

The Electrodes for an Electrolytic Rectifier May be Fixed Upon the Top of the Jars Containing the Electrolyte.

Correspondence From Readers

RADIOBUGHOUSEOLOGY

Editor, RADIO NEWS:

After reading of Mr. Horle's experiments with Insect-Radio and then of Sergeant Zimmerman's, it occurred to me that Radio might be used as a bug exterminator; and why not if we can but get the wave-length of the bug we wish to kill and then send with enough power to burn out his receiver? That should kill the bug, and it would search out all the bugs within range, no matter where.

Just suppose that you could send out an impulse on the housefly-wave and kill all of them in town. Wouldn't that be fine? Now if insects are using Radio, all that stands in the way of such practice is getting a transmitter to radiate on such short waves, and send out enough energy to kill the insect in the case.

This principle could be applied to any number of insects from the malarial mosquito to the small red ants that infest our cupboards. It might even be applied to disease germs and used to cure the ills of humanity.

Surely it would seem to be worth research by some well-equipped laboratory because the financial return from a successful insect-exterminator would be enormous. One has but to consider the amount spent in spraying trees to see that.

I hope I have furnished food for thought.

RAYMOND M. MOORE.

Tucson, Ariz.

If this sort of thing continues we shall soon have to add a new department entitled "Radiobugology"!!—EDITOR.

NEW RADIO LAW WILL STOP THIS

Editor, RADIO NEWS:

In regard to the broadcasting wave-lengths, cannot something be done? Monday night, April 3, I invited a few friends to listen to KDKA, but we didn't. I just got him nicely tuned in, and in came WWJ, and in a few minutes along came KYW, and I could not tune them out because they were all on 360 meters. I have a home-made variocoupler and two variometer sets, and can get any of them in fine with a Baldwin type C unit and phonograph horn on a single bulb and a 60' single wire 45' high, but I can not tune out on the same wave-lengths.

Why can't the different broadcasting stations split up on a five meter difference? Almost anyone could tune out interference on five meters, unless my set is exceptional. I can tune out the N of M, 20 miles away, and get KOKA, clearly, when he is sending on 385 in code and KOKA on 360 meters.

Also, why can't amateurs use 150 to 185 and 215 to 250 for broadcasting music, without interfering with the 200 wave for DX work?

A. C. FISHER.

Roadside Auto Inn, North St. Paul, Minn.

A NEW ECHO

Editor, RADIO NEWS:

On April 27 a new set of chimes made at the Meneely Bell Foundry at Watervliet, N. Y., were played there, and the music sent to the General Electric broadcasting station WGY, Schenectady, N. Y., by telephone (more than 20 miles away) and amplified and broadcasted by Radio. I received the concert on a home-made set, using one detector bulb and two stages of amplification, with a single circuit tuner consisting of variable condenser in series with an inductance tube and tickler. This concert I transmitted back to WGY (about 30 miles) over long distance telephone, and it was heard very loudly and distinctly at the broadcasting station and the music was not all worn out either,

although it traveled over 20 miles by wire, then 30 miles by air and 30 miles more by wire to where it started.

Box 3, Thomson, N. Y.

G. W. PERKINS.

WHEN, OH WHEN, WILL IT STOP?

Editor, RADIO NEWS:

"Courtesy on the air," seems to be unknown to a large number of amateurs lately. Some through ignorance, some through carelessness and some with a "devil may care" attitude, let their waves get above 200 meters; stations 25 miles away, that is, amateur stations, are QSA above 600 meters, while others can be heard up to 1,500 meters. Some are sharp around 300, while others are just as clear at 600 as they are at 150 meters or any place in between.

We also have the fellow who sits on his key with his aerial in, and adjusts his "rotary," with full power on.

Then there is the fellow with the two Ford coils; he never heard of an oscillation transformer and thought that wave-length was the distance between two stations. He is learning the code with the secondary of his coils hooked to his aerial.

The school boy who has just put in a transmitter rushes home from school, slams

Some of the Interesting Articles Appearing in the July Issue of Practical Electrics

Electrogeoscopy

By T. O'Connor Sloane, Ph. D.

A Laboratory Ultra-Violet Electric Lamp

True Electrical Experiences (cont'd)

By H. Winfield Secor, Assoc.

Member, A. I. E. E.

Thermo-Dynamic Electricity

By F. R. Kingman

Tesla's Electrolytic Clock

By E. Moen

Electric Lighted Violin Bow

in his aerial switch and calls his chum across the street, (he didn't think anybody else was using the air on the same wave-length) and then hammers away for a half hour with full power, on something he could walk across the street and say in five minutes. It is nice to keep in practice, but why ruin the air when less power will get it across?

During the broadcasting period, if a record is being played, especially if it is jazzy, everything else is quiet, but the minute a good artist gives a little "real" entertainment some "ham" thinks he has to call a station 4,000 miles away and does it on any wave length above 200 meters, and then wonders why there is talk about suppression of the amateur.

There are only a few fellows who do these things, but it is hard on the rest because they all get blamed for it and if the fellows who read this would think a little about it, they would see why the Government is taking matters in hand and trying to get more laws to regulate amateur transmission.

HENRY MORRIS,
Monrovia, Calif.

FIRST AMATEUR OVERSEA TRANSMISSION

Editor, RADIO NEWS:

I have just seen the statement in RADIO NEWS that the first amateur transmission to be heard was that of IBCG by Mr. Green-slade. That, however, is not quite in ac-

cordance with the facts. On December 8, 1921, at 2:30 A. M., G.M.T. I heard the transmission of 2FP sending HUZXXJ. He was so loud that I heard the signals with the phones on the bench. As this was the first code transmission, 2FP is to be heartily congratulated on his great achievement, for undoubtedly he was the first to push his signals over here. I may add that on this, the first morning, I also copied 2BML, IUN, and IXM. Thus I heard four different stations before anybody else heard them. Then again, on December 11, I heard this radio to 2DA from 2FP. "Expect be home (?) Friday. In Iowa. Be home. No sig." That came before the famous IBCG radio and I venture to suggest it is the first bit of relay work to be heard in this country. Be that as it may, I should very much like to know what power was being used on that occasion by 2FP.

These are just little points that might as well be cleared up and might be of interest to 2FP.

W. R. BURNE, 2KW.

"Springfield" Thorold Grove Sale,
Cheshire, England.

SAD BUT TRUE

Editor, RADIO NEWS:

I wish to congratulate Mr. Garrick on his admirable flow of "stiff words," which appeared in the June issue of the RADIO NEWS, denouncing this phone bunk. It certainly is a grand and glorious feeling to know that there is still at least one amateur who has not become a phone "bug," and I would like him to know that there is another who sympathizes with him.

Many of the wise birds point to the phone as being the making of radio, but in my estimation it will be the ruination of it before long. Many amateurs are becoming disgusted, and are not bothering with their transmitters any longer, because it is practically impossible to do any distance work. What is the logical outcome? There is going to be a scarcity of commercial operators, for the amateurs of today are the commercials of tomorrow, and all because, when a fellow's interest in code work begins, it is knocked in the head by these broadcasts.

About the only thing the phone is doing is to create a great demand for receiving apparatus, which is benefiting the manufacturers, and to afford a valuable means of advertising. In a recent issue of RADIO NEWS I read an article stating that it was proven that when one of the Broadway musical comedies was broadcasted by radio, the attendance the following week was greater than ever, and that thousands of people were turned away because they could not buy tickets. Now take the amateur; on the night it was broadcasted, think of the fellows who were saying nasty things because they could not work stations they used to work, on account of QRM. And still they say that it is helping radio.

Come on you phone bug: —QTC?

LEWIS H. NEWMANN,
Philadelphia, Pa.

NAVAL AIR STATION PROTESTS

Editor, RADIO NEWS:

Referring to page 1082, June issue of RADIO NEWS, title "A Practical Two Way Key."

Mr. Davenport gets off the point when he stops to "shoot a line" about the Navy standard key and a standard speed of 10 words. Perhaps that is all he is capable of, but it gives the general public a poor impression of aircraft radio in the Navy and I would greatly appreciate your giving this letter space in an early issue.

(Continued on page 306)

RADIO PHONE SECTION

A 200-Watt A.C. Radiophone Transmitter

By I. R. LOUNSBERRY*

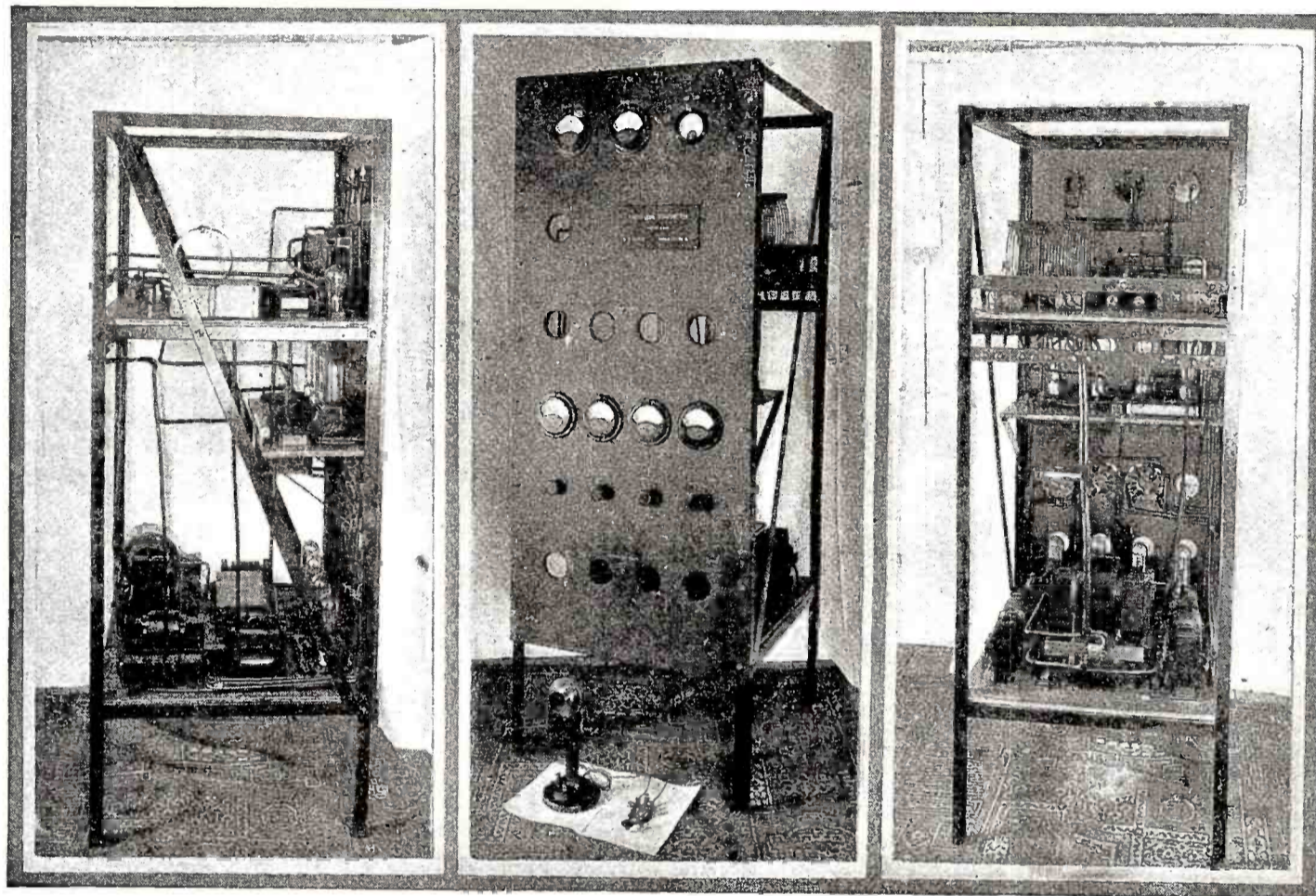

Three Views of the 200-Watt Phone and C. W. Transmitter Built by the Author.

Knoxville, Tennessee, reported night reception often, and also daylight work occasionally. Operating for an hour and a half one night 18 stations were worked—many of them 500 miles away, and 56 reports were received during the next few days via mail, reporting the speech reception. Inasmuch as no broadcasting was done, the results of the tests are very much more valuable. Operators, due to brevity of conversation, had little opportunity for close adjusting, so that it is safe to say that with better tuning time, the results would have shown much better distance.

GENERAL CIRCUIT

The Colpitts oscillator circuit was found to give better results under existing antenna conditions than any other. The modulating system consisted of the Heising circuit with a voice amplifier.

Alternating current was used throughout the entire circuit except for relays and microphone. Four 50-watt Radiotrons were used in radio circuits and a 5-watt Radiotron was used for the voice amplifier. In the rectifier circuit four 50-watt Kenotrons were used. The filaments of the rectifiers were connected in parallel and run off an Acme 300-watt transformer designed for a 12-volt potential at its output terminals. Control of the output was effected by five taps on the primary winding. The four Radiotrons were operated in a like manner together with

(Continued on page 328)

ABOUT eighteen months ago Radio Station 2BQH, owned by Mr. W. R. Seigle, Mamaroneck, N. Y., was equipped with 1-K.W. phone set of a standard make. This set employed a motor generator, and in operating was found to be very cumbersome and unsatisfactory. In seeking better methods, the many advantages of alternating current were very well thought of and it was decided to build an A.C. phone WITH A FILTER.

Inasmuch as a phone was already installed at 2BQH it was decided to carry on the tests of the set at 2BB, owned by the writer, at Ossining, N. Y. The resultant circuit was tested during December, January and February with excellent results. In testing, special attention was paid to comments of "checkers" as to A. C. interference. The filter designed was so effective that in almost every case we were reported as using motor generator for plate supply instead of rectified A. C.

In making our tests a great deal of cooperation was given by our fellow radio men who very kindly wrote us, not once, but often. Our one regret is that it was found impossible to answer the great volume of correspondence, which, in many cases, asked for full particulars re circuit, power, constants, etc., and it is hoped through this medium to reciprocate for their kindness. It was also for this reason that the transmitter was on exhibition during the Second District Radio Convention held at the Pennsylvania Hotel, New York City.

A few instances regarding results during

*Radio Engineer for W. R. Seigle.

tests might well be mentioned here. Voice transmission was used entirely with the exception of one night, at which time the I. C. W. was heard by 5ZA at Roswell, New Mexico, a distance of 1,800 miles. The voice was often heard in Florida, Kentucky, Tennessee, Missouri and as far north as Nova Scotia. The best voice distance was Fairmont, Minnesota, where it was heard plainly, a distance of 1,400 miles. Station 5XK at

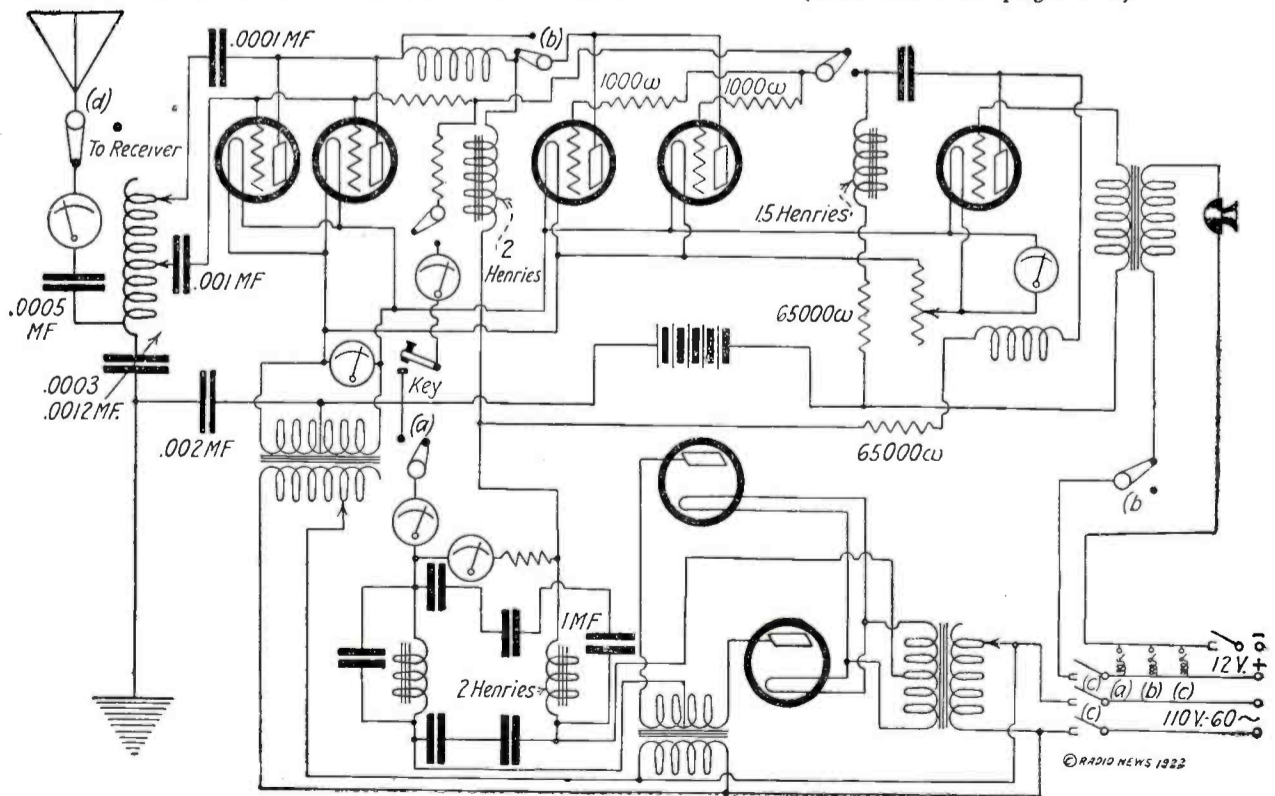

Diagram of a Phone and C. W. Set Entirely Supplied With A. C.

Radio Digest

MUSICAL BROADCASTING EXPERIMENTS

It is not always that the public benefits with experimental work, but in the case of the radio development in broadcasting music at Anacostia, naval radio experts are letting the public in. Every Wednesday night from 8:30 to 9:30 the Marine Band plays for entertainment on 412 meters sent out by NOF, and it is all part of development work.

The broadcasting of speeches and music from a large room has met with difficulty due to distortion, reverberation and the inclusion of outside noises; even the most successful transmission of music shows considerable distortion, according to naval experts, but the music is nevertheless received and enjoyed by 90 per cent. of the receiving stations. The difficulty is in securing an acoustically perfect room for transmission. At Anacostia this is accomplished by enclosing part of the room used so as to make a 15-foot square studio. It is enclosed in loosely hung curtains of airplane cloth, which deadens all sounds and echoes.

A large number of letters received since the band has played have commended the work and offered some valuable criticisms. Solos and duets go best, it is said. On the evening of May 17th a selected orchestra of 12 pieces played with good results judging from the letters received by the band leader and radio operator. The drum has been eliminated, but a means of successfully muffling it may be found. Brasses, it is found, reverberate more than string instruments. The violin carries the best of the instruments experimented with, while the reproduction of the piano is found to be difficult. Under the fingers of Edith Marmion Brosius, the harp was excellent.

By using recently developed microphones in place of two No. 323 W. Western Electric instruments, improvements are expected. Better results can be had by using high and low pass filters, which ought to be used in the microphone circuits in addition to the stretched diaphragm microphones, with their periods well out of the range of ordinary audibility.

PACIFIC COAST STATES AND CITIES LEAD IN BROADCASTING

CALIFORNIA FIRST AND OHIO SECOND OF STATES, WHILE LOS ANGELES LEADS CITIES

There were 310 broadcasting stations licensed by the Department of Commerce up to June 2d to send out news, entertainment and market and crop reports. This number would have been 314, except that four stations have dropped out of the broadcasting business. These stations—one each in Illinois, California, Pennsylvania and the District of Columbia—are the only ones which have stopped broadcasting since last June, according to officials of the Department of Commerce Radio Section; whereas new stations are being licensed at the rate of about three per day.

California takes the lead in broadcasting development, according to late figures, with 60 stations. Ohio is next with 23, Pennsylvania and New York are tied for third with 20 each, and Washington is a close fourth with 19, Illinois has 13, Missouri 12, Texas 11 and New Jersey, Kansas and Oregon follow with 10 each.

Only six states and territories are without one of the modern sources of news, information and entertainment—Alaska, Delaware, Idaho, New Hampshire, Kentucky and South Carolina—although there are several states with but one station.

Los Angeles, like its progressive state, leads other cities in the number of broadcast-

ing stations, with 19 in that city; Philadelphia is second with 7; and San Francisco, Seattle, Portland, New Orleans and Minneapolis have 6 each; while New York, Chicago, Washington and St. Louis have 5 each. It is obvious that the Pacific Coast states and cities lead in this development.

BROADCASTING STATIONS BY STATES AND CITIES

Alabama, 2—Birmingham 1, Montgomery 1.
Alaska, 0.
Arizona, 2—Phoenix 1, Tucson 1.
Arkansas, 4—Fort Smith 1, Little Rock 2, Pine Bluff 1.
California, 60—Altadena 1, Bakersfield 2, Berkeley 2, El Monte 1, Eureka 1, Fresno 2, Gridley 1, Hollywood 1, Long Beach 1, Los Altos 1, Los Angeles 19, Modesto 2, Monterey 1, Oakland 4, Pasadena 2, Pomona 1, Redwood City 1, Reedley 1, Sacramento 1, San Diego 4, San Francisco 6, San Jose 2, Stockton 2, Sunnyroll 1.
Colorado, 5—Colorado Springs 1, Denver 4.
Connecticut, 3—Greenwich 1, Hartford 1, New Haven 1.

Radio Articles Appearing in July Science and Invention

The Radiophot—Television by Radio
By H. Gernsback
Freaks of Railroad Radiophone
By A. P. Peck
French Radio Station at Night
Radio For The Beginner—No. 5—
How a Radiophone Receiver Makes
You Hear Sounds From Afar
By Armstrong Perry
Radio Amplification—Best Methods
By Robert E. Lacault
Simplest Radio Receiver
By Leon Webster, Winner of
\$50.00 Third Prize
Radio Broadcast
Photos of Radio Broadcast Stations
Radio Oracle—Question and Answer
Box

Delaware, 0.
District of Columbia, 5—Washington 5.
Florida, 3—Jacksonville 2, Tampa 1.
Georgia, 5—Atlanta 3, Decatur 1, College Park 1.
Hawaii, 2.
Idaho, 0.
Illinois, 13—Chicago 5, Decatur 2, Peoria 1, Quincy 2, Springfield 1, Tuscola 1, Urbana 1.
Indiana, 7—Anderson 1, Indianapolis 2, Richmond 1, South Bend 1, Terre Haute 1, West Lafayette 1.
Iowa, 5—Ames 1, Centerville 1, Davenport 1, Des Moines 1, Fort Dodge 1.
Kansas, 10—Anthony 1, Atwood 1, El Dorado 1, Emporia 1, Lindsborg 1, Manhattan 1, Wichita 4.
Kentucky, 0.
Louisiana, 8—New Orleans 6, Shreveport 2.
Maine, 1—Auburn 1.
Maryland, 2—Baltimore 2.
Massachusetts, 6—Boston 1, Medford Hillside 1, New Bedford 1, Springfield 1, Worcester 2.
Michigan, 7—Bay City 1, Dearborn 1, Detroit 3, E. Lansing 1, Flint 1.
Minnesota, 8—Minneapolis 6, Northfield 1, St. Paul 1.
Missouri, 12—Columbia 1, Jefferson City 1, Kansas City 4, St. Louis 5, St. Joseph 1.
Montana, 1—Great Falls 1.
Nebraska, 4—Omaha 3, University Place 1.

Nevada, 2—Reno 2.
New Hampshire, 0.
New Jersey, 10—Camden 1, Jersey City 1, Moorestown 1, Newark 4, Paterson 1, Plainfield 1, Roselle Park 1.

New Mexico, 2—Roswell 1, State College 1.

New York, 20—Albany 1, Buffalo 2, Canton 1, Ithaca 2, Newburg 1, New York 5, Ridgewood 1, Rochester 1, Schenectady 2, Syracuse 2, Tarrytown 1, Utica 1.

North Carolina, 1—Charlotte 1.

North Dakota, 1—Fargo 1.

Ohio, 23—Akron 1, Athens 1, Canton 1, Cincinnati 4, Cleveland 1, Columbus 1, Dayton 1, Defiance 1, Danville 1, Hamilton 2, Marietta 1, New Lebanon 1, Portsmouth 1, Toledo 3, Youngstown 2, Zanesville 1.

Oklahoma, 2—Muskogee 1, Oklahoma City 1.

Oregon, 10—Eugene 2, Klamath Falls 1, Hood River 1, Portland 6.

Pennsylvania, 20—Bridgeport 1, Brownsville 1, Clearfield 1, Crafton 1, East Pittsburgh 1, Erie 2, Harrisburg 1, McKeesport 1, Philadelphia 7, Pittsburgh 2, Wilkes-Barre 1, Villanova 1.

Rhode Island, 1—Edgewood 1.

South Carolina, 0.

South Dakota, 1—Rapid City 1.

Tennessee, 3—Memphis 2, Nashville 1.

Texas, 11—Amarillo 1, Austin 1, Dallas 2, El Paso 1, Fort Worth 2, Houston 2, Paris 1, San Antonio 1.

Utah, 3—Salt Lake City 2, Ogden 1.

Vermont, 1—Burlington 1.

Virginia, 2—Norfolk 1, Richmond 1.

Washington, 19—Aberdeen 1, Bellingham 1, Centralia 1, Lacey 1, Seattle 6, Spokane 2, Tacoma 2, Wenatchee 3, Yakima 2.

West Virginia, 3—Charleston 1, Huntington 1, Morgantown 1.

Wisconsin, 3—Madison 1, Milwaukee 2.

RADIO CIRCLES GLOBE

Radio time signals sent out from the Annapolis Station have been heard at the Antipodes, or half-way around the world. According to C. E. Adams, official astronomer and seismologist at the Hector Observatory, Wellington, New Zealand, time signals sent by the radio from the Naval Station at Annapolis, Md., were heard distinctly by him. Another report received by the Naval Observatory from Australia stated that the time signals had been heard there within a fraction of a second after their transmission, apparently coming both ways around the world.

RADIO EXPORTS

Radio apparatus exported from the United States to foreign countries totaled \$21,180 for March, according to the Bureau of Foreign and Domestic Commerce, Department of Commerce. The greatest amount, nearly ten thousand dollars' worth, went to Japan, Canada being next with importation of radio apparatus valued at \$6,761.

BROADCASTING STILL INCREASING

With the licensing of 18 more broadcasting stations recently by the Department of Commerce, the country now has 253 stations sending out news, entertainment, and Government information. On March 10, there were but 67 stations broadcasting, showing that the number has practically quadrupled in two months, and that new stations are being licensed at a rate of three a day.

It is not strange that everyone is wondering how long it will be before the ether is literally filled with music, news, market and weather reports, and the need for legislation is obvious. To aid the Secretary of Commerce in controlling commercial and amateur radio transmission, particularly radio tele-

(Continued on page 314)

The Sensitivity and Precision of the Electrostatic Transmitter for Measuring Sound Intensities

By E. C. WENTE*

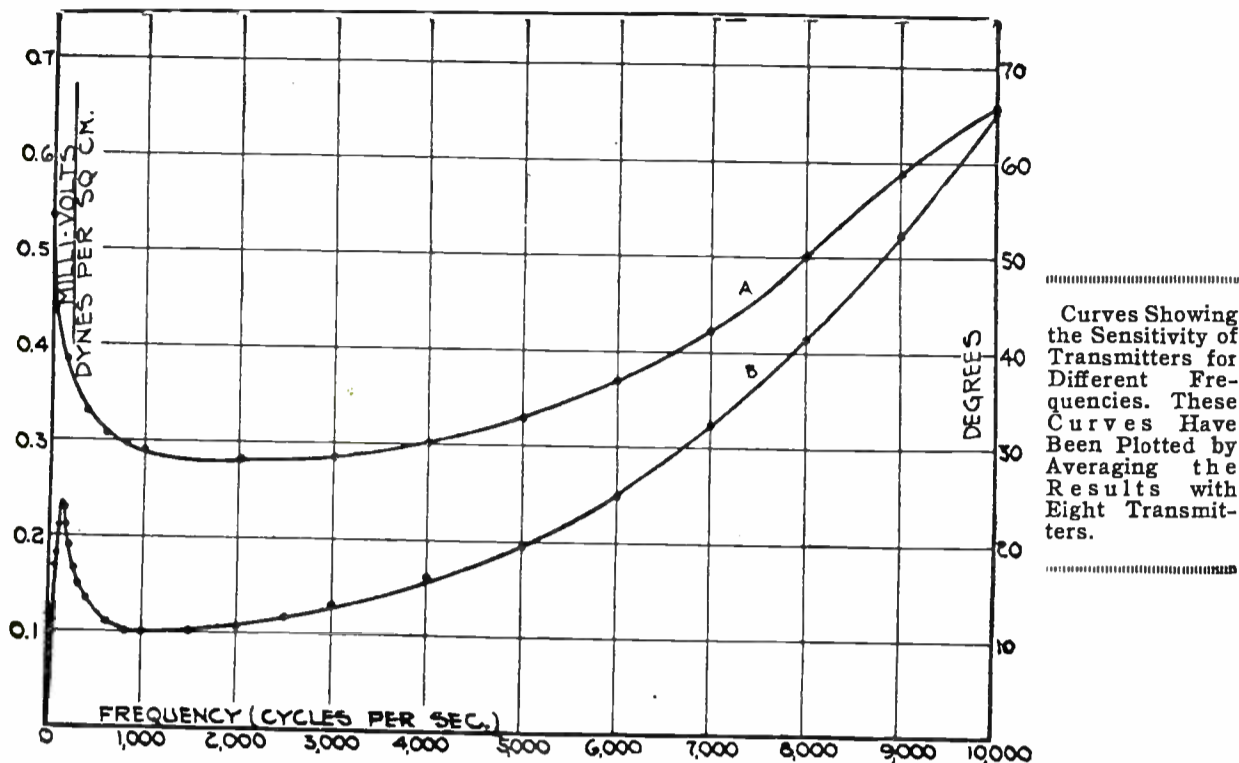

Fig. 2.

THE writer some years ago published a paper in the *Physical Review* on the use of an electrostatic transmitter for the absolute measurement of sound intensities. The transmitter, as there described, consisted essentially of a thin metal diaphragm under tension separated by a small distance from a plane metal plate, the plate and diaphragm forming the two electrodes of an air condenser. Data were given which showed that the instrument had a uniform sensitivity over a wide range of frequencies and so was especially adapted for the measurement of intensities of sounds of various frequencies.

The relation between sensitivity and frequency was determined by means of a thermophone and also, at the lower frequencies, by means of a piston-phone. But, as the two methods did not yield the same absolute values doubts were cast upon the accuracy of the results. Since then the theory of the thermophone has been further developed and corrected formulæ for its acoustic efficiency have been obtained. The pressures calculated by these new formulæ have been found to agree with those given by a piston-phone, so that an absolute calibration of a transmitter may now be made with the thermophone which is dependable over a wide frequency range.

The particular electrostatic transmitter described previously had a natural frequency of nearly 17,000 cycles per second. As this frequency is considerably beyond the region which is covered in most acoustic measurements, it is desirable to construct an instrument with a lower natural frequency and thereby obtain greater sensitivity. Dr. I. B. Crandall has shown theoretically how the natural frequency and damping of an electrostatic transmitter may be given almost any desired values by cutting grooves of the proper size in the back plate.

The transmitter which is here described has a natural frequency of slightly over 10,000 cycles per second and a damping constant of 14,000. The sensitivity-frequency characteristic is such that an amplifier may readily be constructed so that the sensitivity of the amplifier and transmitter combined shall be nearly the same from 25 to 8,000 cycles per second. Tests have shown that the sensitivity of the transmitter is closely maintained under various atmospheric conditions for a long period of time.

*Research Laboratories of the American Tel. & Tel. Co. and The Western Electric Co.

CONSTRUCTION OF THE TRANSMITTER

A sectional drawing of the transmitter is shown in Fig. 1. The transmitter differs from the instrument previously described in several essential respects. The diaphragm, A, is made of 0.002 inch (0.0051 cm.) steel and is stretched so that its natural frequency in free air is 7,000 cycles per second. Annular grooves are cut into the face of the back-plate, B, to give the diaphragm the desired natural frequency and damping. The length of the air-gap is 0.001 inch (0.0025 cm.). To keep out moisture, the space surrounding the back-plate is sealed off completely from the outside air. A thin rubber diaphragm, C, is provided to keep the pressure on the two sides of the steel diaphragm substantially equal under all conditions of temperature and atmospheric pressure.

CALIBRATION OF THE TRANSMITTER

The open-circuit voltage of the transmitter per unit of pressure has been measured with the piston-phone for the frequency range of 10 to 200 cycles per second and with a thermophone for the frequency range of 60 to 12,000 cycles per second. Both of these instruments have been described in another paper. The method of measurement was virtually the same as previously described, except that an a.c. potentiometer was used in place of a thermo-couple and galvanometer. The polarizing voltage in all cases was 200.

Fig. 2 gives the calibration curve obtained by averaging the results for eight transmitters. Between 25 and 8,000 cycles the calibration curve of none of the individual transmitters differs from this average curve by more than 20 per cent. To make all the transmitters exactly alike would require extreme precautions in construction, which would add considerably to their cost. However, even if there is a considerable variation in the mechanical constants of the individual instruments, we may obtain a very nearly correct value of the calibration curve of any particular instrument by measuring the sensitivity at 200 cycles with the piston-phone and multiplying the ordinates of the curve given in Fig. 2 by the ratio of the value so obtained to the value of the ordinate of this curve at 200 cycles. For the eight calibrated transmitters the difference between the true calibration and the values obtained by this latter method was at no point greater than 12 per cent. for frequencies lying between 20 and 8,000 cycles per second, and for most

of the transmitters the difference was nowhere greater than 5 per cent. This difference is small enough to be neglected in practically all acoustic measurements. Unless a precision greater than 5 per cent. is required it is therefore unnecessary to make any other measurements on transmitters of this type than that of the determination of the sensitivity at 200 cycles by means of the piston-phone, a measurement which may be made in a few minutes.

Fig. 2 shows that the sensitivity of the transmitter is not independent of frequency. However, since the transmitter is generally used with an amplifier, the sensitivity varies with the frequency in a desirable way. An amplifier as normally constructed has an amplification characteristic which is nearly proportional to the reciprocal of the efficiency characteristic of the transmitter. At any rate, an amplifier can readily be designed so that the sensitivity of the transmitter and amplifier combined is practically uniform from 25 to 8,000 cycles.

For the frequency range of 60 to 10,000 cycles a determination was also made of the phase relation between the pressure exerted on the diaphragm and the voltages generated by the transmitter. The values that were obtained are also plotted in Fig. 2. The maximum in the curve at 200 cycles is due to the fact that the damping of the diaphragm by the air in the gap increases with decrease in frequency.

VARIATION OF SENSITIVITY WITH TIME

To determine the change in sensitivity of the transmitter with time under ordinary conditions of use it would be necessary to make measurements extending over a long period. The more practical method of subjecting the transmitter to a higher temperature for a shorter period of time was therefore adopted. A transmitter was heated daily for 5 or 6 hours to about 45° C. and then allowed to cool to room temperature. No change in efficiency was observable even after this process had been continued for more than two weeks. The precision of the measurements was about 2 per cent. The transmitter was then heated to 100° C. for several hours. After being allowed to cool it was again tested but no change in sen-

(Continued on page 296)

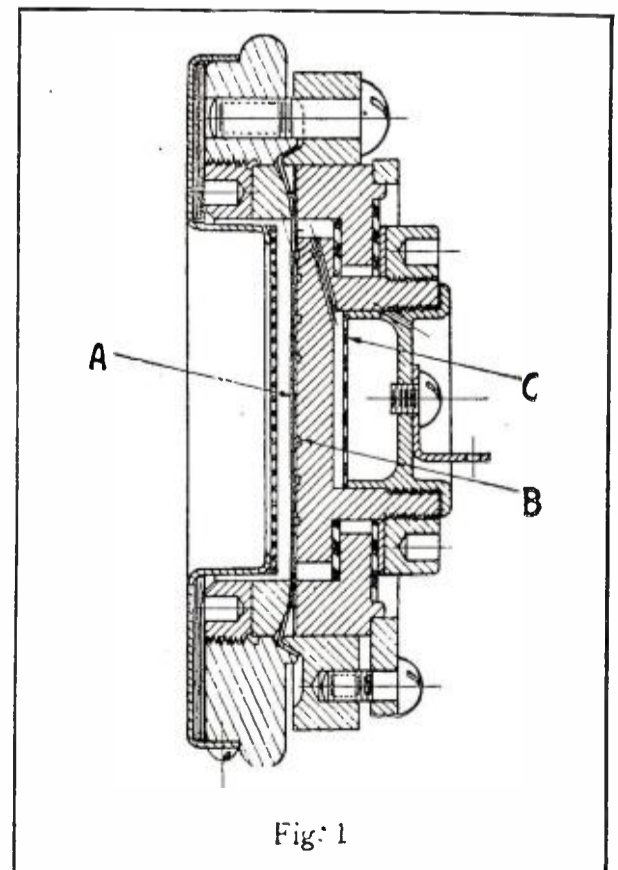

Fig. 1

Sectional View of the Type of Transmitter Used in the Experiments Described in this Article.

The Armstrong Super-Regenerative Circuit

AT the meeting of the Institute of Radio Engineers, June 7, a new receiving circuit of great importance was outlined by its inventor, Mr. E. H. Armstrong, who is already famous for his contributions to the art of radio. The regenerative circuit and the super-heterodyne were the two earlier circuits, each of vast importance, which brought fame to their inventor. The new circuit is known as the "super-regenerative" and a successful demonstration was given of the practical application of the theories presented in the paper read by Mr. Armstrong. Using a loop aerial and only three tubes, speech and music from the broadcasting station at Newark, New Jersey, were received and amplified sufficiently loud to fill the large meeting room of the Institute. Mr. Armstrong explained, incidentally, that the building was almost radio-proof so far as reception by means of a loop was concerned.

The advantages of the super-regenerative circuit are numerous, and it seems as though it may provide the solution of many of the existing problems in the reception of radio telephony. The amplification is so enormous by this new system that the signal strength obtainable with two tubes is equal to that obtained with four or five tubes by existing methods.

Another remarkable feature of the circuit is that it can be adapted for the reception of telephony to the exclusion of spark signals. This is an entirely new departure and its advantage is evident. At present, even the most selective receiver cannot entirely eliminate spark interference if the spark station is transmitting on nearly the same wave-length as the radio telephone station it is desired to receive. In some cases, improperly tuned spark transmitters interfere over a broad band of wave-lengths. The super-regenerator adapted for the receiving of telephony does not receive these spark stations. In demonstrating this feature, Mr. Armstrong explained that in-

This circuit is most efficient for the reception of modulated C. W. and Spark Signals so that they are heard with their true tones. As may be noted, a separate detector tube is used

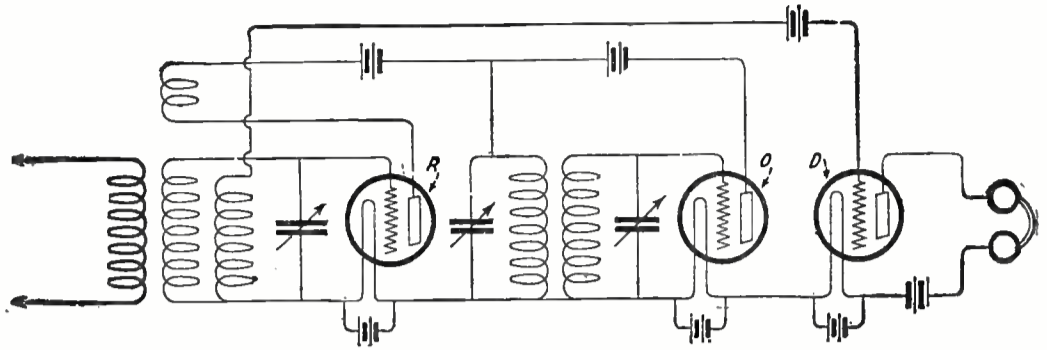

coming spark signals set up free oscillations in the ordinary regenerative circuit and the greater part of the energy is contained in these. The free oscillations are not permitted to build up in the super-regenerative circuit. By means of a special heterodyne system, the resistance of the receiving cir-

cuit is made alternately positive and negative at a definite frequency. If the super-regenerative circuit becomes popular, spark coil enthusiasts may fill the air with CQ's without a protest so far as the radiophone listeners are concerned. Hitherto, amplification of the high frequencies of short waves has been extremely

difficult, but these high frequencies present no obstacle to the super-regenerative circuit. The amplification obtainable is as great as that obtainable on longer waves and it is handled with equal facility; in fact, the reproduction of speech is much better on the short waves than on the long waves as there is a tendency toward chopping effect on the lower frequencies of the longer waves.

In common with Mr. Armstrong's other inventions, the super-regenerative circuit undoubtedly provides a means of amplification of short waves to a degree which has hitherto been impossible except by the use of eight or nine tubes. This practically means that the same degree of amplification of short waves, at present attained with a super-heterodyne, may possibly be reached with the super-regenerative circuit using only two or three tubes. The new circuit, however, is superior to the super-heterodyne, as it can amplify, with no difficulty, much higher frequencies than any other method. Already wave-lengths of about 50 meters have been successfully handled and

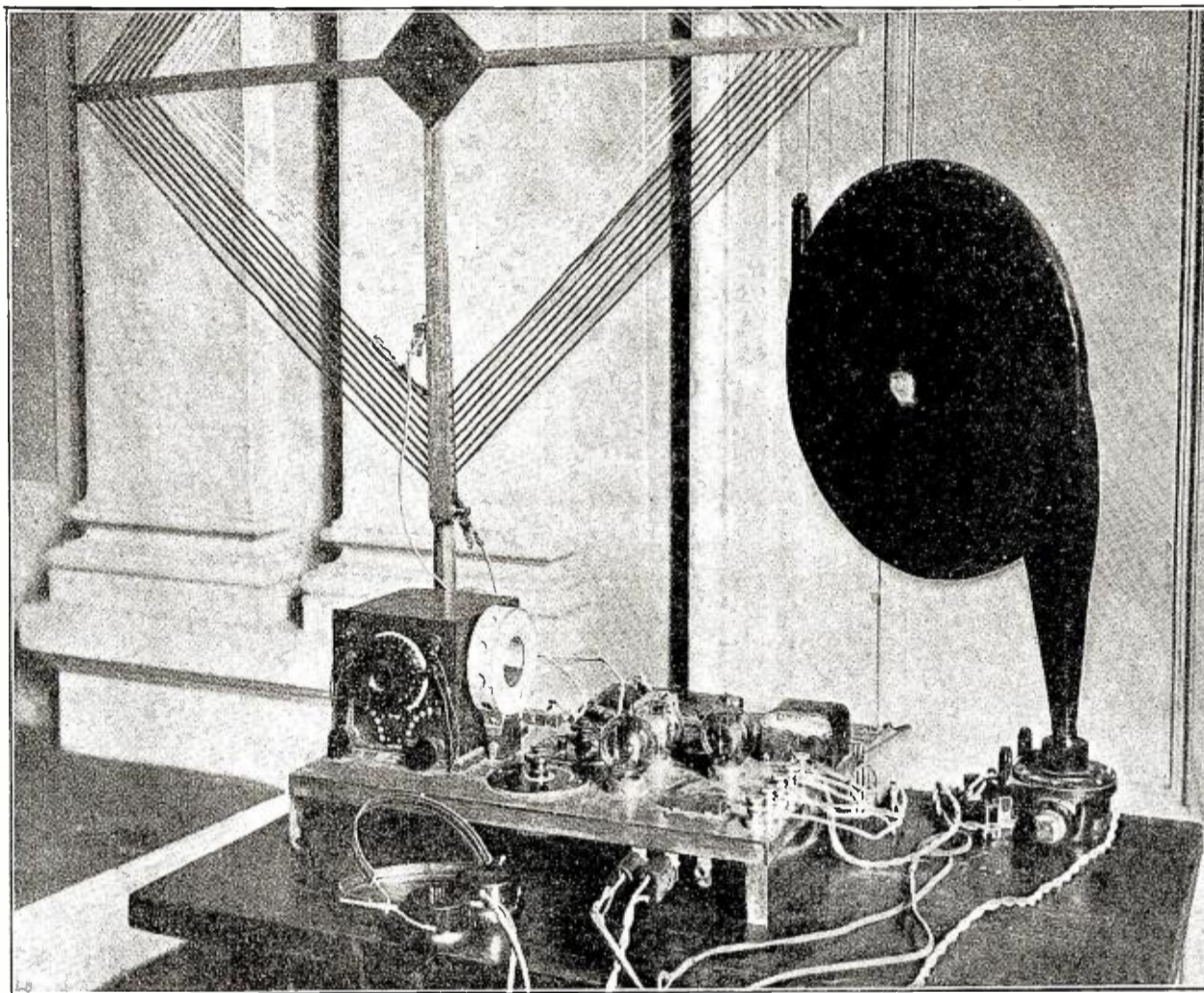

The Super-Regenerative Set Used by Major E. H. Armstrong at the Institute of Radio Engineers, for the Demonstration of the Wonderful Amplification Obtainable With the New Circuit. The Third Tube on the Right Acts as Audio Frequency Amplifier to Operate the Loud Talker.

there is nothing to prevent the amplification of even shorter waves. This feature, in itself, opens up an entirely new field. At the present time, very little transmission or reception is effected below 150 meters, as it has been impossible to efficiently amplify such high frequencies. The super-regenerative circuit, however, may make it possible to utilize the unused zone below 150 meters. If this is accomplished, interference between stations will be almost an impossibility, as a difference in wave-length of one or two meters would represent a difference in frequency which could only be obtained by a large variation in wave-length at the lower frequencies of longer waves.

The only apparent disadvantage of the new system is the difficulty in tuning and, unless this can be improved, it may prevent its use by those unfamiliar with the operation of receiving apparatus. There are very few controls, but each one gives the impression that 17 separate heterodynes with as many harmonics are being used in the circuit.

The circuit, however, is a new method of reception. Extraordinary results have been obtained and it only remains to simplify the tuning and stabilize the circuit to make it of practical use to everyone.

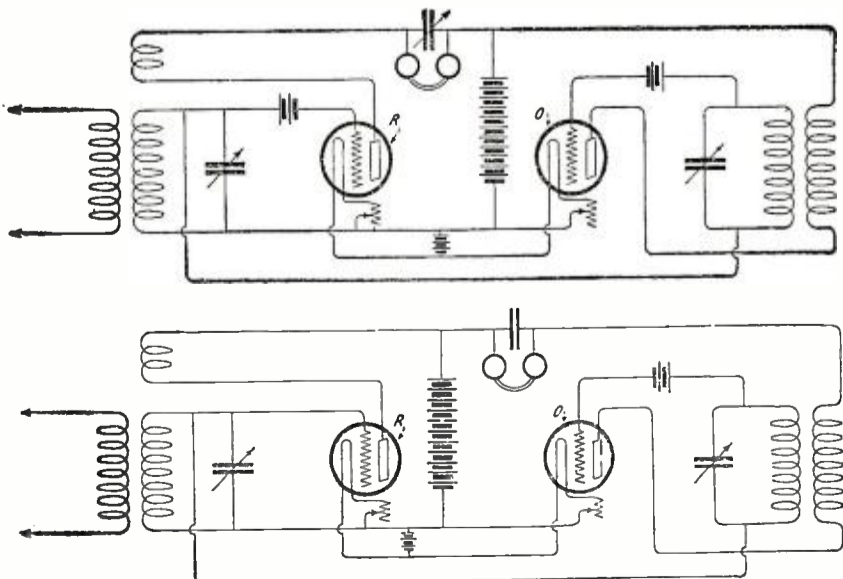

These two circuits are suitable for the reception of telephony. Either tube may be used as rectifier by adjusting the grid potential. The circuit above has been tried and has given excellent results. The characteristics were as follows: secondary L50 honeycomb, tickler L75 or L100, secondary condenser .001MF., grid battery 9 volts, "B" battery 160 volts. Grid battery for "O" 8 to 10 volts, grid coil honeycomb L1,500, plate coil L1,250, the grid coil being shunted by a .002MF. variable condenser. No phone condenser was necessary, the capacity of the cord being sufficient.

(See page 395)

The Electron Theory Simplified

By EDWARD T. BICAK

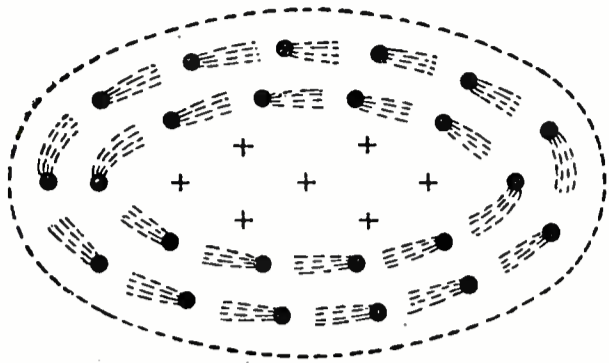

Probable Construction of an Atom Greatly Enlarged. Plus Signs Indicate Polarity of Central Nucleus About Which the Electrons (Negative Charges of Electricity) Move. The Latter Appear Like Comets in the Picture.

IF radio communication is to become the popular subject that many of the older men in the profession would have it—if the radio telephone or telegraph transmitter and receiver are to some day become as popular as the phonograph, the automobile, or similar inventions—then it is necessary that the acquisition of a knowledge of the theory underlying radio communication be made a simple matter. The general public is not in the least anxious to pore over books and articles which require highly specialized knowledge to interpret. Such material has a limited number of readers to whom it is, as a general rule, directed, and must not, therefore, be thrust too boldly before the eyes of those who have just been attracted to this art and science, since it has the detrimental effect of frightening the uninitiated reader away.

We speak so frequently of the electron theory, the topic being a common one because it is this hypothesis which makes possible intelligent understanding of that most universally applied radio device, the three-electrode vacuum tube. Notwithstanding, we are always inclined to be just a little too eager to give a mathematical exposition of the facts as we have accepted them, or to express ourselves in language which means little or nothing to the average man. Outsiders attribute this personal phenomenon to conceit or to an attempt on the part of the guilty speaker to show his cleverness, whereas the truth of the matter in all probability is that the latter may have simply grown accustomed to addressing men equally versed in the subject being discussed, as himself. Then when he meets a layman seeking what is believed to be "inside dope" on the subject, the radio man, in his anxiety to help the non-professional man fails to realize the difference in audience and gives him such a large dose of apparently meaningless words and equations as to drive the layman away thoroughly disgusted. This, of course, is not a healthy situation in the eyes of those who have the progress and best interests of radio communication at heart. Yet the radio man who fails to take cognizance of the layman's inability to correctly understand the highly scientific explanation advanced, will invariably cover up his mistake with the tale that to have made the subject more plain would have necessitated the sacrificing of scientific accuracy. Ye Gods! If we are to be so narrow-minded as to "split hairs" on the accuracy of a supposition in an instance such as this,

then we are headed in the wrong direction.

The so called *electron theory* of electricity, generally regarded with dubiety by most readers when the subject is mentioned in the daily press, can be readily explained in simple newspaper style. As previously stated, this theory is of special interest to the student of radio communication because it affords an excellent means of interpreting the actions of the popular three-electrode vacuum tube. In the following paragraphs I shall forget that I ever read some of the works of Millikan, Fournier and others from whom I acquired my acquaintance with the electron. In this way I shall be able to unfold to the uninitiated some of the secrets of the electron theory in a way which it is hoped will prove pleasant and profitable reading.

It should be thoroughly understood by the reader that although electrical energy is utilized today in doing a large part of the world's work, little has been learned regarding the true nature of electricity. At

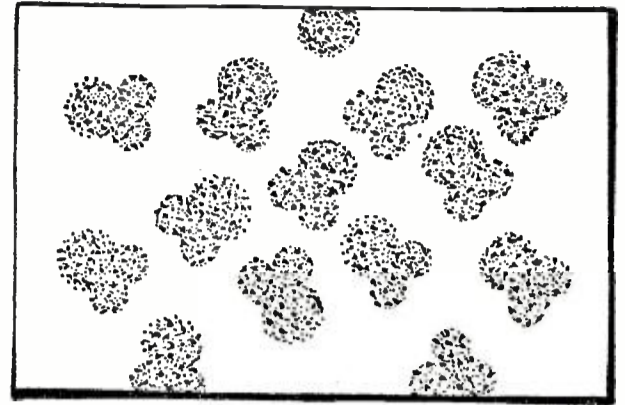

Imaginary Microscopic View of Water. The Largest Atoms in Each Group Represent the Oxygen Atoms; The Two Smaller Ones, Hydrogen Atoms.

ticular instance, but in fact denoting two different states of electrification which exhibit opposite characteristics. This electron theory although it does not tell precisely what electricity is, lends itself readily in explaining various electrical phenomena and especially the functioning of a device, already mentioned as the three-electrode vacuum tube, which has within

recent years come into extensive use in radio communication. In order that the imagination of the reader may not be too greatly burdened, a brief discussion on the automatic constitution of matter will make it less difficult to conceive the phenomena to be explained later.

Matter is the general term applied to anything that occupies space. It is anything that has dimensions and weight. Solids, liquids and gases are three different forms of matter. Thus iron, water and hydrogen are concrete examples of matter. All matter is commonly considered as being made up of a large number of distinct or separate particles

called *molecules* which, for a given substance, are all exactly alike in every respect. These so called molecules are regarded as aggregates of still smaller particles known as atoms, which may or may not be alike within the molecule, depending upon whether the substance is an element or a compound.

The molecule of an *element*, a substance which cannot by any available means be separated into two or more substances, consists of a definite number of its own atoms. A molecule of hydrogen, for example, is supposed to contain two atoms of hydrogen.

Altogether, however, there are only about 80 *elementary* substances. The molecule of a *compound*, which is a substance that by chemical means can be separated or decomposed into several different elements, consists of one or more atoms of its constituent elements. Thus, for instance, a molecule of water, the chemical symbol for which is H_2O , consists of two atoms of hydrogen (H_2) and one atom of oxygen (O). Similarly, a molecule of sulphuric acid (H_2SO_4) is made up of two atoms of hydrogen (H_2), one of sulphur (S) and four of oxygen (O_4). In common storage battery practice one often hears of lead peroxide and lead sulphate. Lead peroxide (PbO_2) is formed when one atom of lead (Pb) unites with two atoms of oxygen (O_2); whereas one atom of lead (Pb), one of sulphur (S) and four of oxygen (O_4), when combined,

(Continued on page 300)

What Do You Mean Electrons?

ARE you one who has regarded the electron theory as a subject incapable of being understood by the average mind? Or, are you a radio enthusiast who has heard so much about electrons that they seem to appear personified in your sleep, and yet find yourself trying to make "Head or tail" out of the subject when you are awake? Do you consider the electron theory a product from the minds of a few fanatics? Regardless of whether you are in either of these categories, or come under some different classification, THE ELECTRON THEORY SIMPLIFIED will not fail to interest you. This article is chiefly concerned with an explanation of the famous electron theory of electricity in language that may be understood by everybody. No figures or mathematical equations are employed. In fact, nothing but the simplest of ordinary newspaper talk is indulged in. The introduction to the article also contains a friendly word in behalf of the beginner in this most promising field, radio communication.

one time it was thought that electricity was a fluid pervading all matter, but this and numerous other theories have been discarded as a result of further investigations.

A comparatively recent and more creditable theory has been developed on the basis that all matter is made up of unit charges of electricity, called *electrons*, which are said to be of negative polarity and which are generally associated with a proportionate positive charge the exact nature of which has not been determined. The terms *positive* and *negative* are purely arbitrary, meaning neither more nor less in this par-

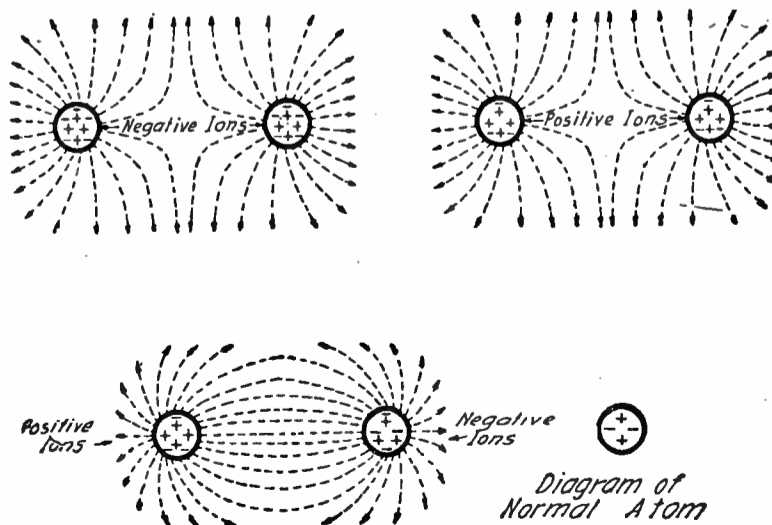

The Two Diagrams Above Show the Repulsive Force Between Two Negative and Two Positive Ions. The One Below Illustrates the Attraction Between Positive and Negative Ions.

Summer Brings the Portable Sets

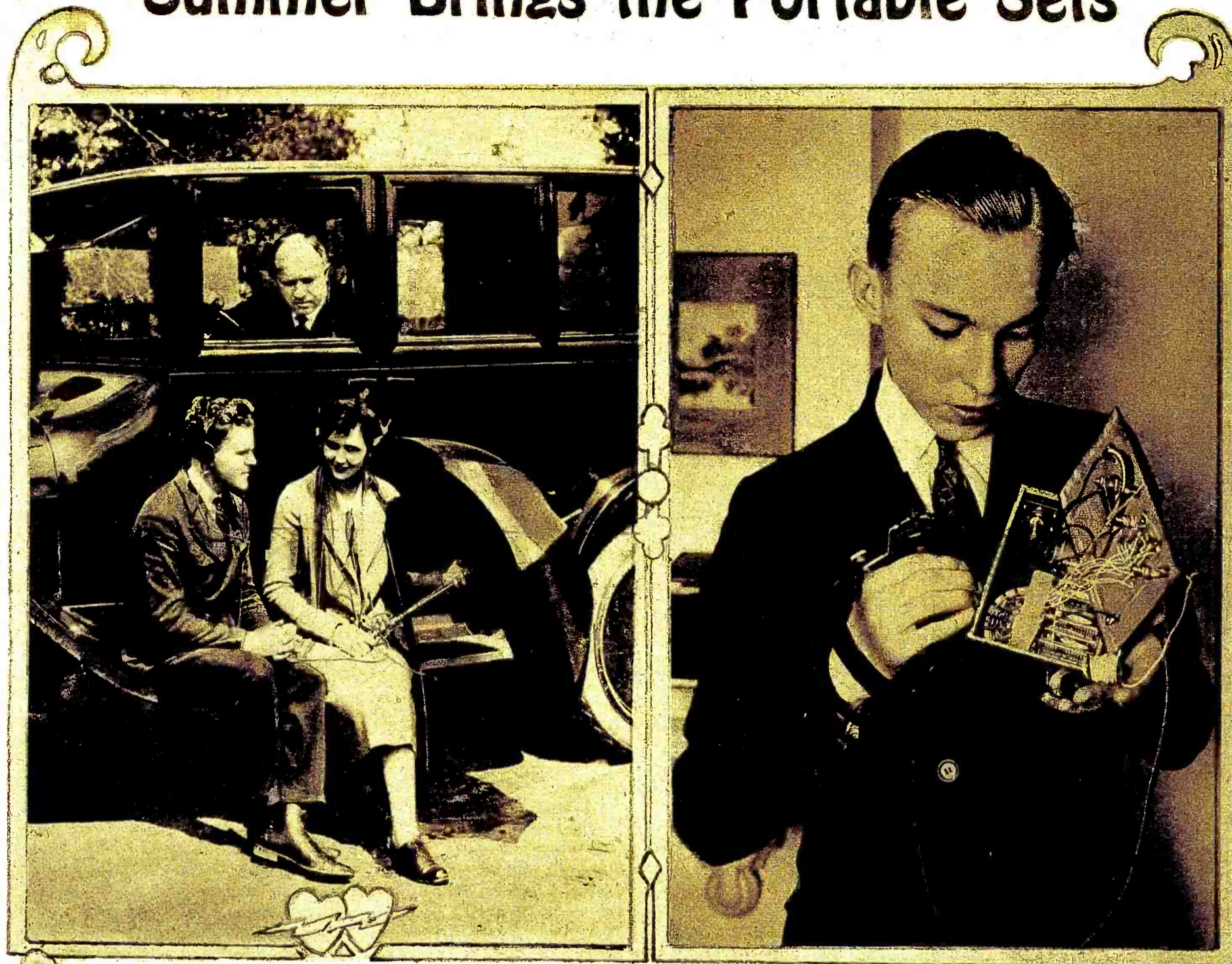

© P. & A.

Some of the Compact Receivers Which Make Their Annual Appearance for the Benefit of Summer Vacationists. The One at the Right Is a Complete Regenerative Receiver with the Tube and Batteries Included. On the Left Is a Complete Receiver Mounted in an Umbrella Which, When Open, Acts as an Aerial. Note the Wire Sewed on the Cover.

© K. & H.

© K. & H.

SUMMER has brought its annual demand for portable receivers. Enthusiasts all over the country are trying to dope out some method of putting a three-stage amplifier inside a match box. Already some have succeeded in enclosing complete crystal receivers inside tie-pins and necklaces. Probably in the near future we shall require a magnifying glass to locate an elusive super-heterodyne.

The sets illustrated on this page are a few of the summertime specials. One employs a vacuum tube as a detector and the builder was fortunate enough to possess a "peanut" tube. He has a



short wave regenerative receiver complete with tube, "A" and "B" batteries, all included in a small cigar box. This should be quite a good receiver and is remarkably compact. Another youth has a complete crystal set in a safety razor box and with a good antenna he should be able to receive fairly well with this outfit. He even has a buzzer and a battery included in this small space.

The inventive genius in the automobile illustrated above has his own ideas on umbrella-aerials and decided to put the whole receiving set on the umbrella.

President's Voice Carried to Thousands

Decoration Day Speech Broadcasted

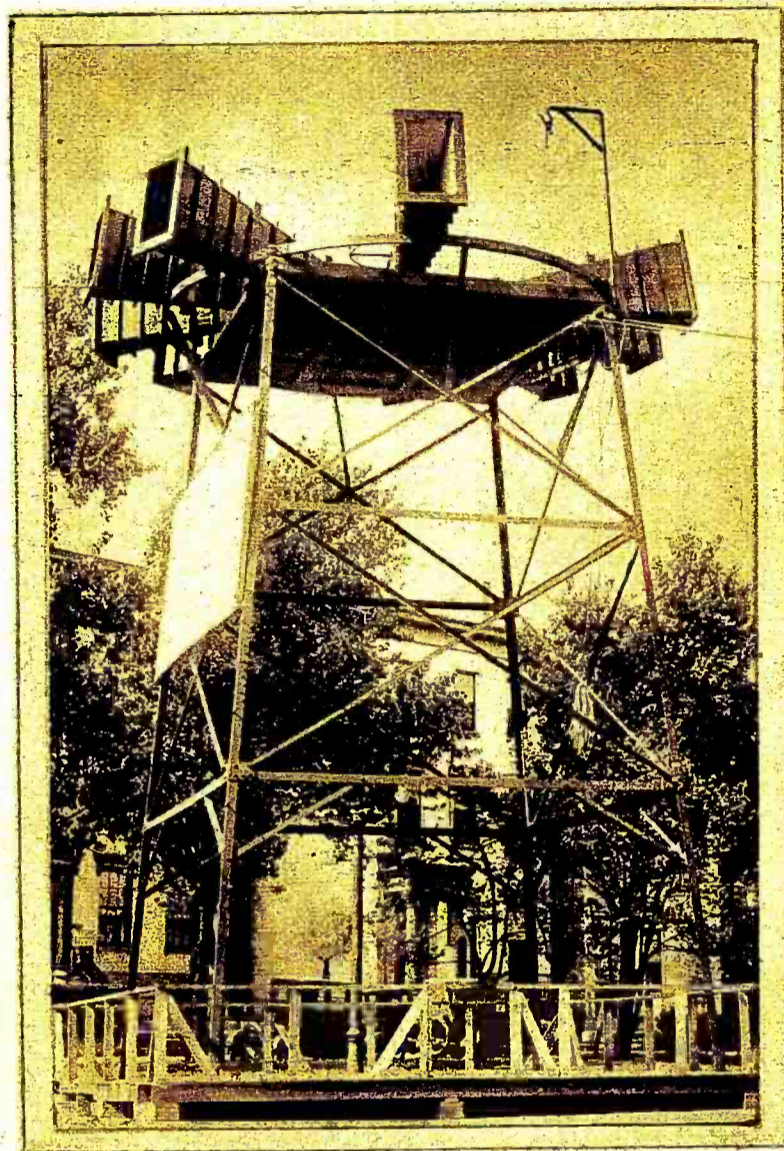

President Harding Delivering His Address at the Arlington National Cemetery on Decoration Day. His Voice Was Picked up by the Microphone Seen Above and Transmitted by Radio. His Speech Was Reproduced at Some Distant Points by Huge Amplifiers Similar to the One Shown at the Left.

Photos by U. & U.

PRESIDENT HARDING spoke to practically all the people of this country through the naval radio broadcasting service when he made his address at the Arlington National Cemetery on Decoration Day.

This was the first time that he had spoken over the radiophone, or that any Chief Ex-

ecutive has addressed so large a number of citizens. It officially opened the navy's dual broadcasting system, using two-wave lengths simultaneously.

At the amphitheatre wires connected the microphone, which was placed in front of the speaker, to the radio station at Arlington and to the Anacostia Air Station across the

Potomac. Arlington, NAA, transmitted the speech on a 2650-meter wave, and Anacostia, NOF, broadcasted on a 412-meter wave. By means of powerful amplifiers and huge horns, crowds of people at distant points heard the President's voice in unmistakable tones.

Motor Bus Equipped With Radio

By CHARLES GEIGER

BUS lines in California will soon be serving radio music with the rides! Should tests which the California Transit Company of Oakland, Calif., started recently prove successful, many of the 85 "White" buses operated by this line will be equipped with radiophones to pick up daily radio concerts in the bay region.

W. E. Travis, president of the California Transit Co., sent the first radio equipped bus out on its regular run to Sacramento a short while ago and in spite of the obstacles which confronted the test, enough information was obtained to warrant further experiments and to assure Mr. Travis that radio concerts would soon be a reality for his patrons.

With only a two-step radio short-wave receiving outfit and handicapped by the necessity of operating with a low antenna, the bus was able to pick up San Francisco and Oakland concerts as far as Martinez, and at Vacaville, the Gould broadcasting station at Stockton was heard.

At Sacramento a test was made by special arrangement with the Holbrecht broadcasting station. It was found that by a sacrifice of speed, the concert was as audible when the bus was in motion as when it was standing at the curb. At Stockton this experiment was repeated; people standing on the streets could clearly hear the music as it was amplified by the Magnovox attachment.

The Travis installation was made on the instrument board of the bus, so that the driver could "tune in" without leaving the wheel. The antenna was supported on uprights, which were securely braced to stand the vibration it is subjected to while in motion.

According to officials of the bus company and radio men interested in the tests from a scientific angle, some few refinements are still to be made, and larger instruments will be installed; a radio frequency outfit and experiments will be continued until they get the desired result at varying speeds.

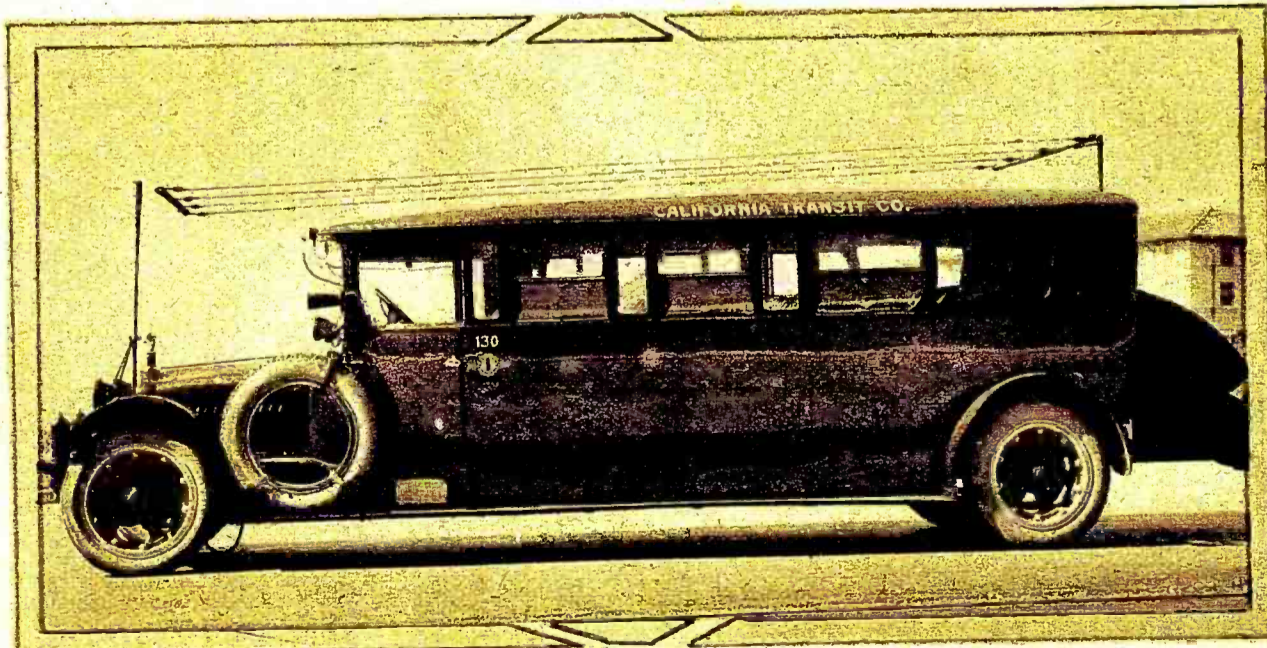

This Motor Bus Has Been Equipped with Radio to Entertain the Passengers While Travelling. Improvements Are to Be Made and More Cars Equipped.

The New York Radio Exhibition

Held at the 71st Regiment Armory



Things are Not Always What They Seem, so Don't be Alarmed if a Table Lamp or a Lady's Necklace Starts to Sing! It's Only a Radio Set.



This Unique and Compact Receiver Made an Excellent Showing at the New York Radio Show. Reception was Accomplished with a Loop.

RADIO shows follow each other in rapid succession. Like ships that pass in the night, some go by unnoticed. They perhaps cause a little stir in their immediate vicinity, but others succeed in making a considerably larger splash. The exhibition recently held at the 71st Regiment Armory, New York City, was of the latter variety. Radio enthusiasts of Greater New

York awaited its opening with impatience. Great things and new wonders had been promised. They were not disappointed. The show was undoubtedly the biggest and best. Of its priority in size there was certainly no question. The enormous floor space of the 71st Armory was entirely occupied by booths. In the center of the hall, the Regiment band rendered musical selections to

supplement the efforts of the artists at WJZ as reproduced by the innumerable loud-speakers. Moving pictures illustrating the principles of radio were constantly shown on a large screen. Wide passage-ways between the rows of spacious and well-arranged booths permitted the crowds to
(Continued on page 355)

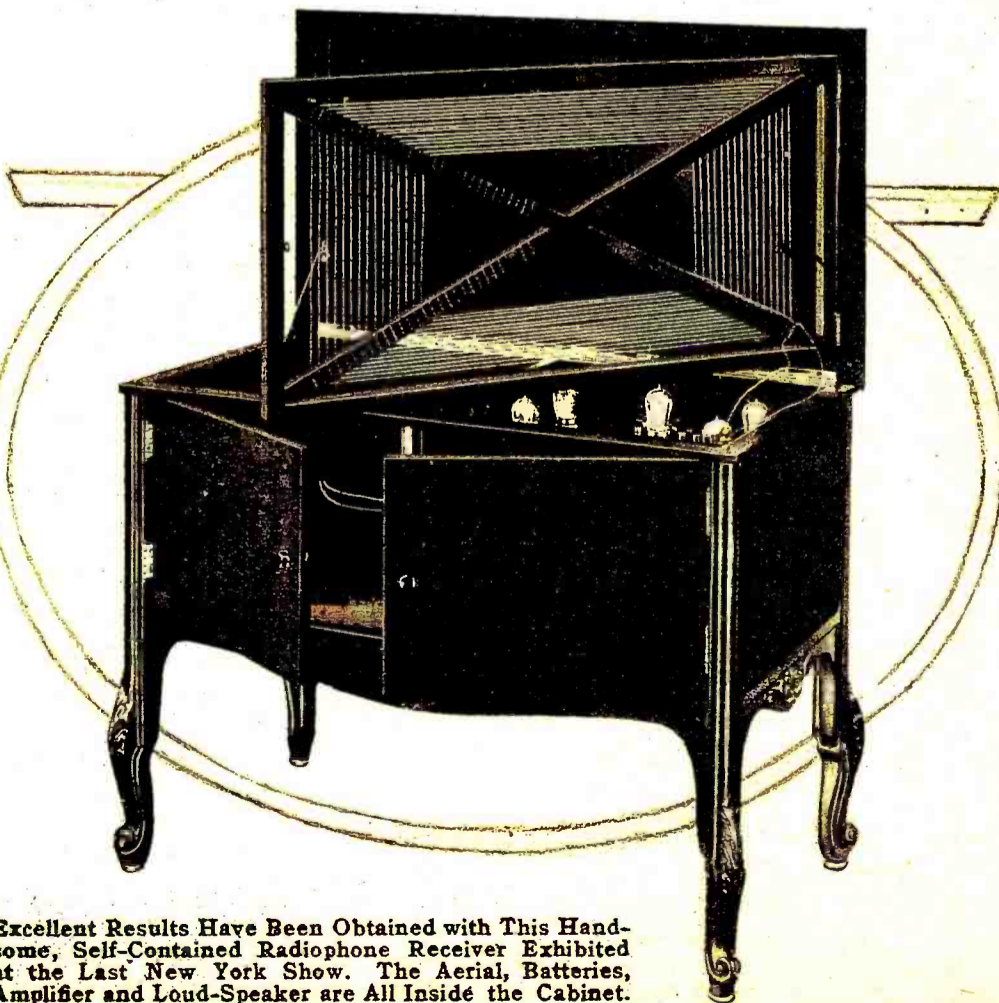

Excellent Results Have Been Obtained with This Handsome, Self-Contained Radiophone Receiver Exhibited at the Last New York Show. The Aerial, Batteries, Amplifier and Loud-Speaker are All Inside the Cabinet.

The Bogeyman of Radio

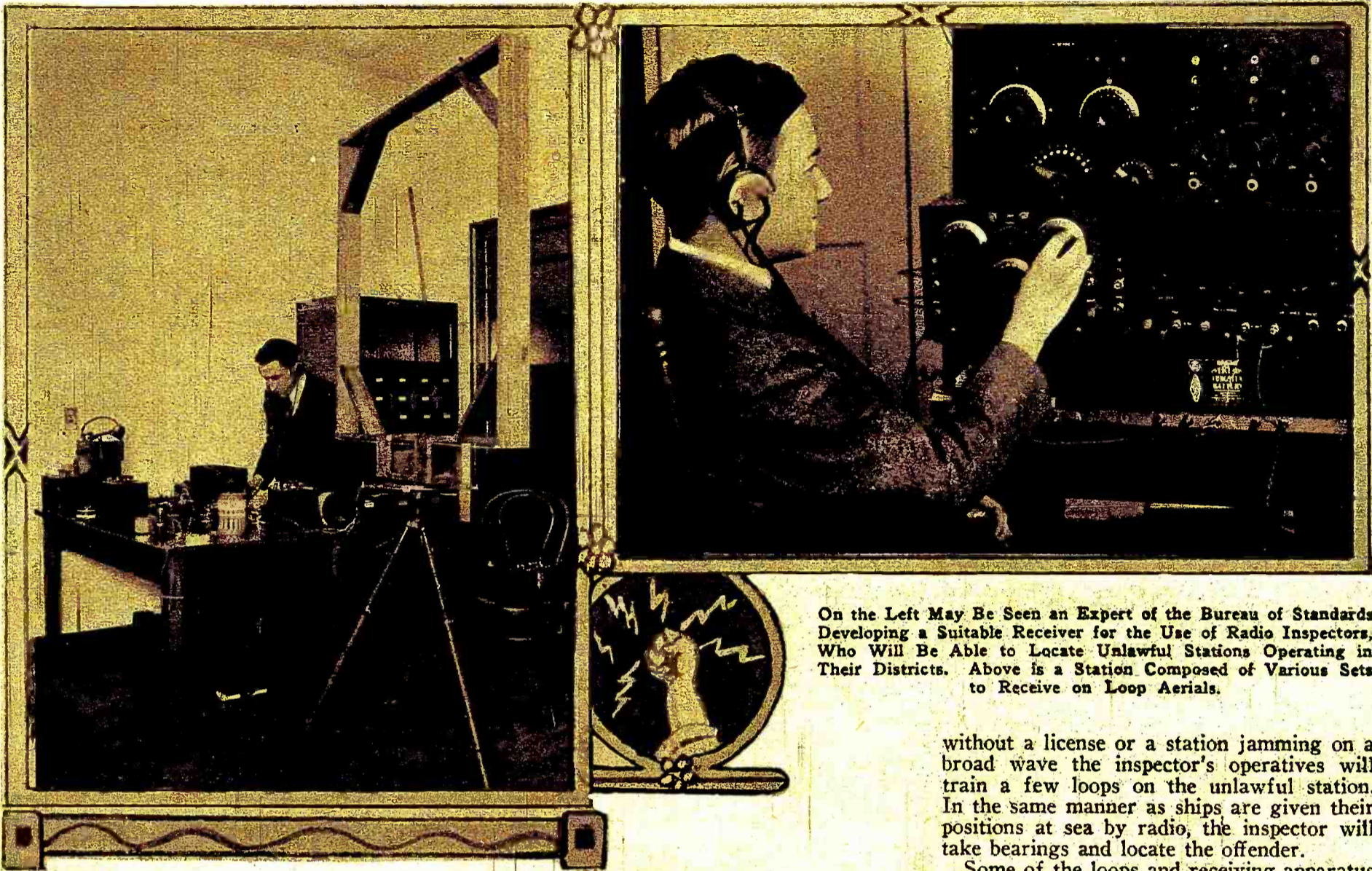

On the Left May Be Seen an Expert of the Bureau of Standards Developing a Suitable Receiver for the Use of Radio Inspectors, Who Will Be Able to Locate Unlawful Stations Operating in Their Districts. Above is a Station Composed of Various Sets to Receive on Loop Aerials.

WE probably all remember that strange, mythical character, "The Bogeyman," who exerted such a powerful influence over our behavior in our younger days. We were told to be good or the Bogeyman would get us. The threat rarely failed to improve our conduct, temporarily at least. It was the very aloofness of the Bogeyman that made us fear him. He never showed himself and we didn't know where he lived, but he was there all the time, watching us. One day he might "get" us. Just what that might possibly mean we didn't dare to think.

There is another Bogeyman in the land today. He, too, is watching all the time and he is looking for the bad boys of radio. He may be up on the roof or around the corner. He may be looking for the boy who jammed the ether with a spark coil from a thousand meters down to zero the night before, or the boy who was signing "George" and transmitting without a license. If he is looking for them he will find them. When he finds them he will "get" them and get them good.

The Bogeyman of

Radio is no myth, however. He is a decidedly material personality and is otherwise known as the Radio Inspector.

All over the country the radio inspectors for the various districts are to be supplied with loops and special receivers. When a report is received of a station operating

without a license or a station jamming on a broad wave the inspector's operatives will train a few loops on the unlawful station. In the same manner as ships are given their positions at sea by radio, the inspector will take bearings and locate the offender.

Some of the loops and receiving apparatus which the inspector will use are illustrated on this page. These loops possess directional properties in the reception of radio waves. The direction in which any transmitting station lies may be quite closely determined. While the offending station is transmitting, bearings are taken in this manner from two or three widely separated locations. Bearings are

drawn on a chart of the district and should all cross at one point. This point indicates the position of the sending station.

When the approximate position is thus determined, the loops and receivers can be taken to the proximity of the station and more accurate bearings taken. Gradually the hand of the law closes down on the offender until his aerial is spotted.

The least penalty which the boy with the broad wave length may expect to receive is a neat little printed form advising him that his license has been suspended. If he continues to break the law it will be cancelled. There are other and more severe penalties for those who operate transmitting stations without a license.

Look out, or the Bogeyman of Radio will get you!

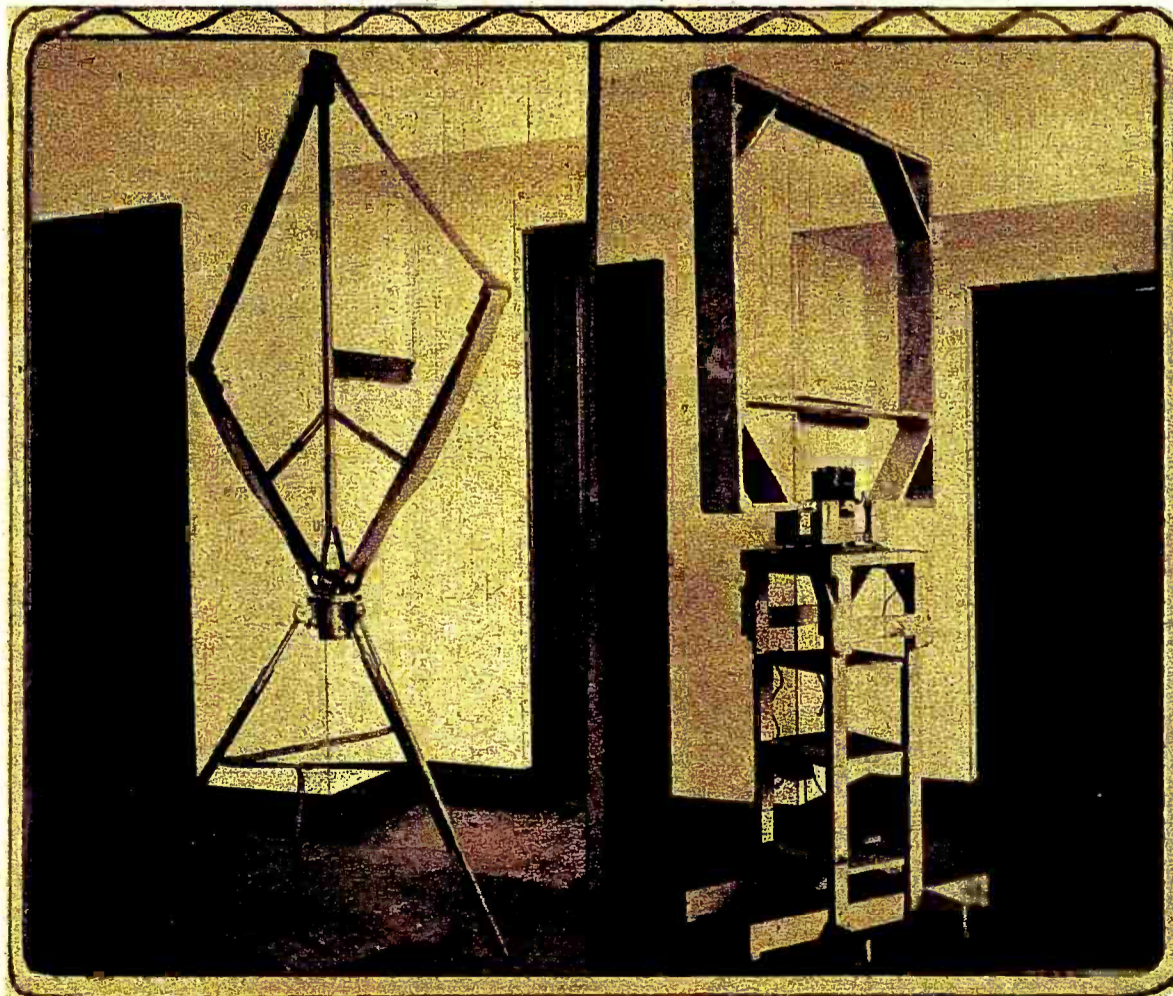

Two Types of Loops Being Used by Radio Inspectors to Locate Unlicensed Stations Which Jam the Ether, with Untuned Transmitting Sets.

Photos by U. & U.

Multiple Wave-Lengths to Improve Broadcasting

By H. WINFIELD SECOR

IF you are a radiophone broadcast enthusiast, and particularly if you have been using a loud talker in connection with your radio receiving set, you have no doubt noticed the fact that, contrary to your expectations, a brass band did not give any greater volume of sound from your loud talker apparently, than when a single number was played or sung. Furthermore, you have noted the fact, no doubt, that when a number of instruments were played, as well as when several people sang together, the results were not always very satisfactory. One of the principal reasons for this difficulty in radiophone broadcast reception seems, from the writer's observations, to be due to the fact that the single diaphragm of the loud talker cannot properly respond to all of the various vibrations and different notes, which are being sounded simultaneously when a group of people sing or play.

Some time ago one of the leading manufacturers of loud speakers was called upon to install several of these instruments in a large dance pavilion in a California city, and excellent results were obtained by using separate circuits for transmitting and reproducing, telephonically, the music from each instrument in the orchestra. For instance, there was a microphone assigned to the piano, the saxophone, the violin, the trombone, etc., and each of these microphone circuits was connected to its own loud talker placed in a distant part of the dance pavilion,

each loud talker therefore reproducing the music from one of the instruments only. It is readily seen from this description that when all the loud talkers were actuated by their respective microphones, a harmonious flow of music ensued.

The diaphragm of a telephone receiver, which forms the basis of practically all loud talkers, is limited to the number and form of vibrations to which it can respond at one time. Of course, it will attempt to give some sort of reproduction of all the sounds impressed upon the microphone connected with it, the same as all phonographs do, but experience shows that the ordinary loud talker does not give the results that one might expect,

when it comes to reproducing band music, to mention but one example.

Bearing in mind some of the earlier radio experiments carried out by Dr. Marconi, in which three or more radio messages coming from different stations on different wave-lengths, were picked up on the same antenna and caused to record in dots and dashes on their respective tape registers, each detector being connected with its own tuning inductances and condensers for adjustment to the respective wave-length, such a multiple wave-length transmitting and receiving scheme might well be applied to radiophone broadcasting.

(Continued on page 308)

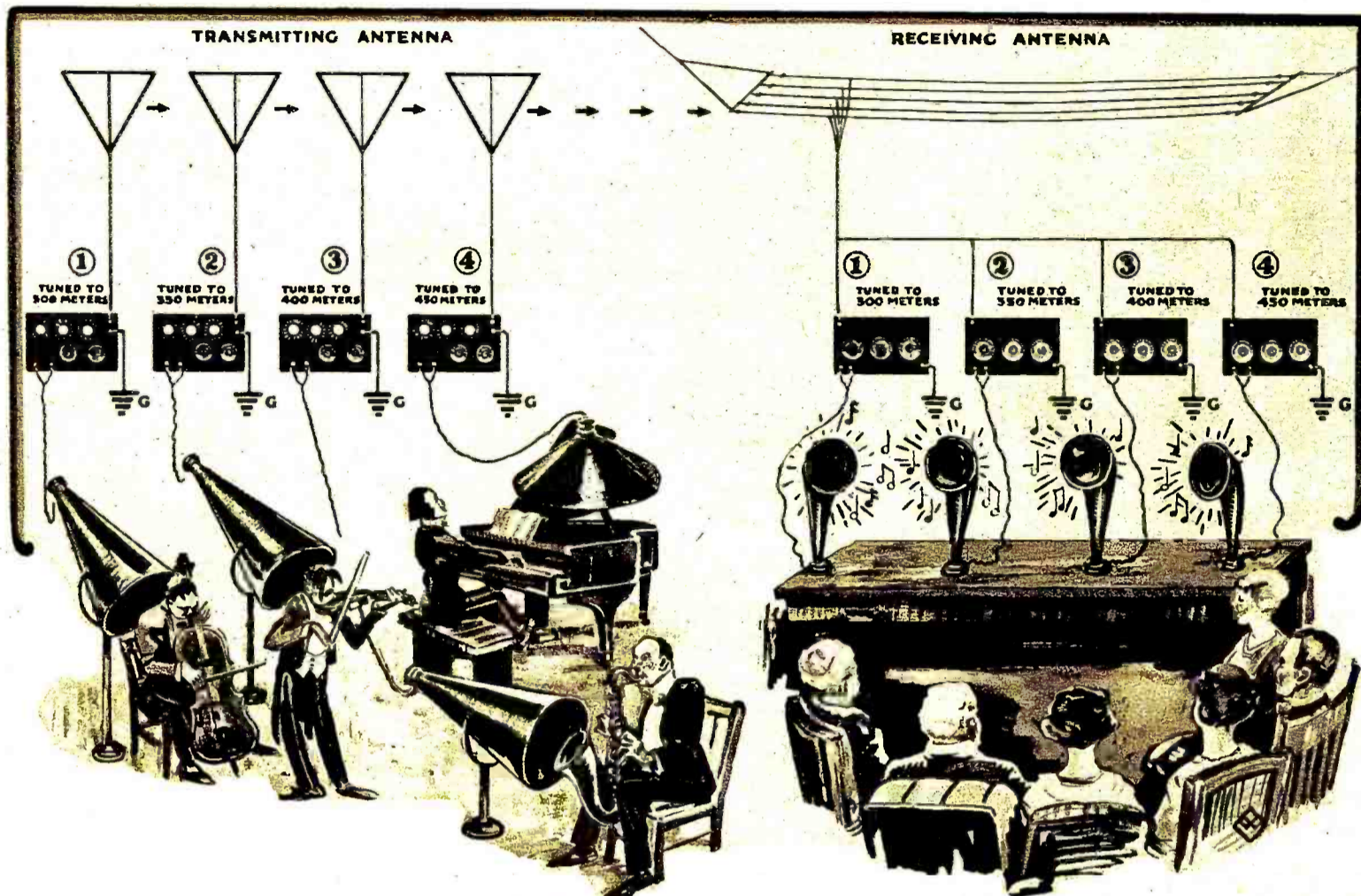

By the Use of Separate Sets for the Broadcasting of Music Much Clearer Tones Would Be Obtained, As Each Microphone and Loud Speaker Would Reproduce the Music From Only One Instrument; This Method Has Proved Successful On Wire Transmission.

The World's Largest Radio Horn

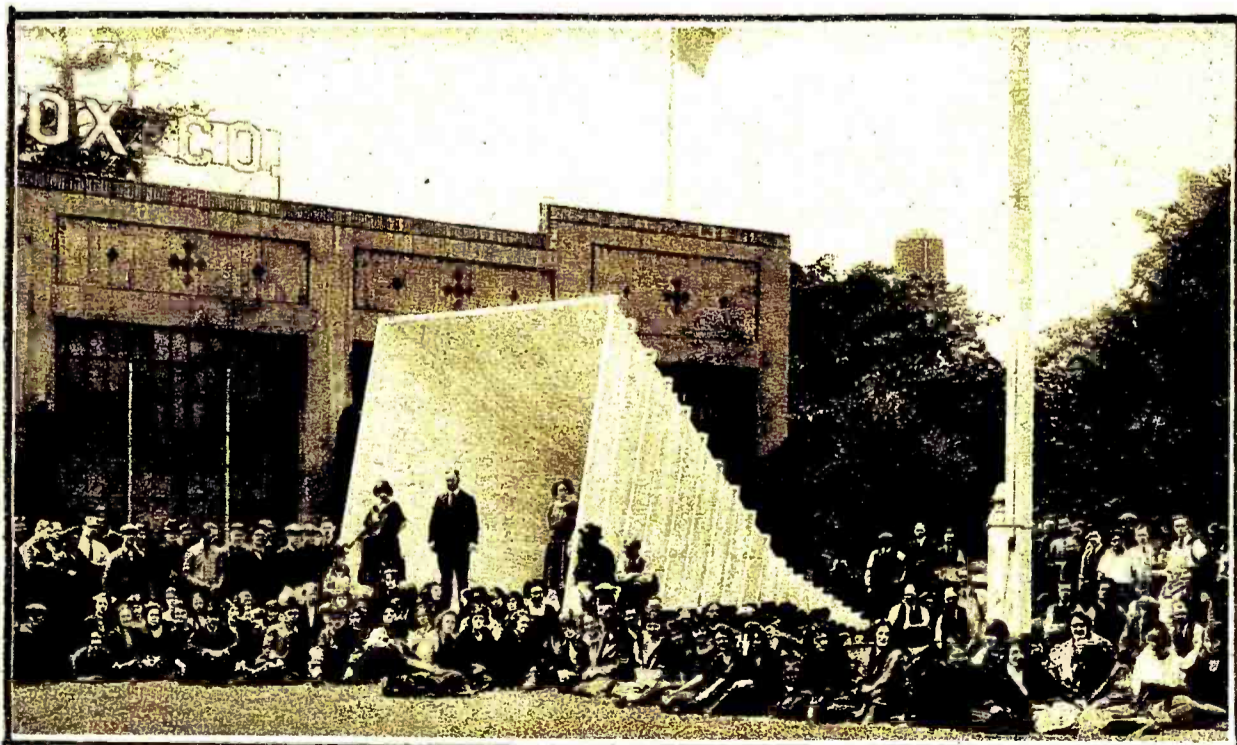

Thanks to This Horn, Which Is Adapted to An Extraordinarily Powerful Reproducer, Music May Be Heard Over an Area of About 29 Square Miles.

IDORA PARK, a public amusement resort in California, boasts possession of the world's largest horn. Measuring 35' in length, with an opening 12' square, this horn was recently installed for broadcasting music received by radio, and is in successful daily operation at the present time.

Equipped with the Magnavox radio reproducer and also the Magnavox power amplifier, the broadcasting capacity of this gigantic instrument is sufficient to carry radio music throughout an area of approximately 29 square miles. One thousand feet of clear aeroplane spruce lumber went into its construction, which incidentally presented a number of interesting problems to the engineers by whom it was designed and built.

Of absorbing interest first of all on account of its sheer size and amplifying range (so much greater than any previous horn), this instrument, installed in Idora Park, also appeals to the imagination as being in all probability only the first of its kind. A spectacular "stunt" on the part of an enterprising amusement resort, the basic idea is capable of really impressive development. It is a further indication of the far-reaching

(Continued on page 310)

The Newspapers' Part in Radio Development

By ROSCOE SMITH



The Display of Apparatus Made by Amateurs Who Were Awarded Prizes in a Newspaper Contest.

RADIO has become a very practical business in Chicago. High school students are not only studying its theories and principles, but making apparatus as well. Radio equipment on display at the *Chicago American* Radio Show, ranging from the finest regenerative set with two-stage amplification, capable of receiving at a distance of 1,200 miles, down to the simplest outfit a boy can make for \$1, is the product of the Austin High School, Lane Technical High School and the Tilden High School workshops.

The big attraction of the Tilden exhibit was the 20-watt radio telephone transmitter, flanked by the other apparatus completing radio transmission. The transmitter has a sending radius of 200 miles under good condi-

tions, carrying voice and music. A motor generator of 100 watts, wound by Tilden students, a 500 cycle transformer supplying the plate voltage for the four tubes when the set is used as a modulated C.W. set and a filter coil, also attracted much attention. Three radio receiving sets, the largest being a variometer regenerative set made by Frank Smolek, a 2B student, a Reinartz tuner with single current spider web inductance and tickler feed back gave evidence of Austin High's activity in the field of manufacture.

Ever since RADIO NEWS published the account of "Opera Broadcasting at Chicago" in February, when it became a practical reality, radio development in Chicago has been a succession of daily surprises, with new angles confronting the "fans" at every turn.

When opera broadcasting was given publicity and the public realized that wireless telephony had come to them overnight, so to speak, the first questions asked were, "What are the best radio sets?" "What do they cost?" "Where can we get them?" Everybody was "at sea" and none so badly waterlogged as the radio craft itself!

Then the newspapers came to the rescue. Radio pages, radio supplements, and radio columns began to appear. Concert programs were printed, market schedules and news broadcasted by various newspapers from the Westinghouse station. Clergymen broadcasted sermons, Sunday evening concerts became popular and Mayor Hylan, Anne Morgan and other celebrities gave special talks.

(Continued on page 326)

Radiophone Broadcasting Station Installed by Texas Newspaper

THE Fort Worth (Texas) *Record* is the pioneer newspaper in the radio field in the Southwest. It is the first paper west of the Mississippi to install its own radiophone broadcasting station. The set is of 200-watt input, with a range of from one to two thousand miles, and is used for broadcasting weather forecasts, crop and market reports, baseball scores, police bulletins, concerts, etc.

The set was purchased through a Fort Worth firm and all work on it was done by

A Texas Newspaper Station Broadcasting Entertainment and Weather Reports.

the *Record's* staff. It is located on the roof of the *Record's* five-story building, where remodeled windmill towers are used to carry the antenna 125' above the ground. The station is regularly licensed by the Government for broadcasting, and has been assigned the call letters WPA and wave-lengths of 360 meters for broadcasts and 485 meters for weather forecasts.

This station is in charge of a licensed operator, W. H. Pitkin, an ex-Navy man, who has been in the wireless game for a number of years.

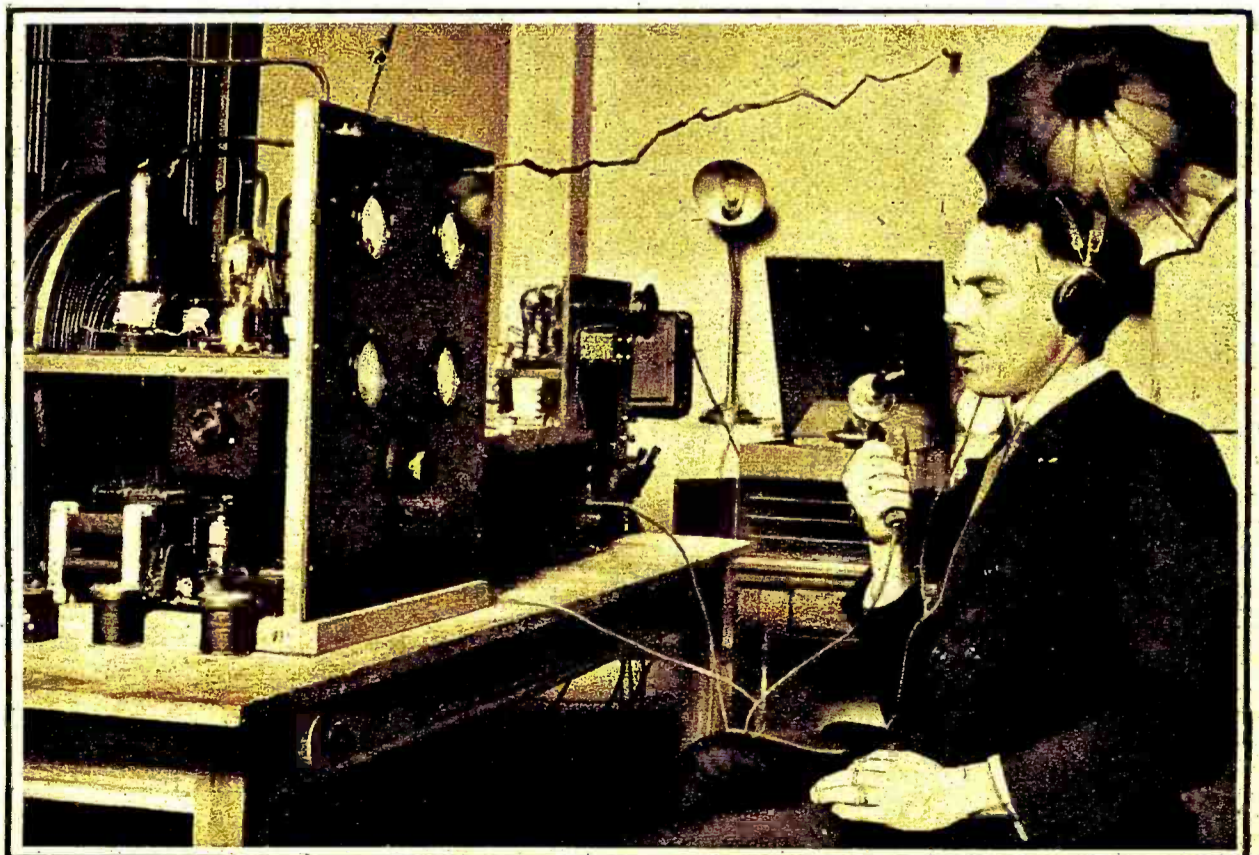

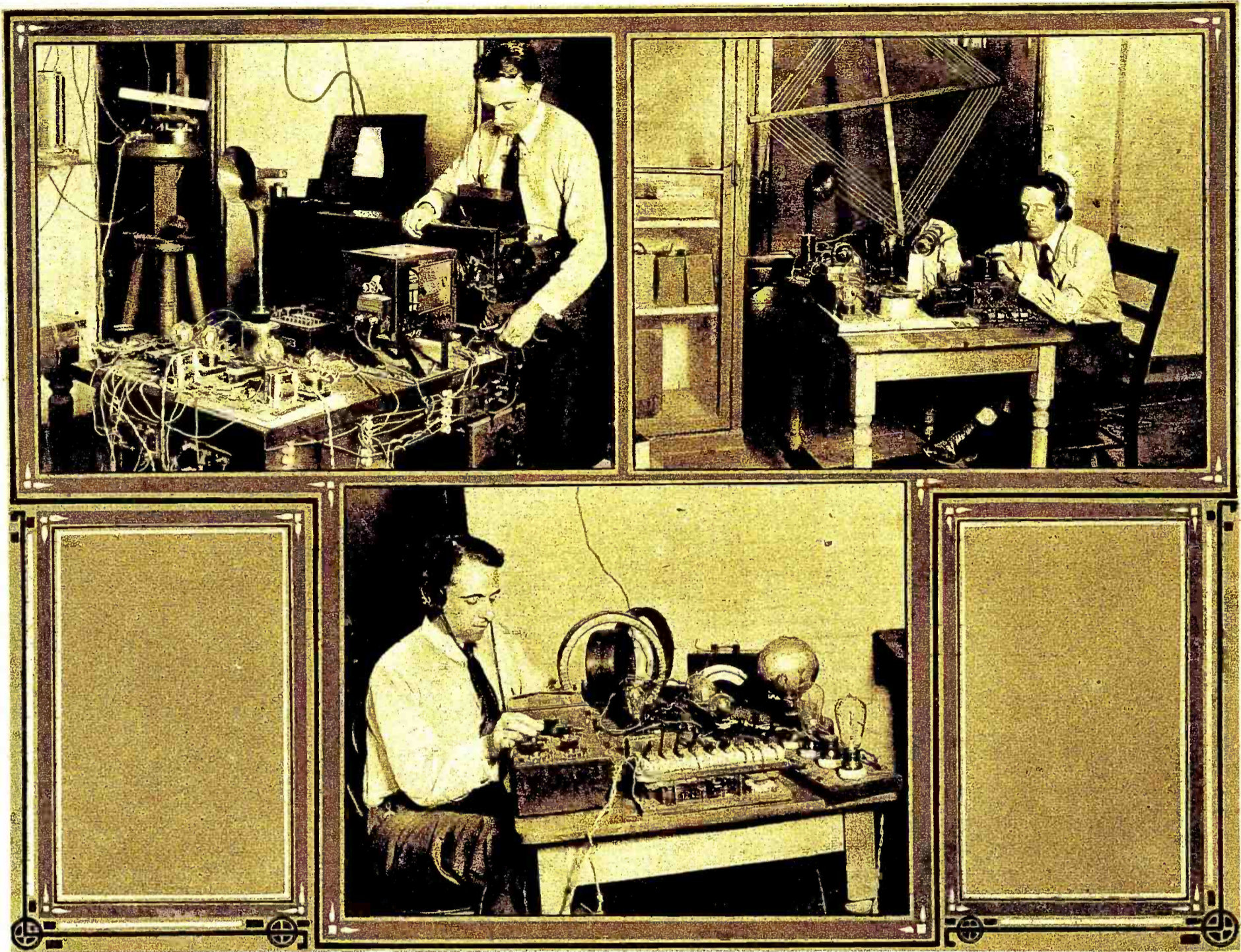

Photos by K. & H.

One of the Latest Developments of the Radio Laboratories of Columbia University is the Set Shown Above (Center), with Which Reception May be Effected without Batteries of Any Description. Ordinary House Lighting A. C. is Used to Supply the Filament and Plate Currents. The Circuit is so Arranged that the Hum of the A. C. is Avoided. The Left-Hand View Shows One of the Electrical Engineers of the College Testing the Circuit with an Oscillograph to Determine Whether Proper Rectification of the A. C. is Being Accomplished. The Right Hand Photograph Shows the Circuit Being Tested Under Actual Operating Conditions, Signals are Being Received, Using a Loop Aerial. The Circuit is Particularly Adapted for Radio Frequency Amplification.

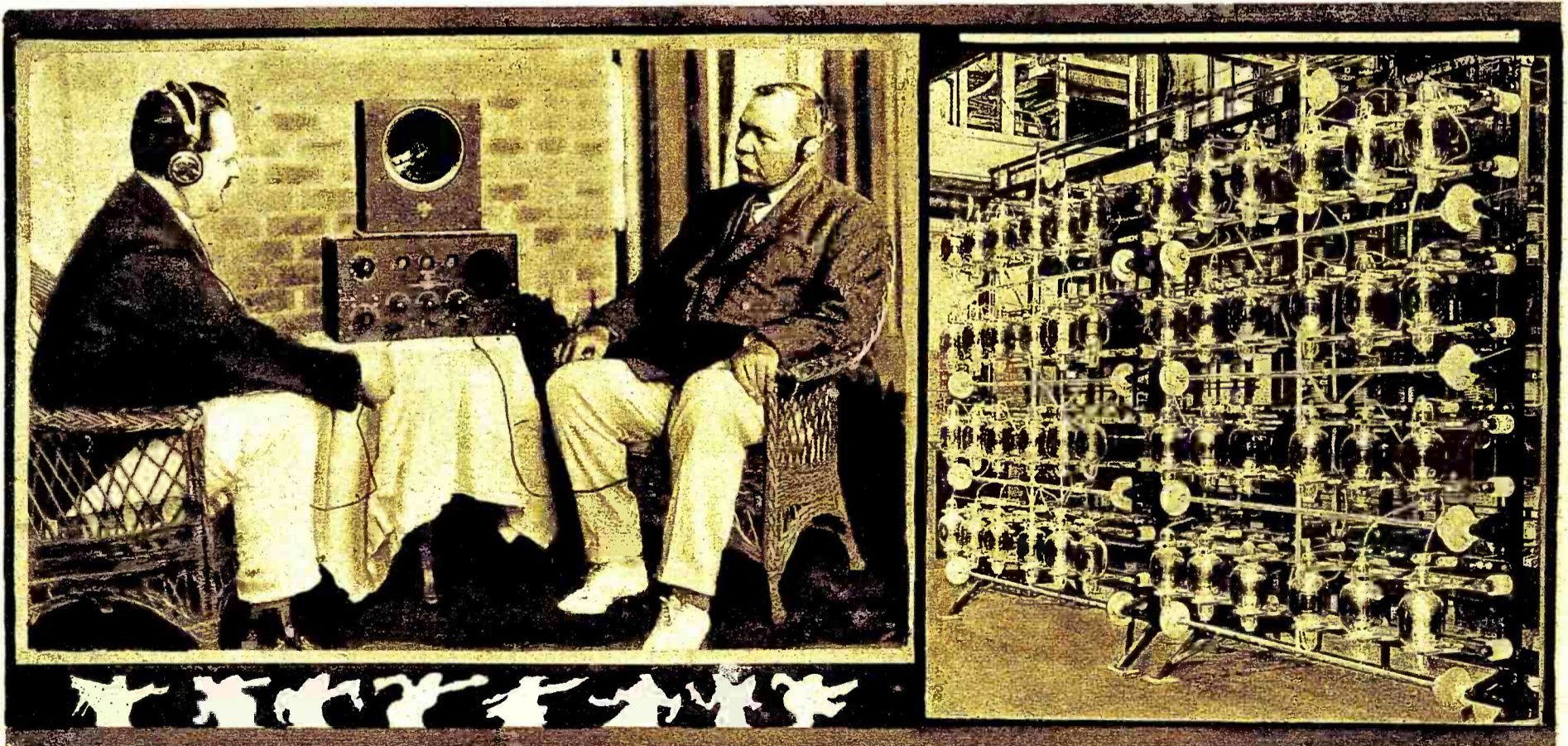

Sir Arthur Conan Doyle Has Announced His Intention of Studying the Mysteries of Wireless in an Effort to Apply it to His Psychic Investigations. After Listening to the Daily Broadcasting from the Newark and Pittsburgh Stations, the Great English Novelist and Spiritist Displayed Such Unusual Interest that He Made Arrangements to Have a Complete Radio Outfit Sent to His Home in England, and this Will be Installed Immediately After Sir Arthur's Arrival There.
©Keystone

View of the Valve Station Used at Carnarvon, Wales, for Direct Transmission to Australia in November and December last. This Station, with 48 Transmitting Valves, is the Most Powerful Valve Transmitter in the World. Since this Photograph was Taken the Number of Valves has been Increased to 56, Each Valve Being About the Size of a Football.

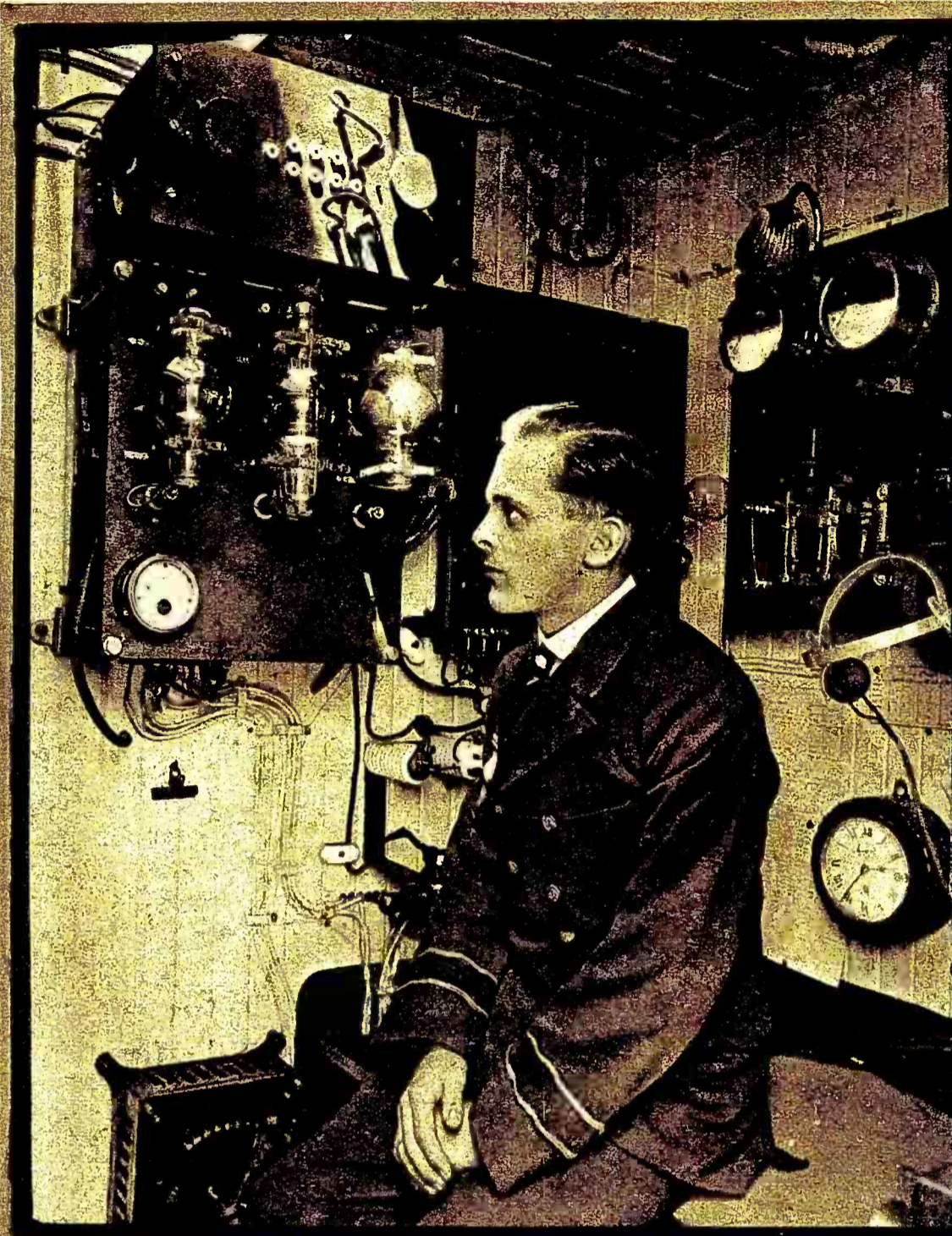

© U. & U.

Guglielmo Marconi, the Famous Inventor, Who Recently Arrived in this Country on Board His Yacht Electra. Mr. Marconi Delivered an Address Before the Institute of Radio Engineers in Which He Propounded a New System of Directional Wireless Telegraphy on Short Wave Lengths.

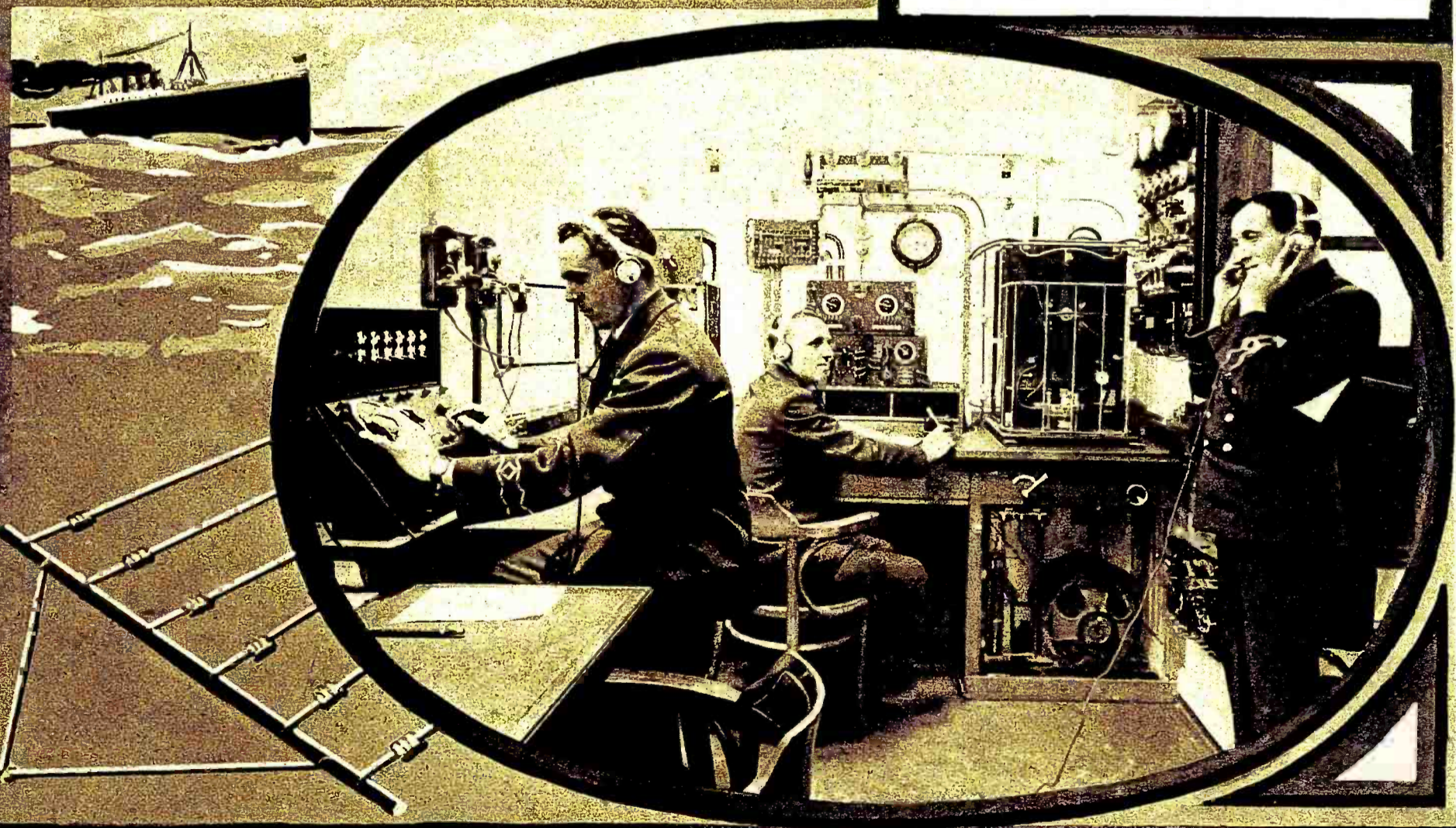

Two Views of the Up-To-Date Ship Stations of the British Marconi Company. The Upper Photo Shows the Type of Valve Transmitter Which is Now Being Used to Keep in Constant Communication With Shore From Mid-Ocean. Lower Photo is of the Well-Appointed Radio Room on Board the Majestic, the Largest Ship in the World. To the Left of the Photo is the Radio Compass Receiver and, in the Center, the Main Operating Table With Tube and Spark Transmitters.

Photos by Galloway

A Hill Billy's Radio

By MONROE WORTHINGTON



I Constructed an Electromagnet and Put It in Series With the Receiver, Which Would Not Sound, Due to the Weakness of the Currents. I Purchased a Large Drum and Drumsticks of Laminated Iron, and Hinged Them So That the Pull of the Electromagnet Would Cause the Drumsticks to Strike the Drum, and Thus Reproduce the Signals.

IT has taken some time for Radio to penetrate to the hills. I live in the eighth district among the 'shiners, strikers, static and "snakes." Now that it has started, the four hundred burn the midnight oil and burn out audion bulbs, listening to Arlington, Nauen, Paris, and the other broadcasting stations. I am going to broadcast some of my experiences to an eager AUDIENCE, in hopes that they will keep another good man from going wrong.

When we made our yearly visit to town, I took along a lot of coonskins, sold them, and had some money to spend on a Radio set. I bought a cheap phonograph for \$150 to use as a cabinet, for I knew that I must economize, and besides, a radio set is enjoyed so much more when it is disguised as a phonograph, or a toy wagon, or a kitchen range. I found that regular Radiotron bulbs were too expensive, and so bought a 40-watt Mazda bulb. The dealer said that the best bulbs come from Holland, but I must procure them from a seed company, for they did not handle that line. I learned that they must have good ground, and so I decided that I could not use them, for our soil is of a poor variety of cou-loam (Coulomb) and we can raise only cane on it. When I priced alphabetic batteries, I found that the CHARGE was too high. The salesman said "WATTS fifty dollars?" but my brain was not SENSITIVE to his reasoning. I also bought some phonograph records, for the most advanced amateurs say it is well to keep records.

I planned to build a universal regenerative-superheterodyne seven-stage radio frequency and four-stage audio frequency, with a loud speaker. I forgot to buy a bakelite panel, so I used 16 gauge galvanized iron. I found that this was a very good conductor, was

easy to machine, and served the purpose excellently. I planned to have a crystal detector for use when my alphabetical batteries ran down—this was in the mountains, remember, do not be surprised to hear that they ran down. I tried to get some cat whiskers from old Tom, but the fool cat did not like to sacrifice his beard in the interests of science, and he filled the eighth district with inharmonics of undamped amplitude. I could never understand, when the sound waves were so evidently undamped, why the neighbors talked about "That DAMPED cat."

I had a lot of trouble in graining my panel. My father said that wheat was too expensive, and our oats crop was a failure. The lowly moonshiner thrives in our country, and I got some corn whiskey from one of them. He said it was the only kind of GRAIN alcohol he had on hand. I applied it to my sheet iron panel with a brush, and the results were highly satisfactory. It is necessary, however, that the alcohol be wiped off quickly; for if it is left on, it will eat up the panel.

All the copper in our country is used in the construction of stills—Not the Hollywood, cinematographic variety, but the kind used in the soft drink business—and I was puzzled, trying to get material to make an aerial. I finally built it of WIREGRASS, which thrives in our country. I filled my variable condensers with water. During the winter the water freezes, and I use them as fixed condensers.

There is a river near our home, and therefore, I found it necessary to use BRIDGING condensers. At first I used the suspension type, but I found that when the wind blew, it caused swinging of signals, and I now use the cantilever type with great success.

The next problem was to provide the current to operate the filament and the plate. We have currants right on our farm, but they ripen only in the summer, and I wanted to operate all the year. Here was where my phonograph came in handy. I placed permanent magnets on the periphery of the Rotor of the phonograph. Then I placed COILS about it. The coils, by INDUCTION function as accumulators, and their capacity is one quart, dry measure.

And this brings up one of the most important things in building a set. The material of which a plate is built affects the results to a great extent. I used successively Sévres, Haviland, and Delft China, and later, Chippendale and Heppelwhite and electroplates, finished in mahogany. At present I am using copperplates, engraved in ChromoTONES. This makes my tubes very artistic and musical. In fact, I call one of them my WHISTLER.

As soon as I got the set assembled, I invited all the neighbors to come and watch the time signals come in. When they first came in, Miss Ethyl Alcohol, daughter of the local Liquor Magnate (magnet) fainted, and several of the other women HOWLED and went into HYSTERESIS. I did not realize the importance of using a high aerial, and the next day, which was Monday, I noticed that the signals were highly DAMPED, that the language coming over the radio was highly COLORED and that the signals were FADING. I found that our laundrywoman had hung some WET clothes on the aerial, and this caused the damping. The clothes were COLORED, and the sun was causing the FADING. I decided then and there that I would have a higher aerial. I suspended it between two

(Continued on page 298)

WITH THE AMATEURS

THIS Department is open to all readers. It matters not whether subscribers or not. All photos are judged for best arrangement and efficiency of the apparatus, neatness of connections and general appearance. In order to increase the interest in this department, we make it a rule not to publish photographs of stations unaccompanied by a picture of the owner. We prefer dark photos to light ones. The prize winning pictures must be on prints not smaller than 5 x 7". We cannot reproduce pictures smaller than 3 1/4 x 3 1/4". All pictures must bear name and address written in ink on the back. A letter of not less than 100 words giving full description of the station, aerial equipment, etc., must accompany the pictures.

PRIZES: One first monthly prize of \$5.00 All other pictures published will be paid for at the rate of \$2.00.

R. M. Sherrill's Station 9AAV at Evanston, Ill. This Month's Prize Winner

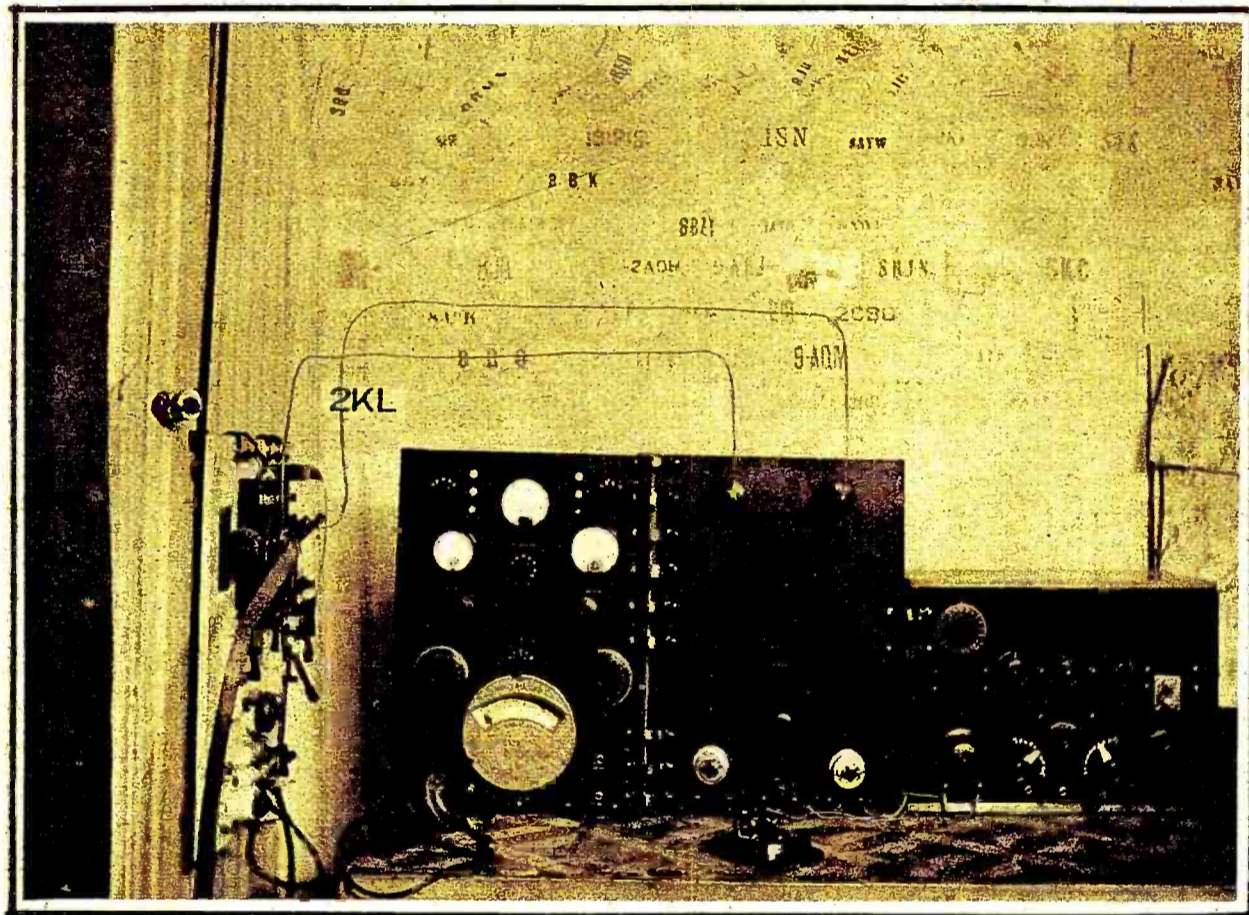

This One Is Entirely Home Made; It Looks Good and Works Well. Compliments for Your Station O.M.

THE aerial at station 9AAV is supported by two masts, the tops of which are 55' high. The antenna is a 2' cage consisting of eight wires 64' long. The "lead-in," which is attached at the center of the aerial, is also a cage, but it tapers from a 10" diameter near the top to a stranded cable at the lower end. The height of the antenna proper at the middle, which is its lowest point, is 50'. The ground system consists of water pipes, and of copper wires buried under ground beneath the antenna.

Practically all of the apparatus used, for both sending and receiving, is mounted on the three panels, as shown in the accompanying photograph. These panels, and as much of the apparatus as possible, are home-made. The first panel, from the left, is the C.W. transmitter, the center panel contains the filter and the controls for the transmitter, and the third panel contains the receiver.

The receiver is the usual regenerative, but with a two-step audio frequency amplifier mounted in the same cabinet. Binding posts on this panel make it possible to use the detector and amplifier with any other circuit if desired. The "B" batteries for this receiver are also home-made. They are of the Edison Storage Battery type, and similar to those described in RADIO NEWS of April, 1921. These batteries, which give a total of 96 volts when fully charged, have proven very satisfactory in over a year of service.

(Continued on page 320)

The Station of St. John's University, Collegeville, Minn.

THE radio station at St. John's University was begun in 1915 by Rev. H. Doerfler, O. S. B., the dean of physics. Since that time it has continued to progress.

The aerial is of the inverted "L" type and consists of five 7-strand No. 20 phosphor bronze wires, which are spaced 2' apart. The horizontal part is 60' long, 75' above the ground and is suspended from two steel towers 101' high. The old ground system was abandoned, in favor of the counterpoise, which insures a much sharper wave. This counterpoise is identical in dimensions with the flat top of the aerial, and hangs directly below it, about 18' above the ground.

The transmitter consists of a 110-volt A.C. motor-generator, supplied from the 220-volt D.C. mains of the University power house. On the shaft of the motor-generator is mounted the spark gap. By means of a shifting device the spark may be advanced or retarded, so as to bring it into synchronism with the A.C. generator.

The 1-K.W. "Coffin" transformer is placed directly below the motor-generator, while the

(Continued on page 320)

How do you like this little motor generator? 'Twould look good under our table, what do you think? Note the aerial switch arrangement, it is controlled by the S. P. switch on the table.

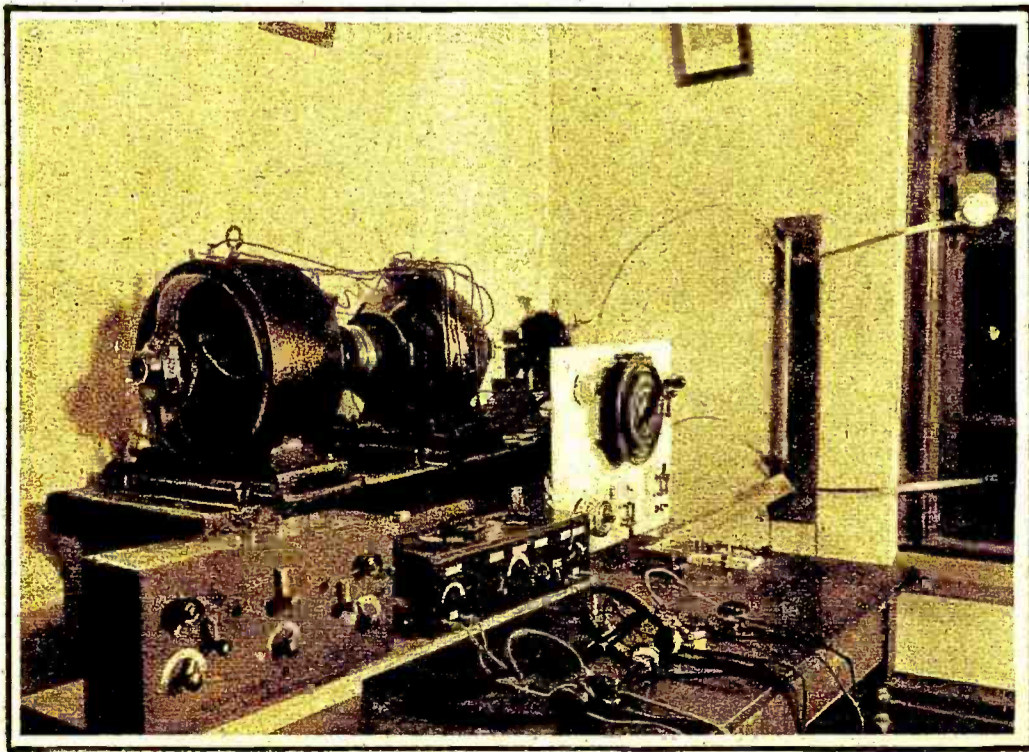

Charles Reed's Station 3BRI, at Harrisburg, Pa.

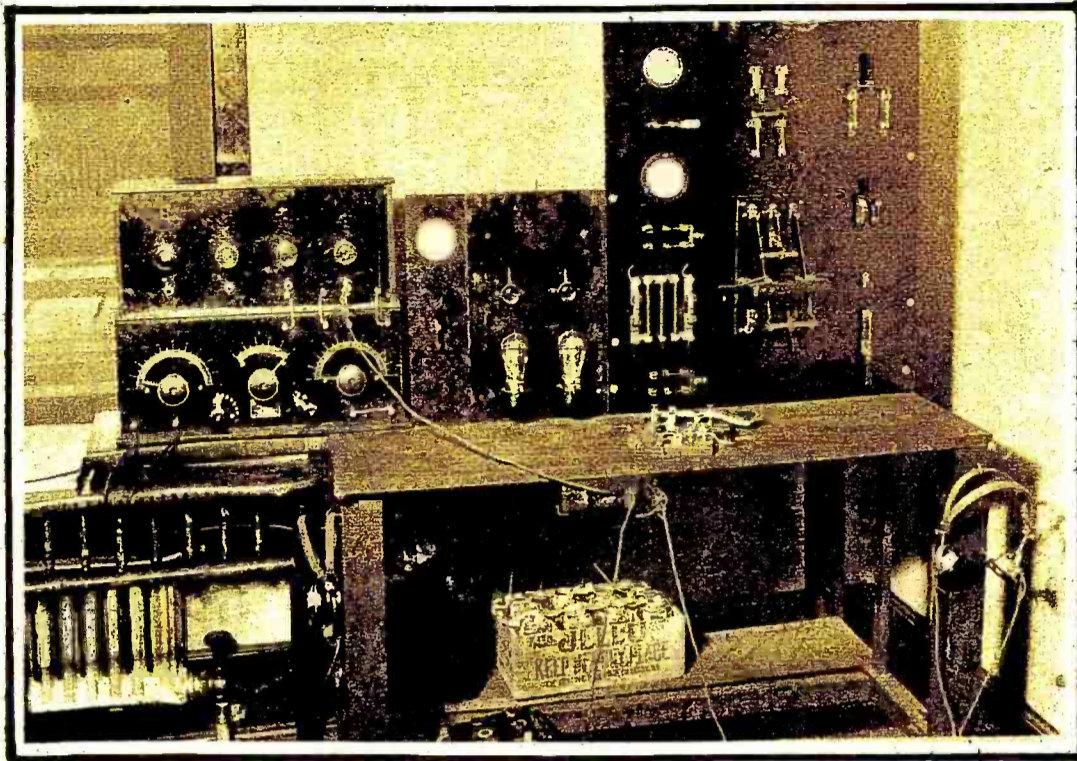

A Good Amateur Station Built by the Owner. We Wish Him a C.W. Set as Big as His Spark Panel Transmitter and Inversely. Let Us See Your Set When It is Changed OM.

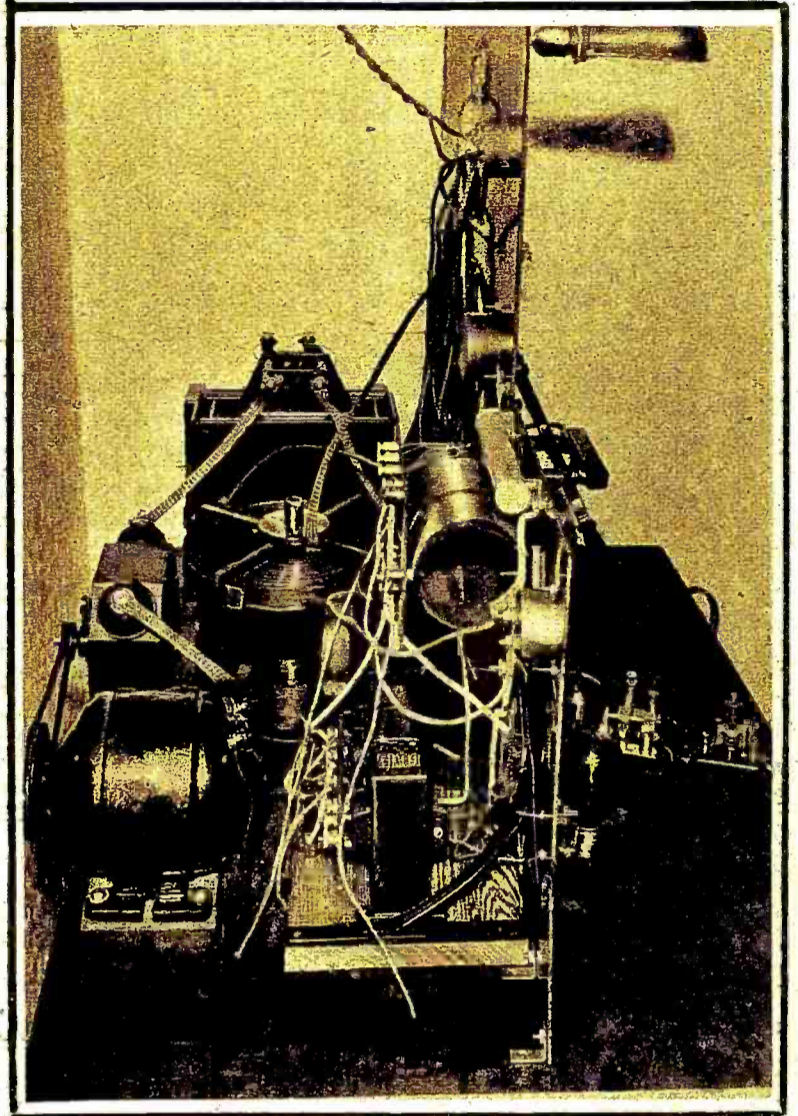

HEREWITH are two photos of my outfit located in Harrisburg, Pa., call letters 3BRI. This consists of a 1-K.W. spark set and 10 watts C.W.

My spark set is composed of a 1-K.W. Acme transformer, a Thordarson oil immersed condenser, a Benwood rotary, a pancake O.T. and Westinghouse motor. The antenna switch and change-over switches may be seen mounted on the large panel, all changes being controlled from it; I also have kick-back preventers mounted and equipped with 10-ampere fuses, while the main at the top of the board is equipped with 30-ampere fuses.

My C.W. set is not quite complete, as I am going to add 10 more watts to it. My transformer is an Acme C.N. and Tusca in-

ductance, and I must say that for getting out this little set has it all over the 1-K.W. outfit. On 10 watts I am radiating 2½ amperes.

The Jello-box under the table, while not very good-looking, is a very efficient electrolytic rectifier consisting of eight jars, containing lead and aluminum strips immersed in borax and distilled water. Although this rectifier makes a little hum while operating, it sure does do the work. My receiver is a Zenith tuner and a home-made detector and three-step amplifier, using Radio Corporation transformers. I had to set it in line with my panels in order to take a picture; ordinarily, I have it placed at

right angles to my large table, but I could not snap it in that position. The transformer and receiving apparatus are directly under my antenna, which is 70' long and 65' high, consisting of four wires spaced 3' apart, and is of the inverted "L" type.

I would like to have a card from anyone hearing me.

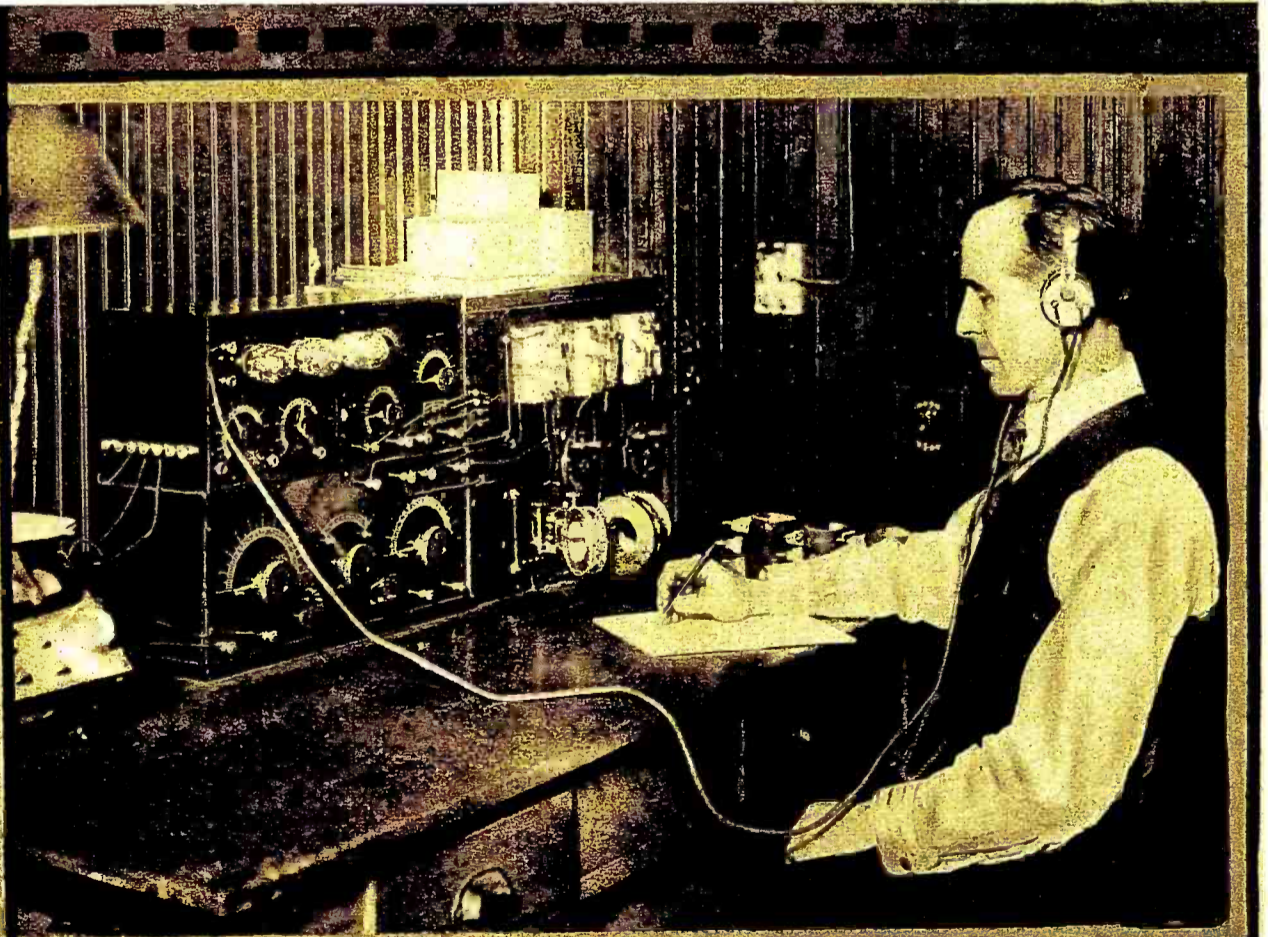

Left: A Walking Cane Containing a Telescopic Fishing Rod and a Complete Receiving Set With a Range From 200 to 1400 Meters, is Owned by a Seattle Radio Enthusiast. The Coils in the Set Are Made With 1000 Feet of Fine Wire. An Unusual Idea is the Telephone Receiver Attached to the End of the Cane.

Above: A View of One of the Stations Installed for Experimental Tests in Radio Communication With Moving Trains.. Successful and Constant Communication Was Established and Radio is Being Used in Some Locations in the Dispatch of Trains.

© K. & H.

© Keystone

Music and speech are received through this ordinary shell with remarkable clarity of tone. The idea was first adopted by Father Odenbach, director of St. Ignatius College observatory, whose station is shown in the photograph. The tip of the shell is ground off and an opening chiselled out at the lower end. Amateurs should now be able to put to a useful purpose the shell which has been reposing on the mantel-piece.

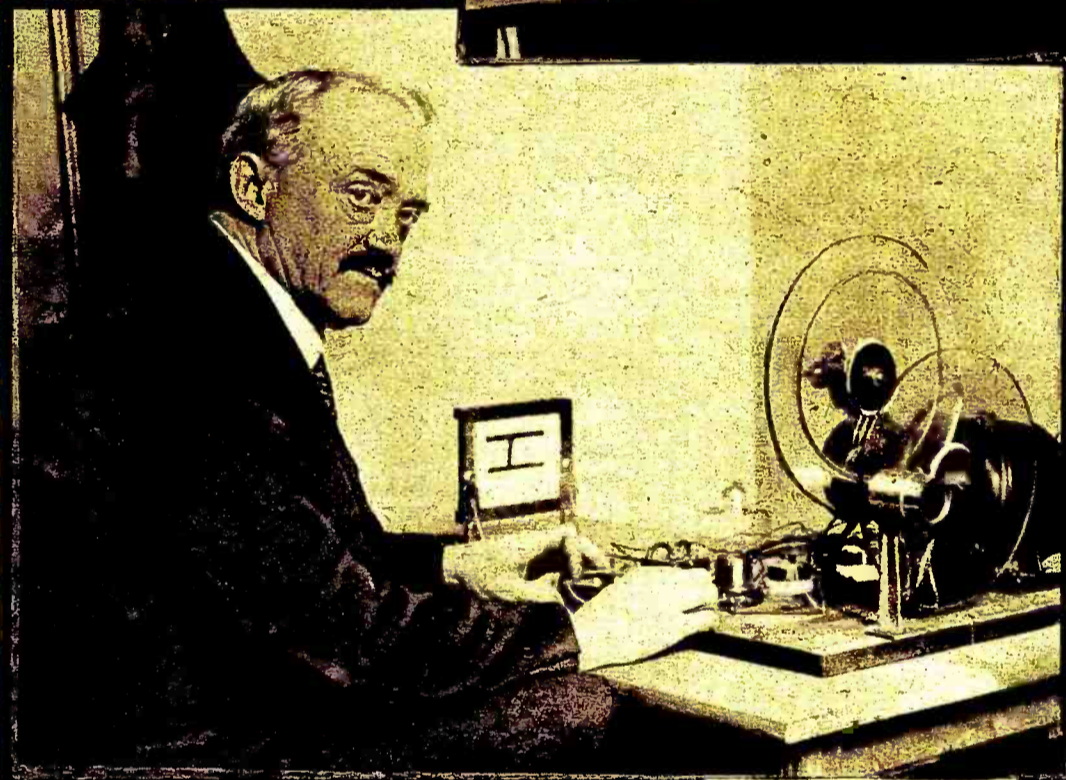
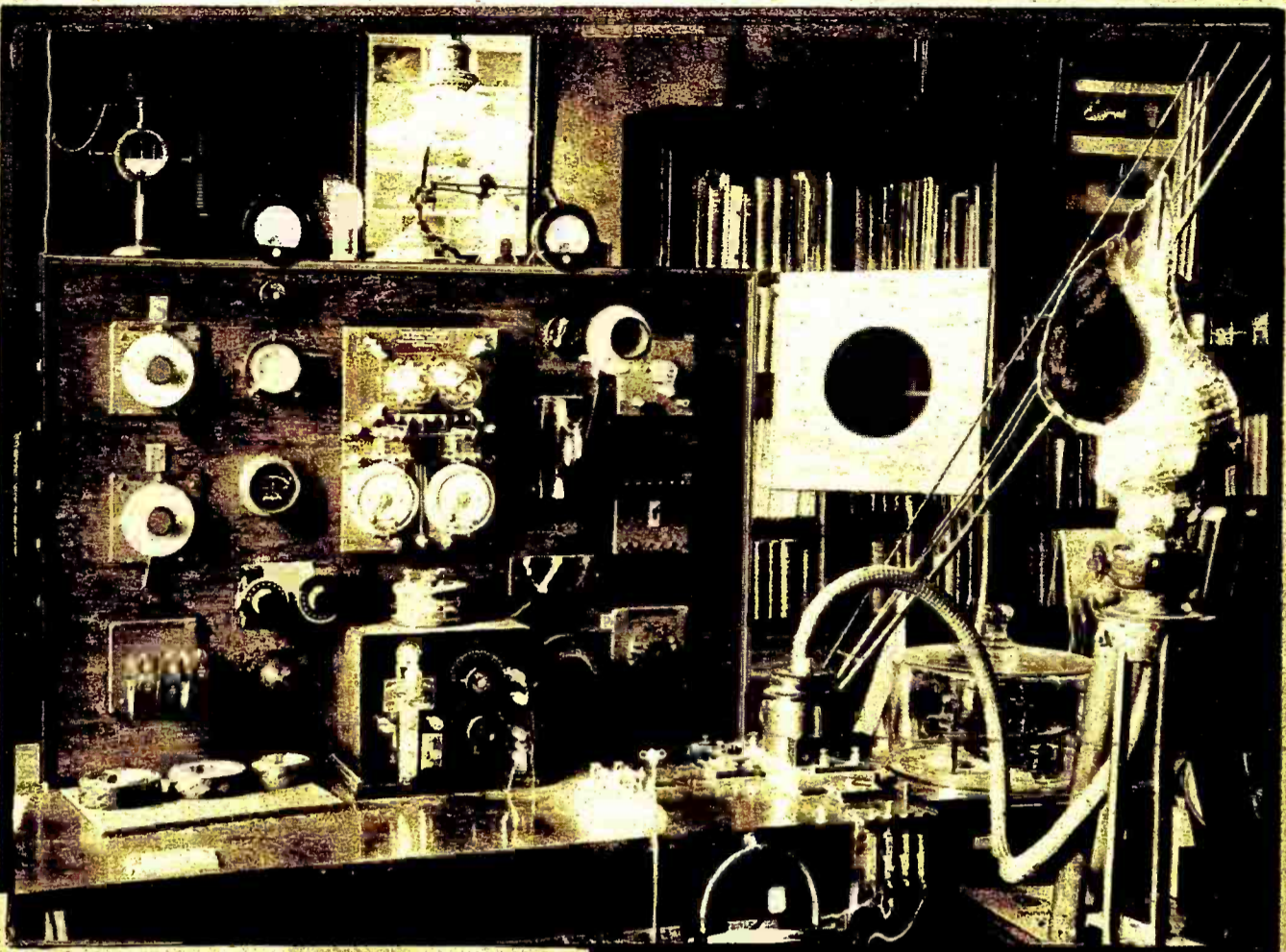

Broadcasting of motion pictures by radio has been made possible by the use of a new type of lens or prismatic ring, according to Mr. C. Francis Jenkins, the inventor of this system recently described by him. Photo shows Mr. Jenkins with the apparatus he invented.

(Photo by Fotograms)

Mr. Earl C. Hanson has invented a radio device to save fishermen lost in fog at sea. While away from the schooner the fisherman in the dory can hear signals from the mother ship with this instrument, which also indicates the direction from which the signals are emanating.

(Photo by Underwood & Underwood)

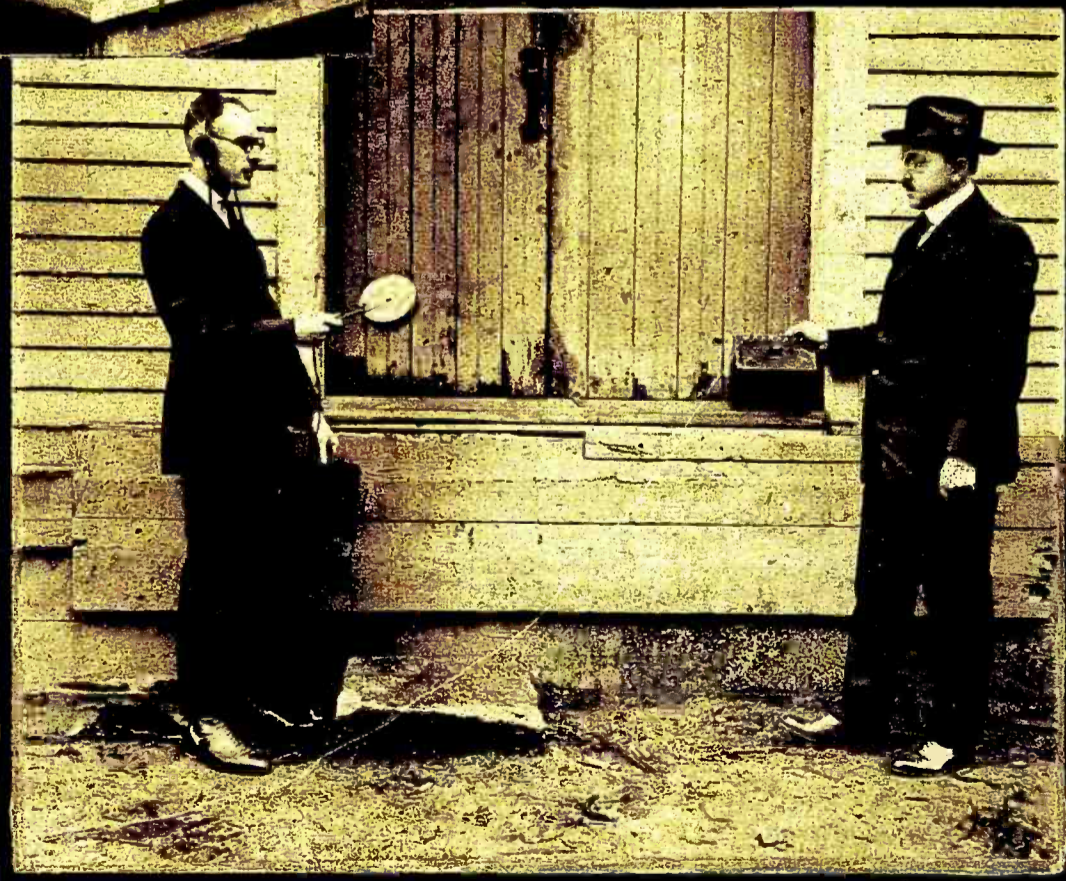

Radio Humor

Simp-lified Radio

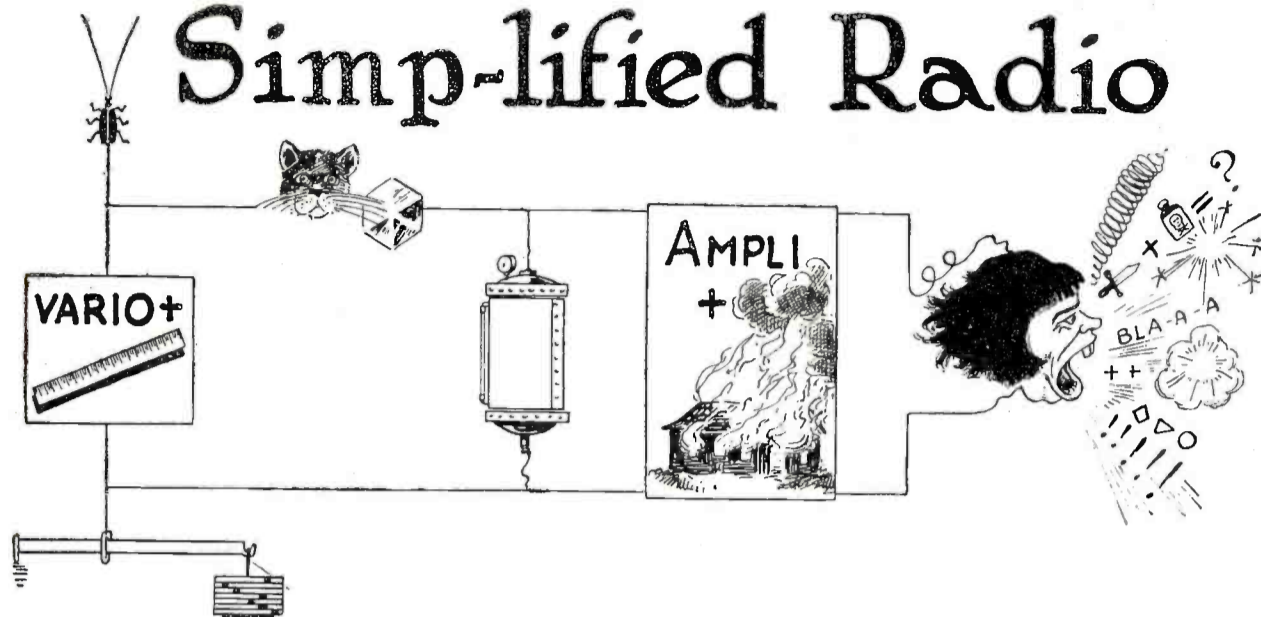

- | | | | | |
|------------------|-------------------|---------------------------|-------------------|--------------------|
| 1. Jack. | 8. Knob. | 15. Contact Point Switch. | 21. Loud Speaker. | 28. Buzzer. |
| 2. Panel. | 9. Dial. | 16. Plate. | 22. Amplifier. | 29. Ammeter. |
| 3. Hard Rubber. | 10. Socket. | 17. Honeycomb. | 23. Tickler. | 30. Two-Step. |
| 4. Plug. | 11. Key. | 18. Grid. | 24. Spark Coil. | 31. Loose Coupler. |
| 5. Binding Post. | 12. Howl. | 19. Antennae. | 25. Condenser. | 32. Transformer. |
| 6. Vacuum Tube. | 13. Copper. | 20. B Battery. | 26. Arc. | 33. Cat-Whisker. |
| 7. Crystal. | 14. Counterpoise. | | 27. Variometer. | |

Beginners Sometimes Find It Difficult to Interpret the Usual Radio Circuit Diagrams. If They Think This Method Looks Easier They Are Welcome to Use It. The Diagram at the Top Is the "Hook-Up" of a Crystal Receiver with an Amplifier and a Loud Talker. Try Drawing the Hook-Up of a Super-Heterodyne and Power Amplifier by the Same Method!



The Nightly Heir Schedule. "Tuning Up." —From Judge

The Only Apparent Advantage of This Type of Station Is That Absolutely No Apparatus Is Required. They DO Say, However, That the QRM Is Somethin' Awful.

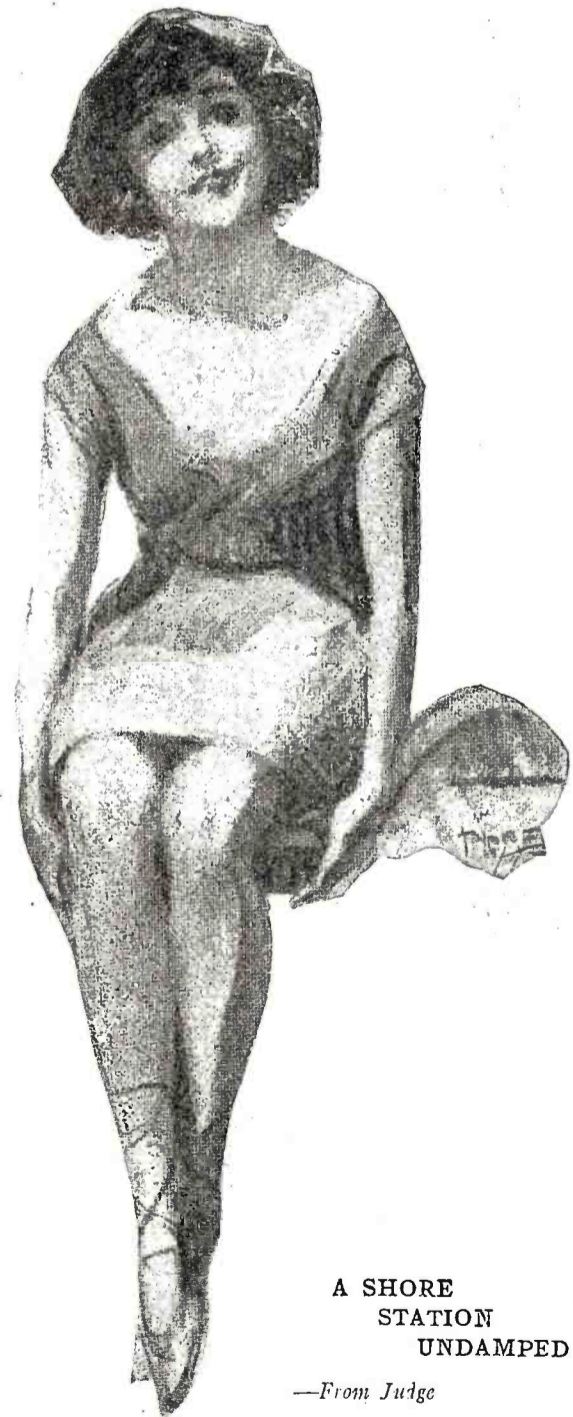

A SHORE STATION UNDATED

—From Judge

Shore Stations Have the Reputation Amongst Operators of Being Rather Lonesome, But If They Are All Like This One We Don't See Any Particular Reason Why They Should Be.

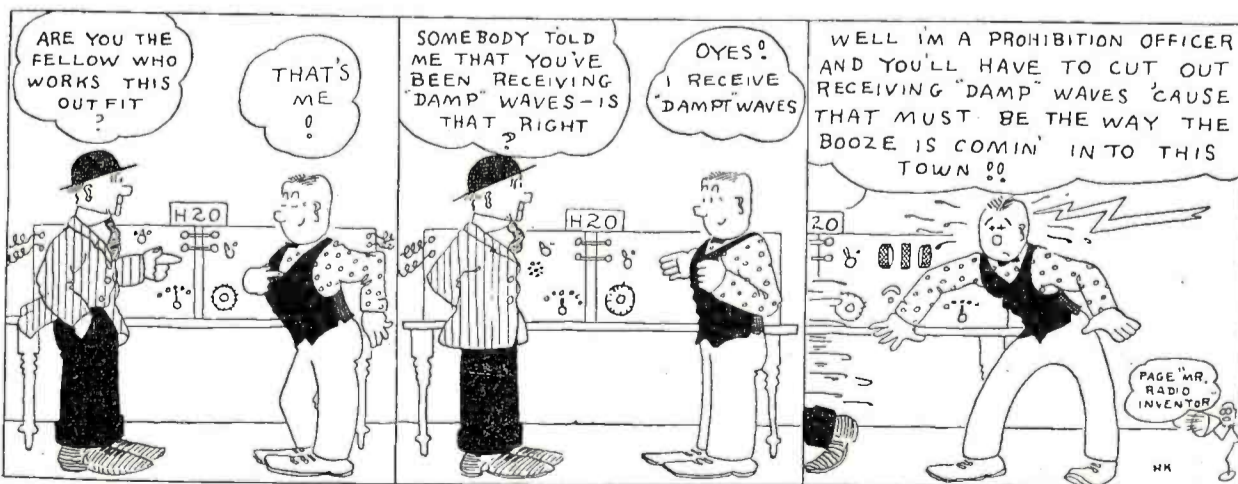

One More Argument for C. W.

Potash and Perlmutter Discuss This Here Radium Broadcasting

By MONTAGUE GLASS



"Wachsmann Tried to Tell Me It Was a Soprano Solo by the Name 'Land of the Sky Blue Water' with the Amplifier Not Working Right."

ME and Rosie was over to the Garfunkels last night, Mawruss, and listened in on one of them radium sets which Garfunkel bought it a couple days ago."

Abe Potash remarked to his partner, Morris Perlmutter, recently. "We could hear a feller in Newark delivering a lecture on *Some Common Diseases of Poultry* just as plain as if he would have been in the next room with a blanket over his head and his mouth full of mush."

"I heard the same lecture over to Wachsmann's electrical supply store on Lenox avenue, and Wachsmann tried to tell me it was a soprano solo by the name *Land of the Sky Blue Water* with the amplifier not working right," Morris Perlmutter said.

"Well, you didn't miss much either way," Abe said. "In fact, Mawruss, one of the best things you can say for this here radium broadcasting as a means of spending what some people call a pleasant evening is that outside of the initial cost of the machinery, y'understand, you are getting something for nothing, and you can always figure that something which you get for nothing ain't worth even that much."

"Still, Abe, you've got to admit that it's a wonderful thing how a feller like Garfunkel can sit in his own home on 110th street and hear a lecturer in Newark deliver a talk on *Some Common Diseases of Poultry* even though Garfunkel is in the pants business and the only one use he can get out of the information he receives from such a lecture is that he would swear off eating chicken fricassee in Wasserbauer's for the rest of his life," Morris remarked.

"Say! I've been steering clear of Wasserbauer's chicken fricassee long before this here radium broadcasting was ever discovered, which after a chicken has been dead for as long as them cold storage chickens that Wasserbauer uses in his chicken fricassee, Mawruss, it's immaterial to me *what* a radium broadcasting lecturer says such chickens died of," Abe declared.

BEDTIME STORIES AT 11:30

"Well, of course, lectures like *Some Common Diseases of Poultry* ain't the only turn on the program of them radium broadcasting performances, Abe," Morris said. "Every once in a while—say a couple of times a day—somebody sings *The Rosary*, and then of course there is the bedtime story, which in New York gets sent out somewheres around 7 o'clock."

"You would think that the people which is running such an up-to-date invention like this here radium broadcasting would know that the time to send out bedtime stories for New York children is not earlier than 11:30," Abe remarked, "which Garfunkel tells me that they tried to argue with their little boy Junior that he should ought to go to bed right after hearing the bedtime story from the Newark broadcasting station, and the kid gets so sore, y'understand, he goes to work and smashes fifteen dollars worth of apparatus on them."

A LECTURE ON OIL

"That seems to be the drawback in one of them radium outfits as compared to a phonograph, Mawruss," Abe said. "With a phonograph you can put on whatever record you want, and you could listen to one of these here Toschas, Jaschas or Saschas playing something elegant, a classical selection on the fiddle, y'understand, or you could get a hearty laugh out of Harry Lauder—provided the children ain't got the record scratched up too much, y'understand, but with this here radium broadcasting outfit, Mawruss, you ain't got no choice in the matter."

"You sit down all set to listen to a little good music, y'understand, and instead of anyhow Gallucurci, you get sprung on you from the broadcasting station at Albany J.K.X. *Tenth Annual Meeting of the Board of Directors of the Iron Dike and Land Reclamation Company,*

or maybe it will be a talk on *Why Lubricating Oils Lose Their Viscosity* by Hiram J. Lebkuchen, Editor and Publisher of *The Lubricating Oil World.*"

"There is other advantages which the phonograph has over the radium broadcasting apparatus, Abe," Morris said. "Any schlemiel could run a phonograph if he's got gumption enough to wind it up and put in a new needle occasionally, but while you ain't got to be a mechanical genius exactly to operate one of them radium outfits, y'understand, still a clumsy feller like you which could *Gott soll hutten* injure himself for life opening a safety pin, y'understand, would better leave one of them outfits alone if you don't want to be electrocuted exactly."

"Is that so!" Abe exclaimed. "I've got just so much mechanical ability as you've got, Mawruss, even if I didn't operate a sew-

(Continued on page 331)



"The Kid Gets So Sore, Y'understand, He Goes to Work and Smashes Fifteen Dollars Worth of Apparatus on Them."



"In this year, 1922, farming ain't nearly in such a bad way as Foreign Exchange."

"It's very easy to do that much damage to one of them outfits, Abe," Morris said. "I seen some of them in Wachsmann's electrical supply store which had starting and lighting systems on 'em like a Rolls-Royce already and you could hear programs being performed as far away as Boston."

"Then I presume if Garfunkel wanted to spend more money for his machinery, Mawruss, he could hear somebody sing *The Rosary* from even San Francisco even," Abe said.

"Further than that, too," Morris replied, "which in former days you could get crazy by some one singing *Silver Threads Among the Gold* from the next flat or maybe a couple of houses down the street at the furthest, but now there don't seem to be no limit to the distance from which you could be annoyed that way, especially if the electrical supply house talks you into buying one of the more expensive radium outfits."



"It Would Feel a Whole Lot Better if You Was in the Hospital for Something Legitimate Like Being Run Over by a Taxicab."

Self-Rectification

By D. S. BASIM

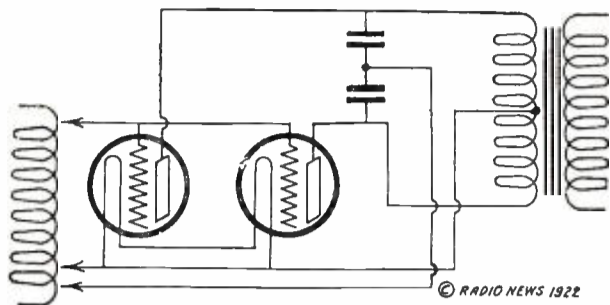

FIG. 1

Connections of a Self-Rectifier Oscillator.

MANY amateurs have wished to use 60-cycle A.C. on the plates of their transmitting tubes, but object to the low note produced. This objection is practically overcome by using self-rectification. All the power may be taken from the lamp socket with no noisy, moving or wearing parts, such as are found in a motor-generator set, or without using cumbersome and inefficient rectifiers of one type or another. A small step-up transformer, with the secondary tapped at the center, furnishes the plate potential, while another small step-down transformer furnishes the filament current.

The power put into a tube is generally limited by the heating of the plates, caused by excessive current. It is obvious, then, that with an A.C. plate supply there is no plate current flowing during one-half of the time, namely, that part of the cycle which puts a negative charge on the plate. Consequently, the plate does not heat up as readily as if a D.C. supply were used; therefore a much higher plate potential may be used without endangering the tube.

Now, if, while this negative charge is on the plate, and the tube is inoperative, we can get another tube to operate in the same circuit and at the same frequency, we will have a circuit which oscillates continuously, first one tube, and then the other furnishing the power. This is accomplished in the elementary circuit shown in Fig. 1.

Let us assume that the transformer has

charged the plate of tube I positive. This tube now oscillates through the circuit L-1 and C-1; tube II remaining idle, as the opposite terminal of the transformer is negative. When the cycle changes a positive charge is put on the plate of tube II, which oscillates through the circuit L-1 and C-2, tube I being idle. If the tubes used do not have the same characteristics, and all the leads are not exactly the same length, it would seem that the set would refuse to function properly; however, this is not the case, as tubes of widely varying characteristics have been used together with no ill effects. The condensers C-1 and C-2 not only prevent the high voltage from shorting through the inductance L-1, but also act as radio-frequency by-passes around the transformer, and cannot be eliminated.

Since the plate supply varies from zero to maximum 120 times per second, it would seem that the output of such a set would be a completely modulated wave. This, however, is not the case, as the tubes appear to overlap each other in actual operation, and the output is only slightly modulated. The

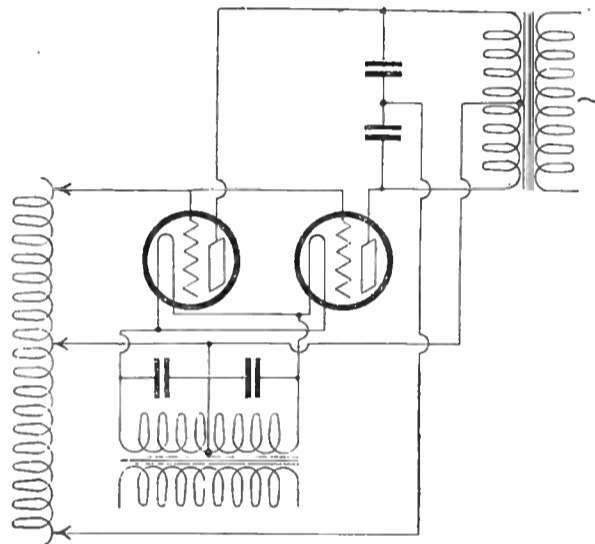

FIG. 3

In This Hook-up the Oscillator Tubes Act as Rectifiers, One Being Active While the Other is Idle.

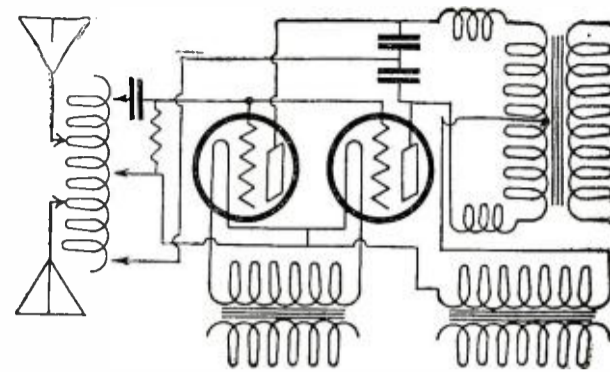

FIG. 2

Showing How the Filaments of the V. T. May Be Supplied with A. C. by Means of a Transformer Having no Center Tap in the Winding.

percentage of this modulation can be greatly reduced by inserting an audio-frequency choke of from 1 to 5 henrys between the center tap of the transformer and the filament connection. With such a choke, the modulation of the radiated current from the set may be reduced to five or ten per cent, which is very small and would hardly be noticeable at any distance. A set employing two 5-watt tubes and the circuit shown in Fig. 3 put two amperes into an average antenna and counterpoise; four tubes, two on a side, put 2.9 amperes in the same antenna system, and would have delivered more, but for the fact that the transformer was designed for two tubes, and consequently did not work four to their full capacity.

Fig. 3 gives the complete diagram for the set using two tubes. This set has been in use for several months, and has given perfect satisfaction. The inductance L-1 consists of 35 turns of edgewise-wound copper strip, although any well-insulated inductance would do. A good inductance may be made by threading a 5-inch micarta or fiber tube five or six threads to the inch, and winding with No. 12 bare wire. One of the best ways of bringing out taps is to bend and solder a short piece of brass strip around the wire while it is being wound on the tube. It is best to tap

(Continued on page 276)

Four Principles for Care of Radio Storage Batteries

By R. C. FAULWETTER*

IT is interesting to note that most descriptions of radio receiver hook-ups merely indicate the position of the batteries and the way the connections are made. Very little that is being written on this subject gives any authentic information whatever on the care of the batteries themselves. Information on this subject is most important if the operator expects to get the maximum service and efficiency from storage batteries used in the circuit. The function of these units is as important as any other part of the receiving equipment and they deserve as great, if not greater, care for satisfactory and economic operation of the set.

The most important single item is that of discharge. The state of charge of the battery should be watched even though it continues to heat the filaments of the vacuum tubes seemingly satisfactorily. A syringe hydrometer can be used to determine the state of charge very quickly and a gravity-reading of 1.100 or below should be considered as showing total discharge. Greater exhaustion of a battery may result in such hardening of the plates that it will be impossible to recharge it.

The second principle of battery care is that of insuring the proper level of solution

at all times. The electrolyte should cover the tops of the plates and insulators to the height of $\frac{3}{8}$ ". This is to insure the proper action over the entire plate surface and to prevent the uneven hardening of those portions which may be returned from the service station after recharging with the proper amount of water in it, but if it has been recharged by the operator himself, distilled water only may be added to bring the solution to the required level.

Third, extreme care should be exercised to guard against the introduction of small particles into the battery cells while the vent plugs are out during testing or filling. Especially is this true of such substances as metals which are conductors of electricity, or other materials that are soluble in the battery solution. These often cause internal short circuits or other internal action which render the battery inoperative and may result in sufficient damage to necessitate expensive repairs.

Fourth, terminal connections should be made secure by using either stiff spring clamps or the usual terminal connections that are common on automobile batteries. If such connections are not available heavy copper wires can be soldered to each of the posts to insure good contacts. Terminals and

connections ought to be coated with vaseline to prevent oxidizing action at those places, and thus prevent the forming of considerable amount of green crystalline lead and copper oxides around the posts of the battery.

Acid or other electrolyte solution should never be added to a lead plate storage battery except under very special circumstances. When the battery is fully charged, the positive and negative plates are composed of sponge lead and lead oxide respectively and the acid of the electrolyte is all in the solution. With discharging, the lead compounds change gradually to sulphate and the acid in the solution is absorbed in this process. Upon charging, the reverse action takes place and the acid is driven from the plates to the solution. The addition of any more acid or other electrolyte alters the exact proportions that are already properly adjusted.

When testing the solution with a syringe hydrometer, the electrolyte withdrawn for a reading must be returned to the cell from which it was taken. If this is not done, the result will be the same as adding more acid to one and removing some from the other, both of which are undesirable practices. Mistakes of this sort can be avoided by leaving the vent plugs in place except

(Continued on page 310)

*Willard Storage Battery Co.

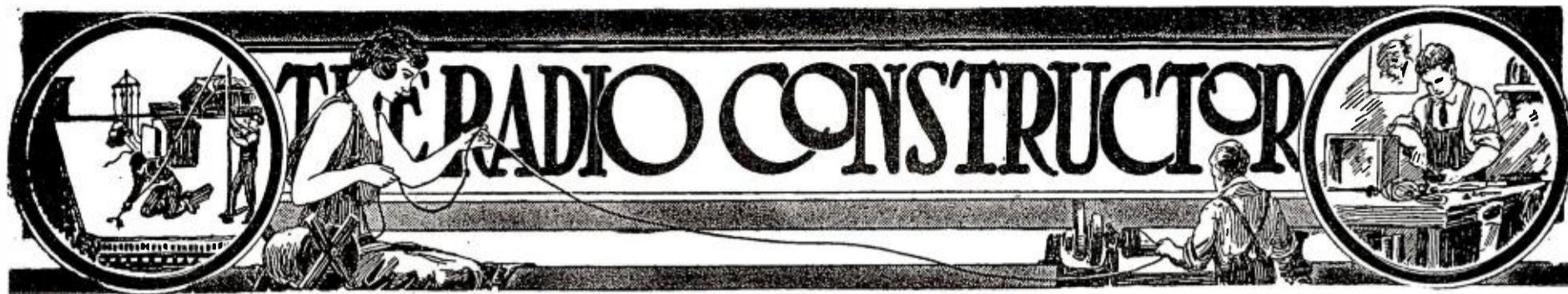

An Efficient Short-Wave Receiving Set

By PAUL G. WATSON

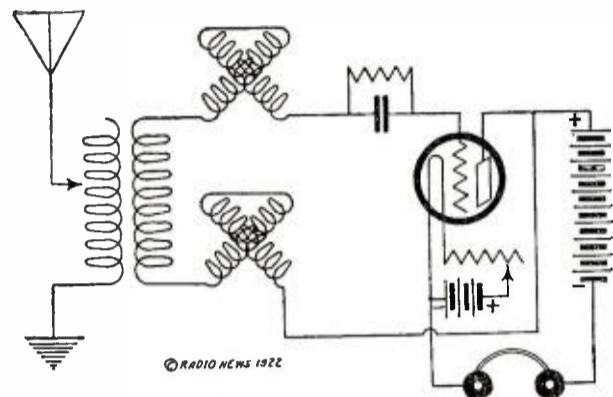

In this Hook-up the Phones and Plate Battery Form a Separate Circuit.

THE construction details of an efficient short-wave regenerative receiving set for music and other signals on waves up to 600 meters, are given in this article. The main construction details are made clear in the assembly drawing and the detail photo. The actual panel size need not be kept at the exact size given, but can be varied slightly to correspond with apparatus already on hand.

The variocoupler of the set shown in the photo is home-made. This coupler can easily be constructed at home, while the variometers involve much greater difficulty. The primary winding of the variocoupler consists of 40 turns of No. 18 D.C.C. wire on a 3 1/2" bakelite tube. This tube should be about 3" long, the winding starting near the top, say a half inch down, and is tapped every fourth turn. These taps go to the primary switch. By using taps on every fourth turn, the tuning will be sufficiently close without the use of a unit turn switch. The shaft for the ball secondary is placed diametrically through the top of the tube sufficiently above the primary winding to prevent the winding from touching on the shaft. The shaft is a 3/16" round brass rod, and need not be divided in the ball as connection is made through flexible leads. The secondary form is the usual "Ball" rotor and is 3" in diameter. It has 34 turns, 17 on each side of the shaft, of No. 18 D.C.C. wire. The flexible leads, previously mentioned, are about 1' long, of tinsel cord, and are soldered to the ends of the secondary winding and then fastened under a brass screw to prevent pulling out of the windings. A base can be fitted on the lower end of the primary tube, and this base then mounted on the subbase of the set. The coupler in the picture is mounted by having a flexible fiber strip passed around it, both ends of which are fastened tightly to the back of the panel with brass machine screws.

If a coupler is to be purchased instead of made, the "Simplex" coupler will work very well in this set,

and has several advantages over some of the other types.

The variometers of the original set were not home-made. The time and skill required in making them, as well as the necessity for a lathe, making it impractical for a great many to construct the two variometers. There are a number of good ones on the market at the present time, and in connection with a "Simplex" or a home-made coupler, "Simplex" variometers would work best. However, for those who desire the home-made variometers, the essential dimensions of the variometers used are given: The stationary blocks are 1 1/8" thick, and 6" square. The space for placing the stationary winding is spherical, 4" in diameter. Two such blocks are required for each variometer. A form for placing the stationary winding should be made with a curve radius about 1/16" less than that of the stationary block of the variometer. The winding is placed on this form, the stationary block is given a coat of thick shellac, and the winding pushed in place, and held, on the winding form, which is later removed.

The two halves of the stationary element are separated 1/2" by the two brass strips serving as bearings for the rotary element. Fifty turns, 25 in each half, of No. 18 S.C.C. wire compose the stationary element.

The rotor of the variometers is similar to that of the variocoupler, except that it is larger mechanically and electrically. The variometer rotor is 3 3/4" in diameter, and has 50 turns of No. 18 S.C.C. wire wound on it, 25 turns on each side of the shaft.

The variometer shaft is 3/16" in diameter, and is divided in the middle of the ball so that contact to the rotor can be made to it through stiff brass brushes. The need for

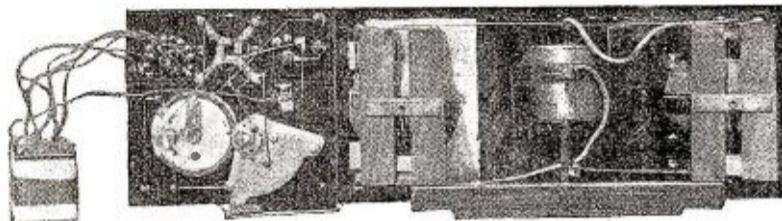

Back View of the Set Showing How the Parts are Mounted on the Panel.

accurate work on the variometers should be self-evident. If the ball is not centered accurately, the two elements will rub, tearing loose the stationary winding, and causing a great deal of noise in the set.

Shielding for removing the "Capacity Effect" while tuning is placed on the back of the panel, where the grid variometer is mounted. It is a piece of tinfoil about 7" square insulated from the variometer, and fastened to the panel with shellac. It is connected to the ground terminal of the set. Extreme care should be used, to see that the variometer is not grounded.

Three-inch dials should be used on the two variometers and the variocoupler; a number of styles may be used to suit the readers.

The variable grid condenser used in the set shown is a .0005 Mfd. "De Forest" condenser, but if necessary to keep the cost down, a fixed condenser, also containing the grid leak can be substituted with fair results for the first one. The grid leak used with the variable condenser was a "De Forest" pencil-mark leak which can be varied by the use of an eraser to suit any tube which might be used.

The audion socket should be one that will give a firm contact to the prongs of the tube, the "General Radio" No. 156 being used in the original. The audion rheostat should be carefully selected, to pick one which will give a close variation of current. Many of the noises of an audion circuit can be traced directly to the poor contacts in the rheostat. Care should be used to pick one having sufficient capacity for the newer types of tubes now in use.

A variable "B" battery is used in this set. Better results were obtained by using a variable battery made from three-cell flash light batteries, than that obtained from a fixed plate voltage. Ten three-cell batteries were used with excellent results.

The "B" battery switches should have alternate live and dead contacts to avoid short circuiting as the switch lever passes from one to the other. The circuit for wiring is given in the accompanying diagram. It is an "Ultraudion" circuit, the two variometers being placed in series with the two leads of the secondary of the vario-

(Continued on page 274)

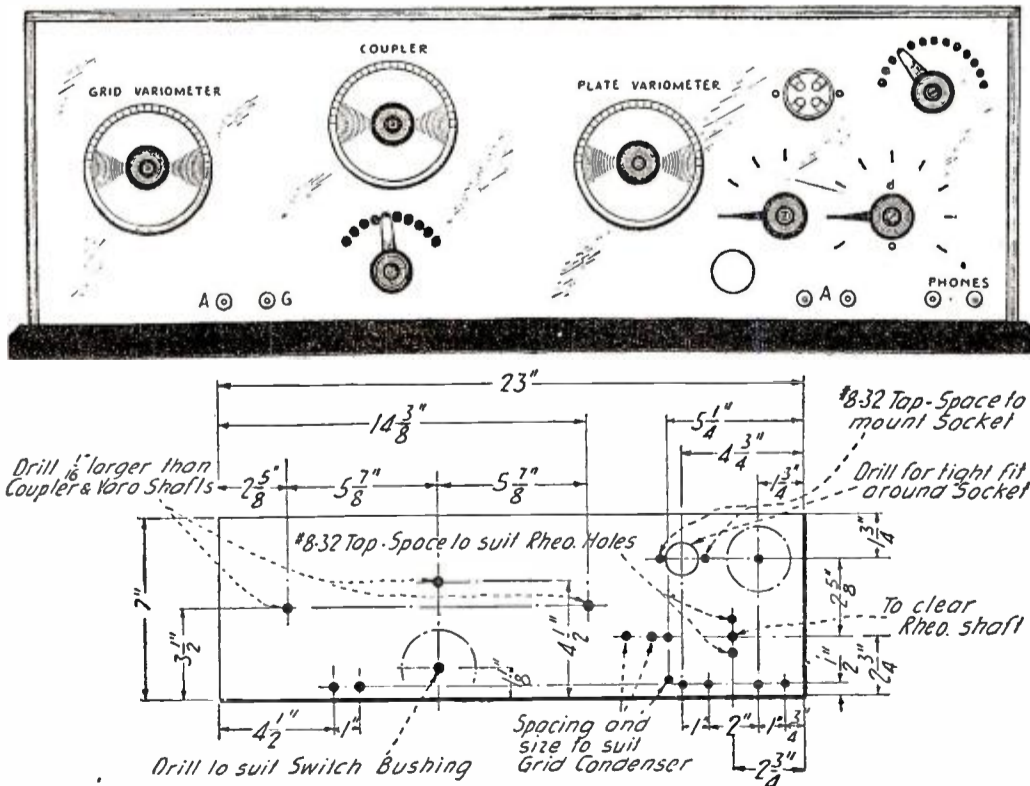

Above is the Layout of the Front Panel of the Set in Which the Controls for the Vacuum Tube are Incorporated; Below are Given Dimensions for the Drilling of the Panel.

A Simple and Practical Variable Condenser

By J. A. FRANK

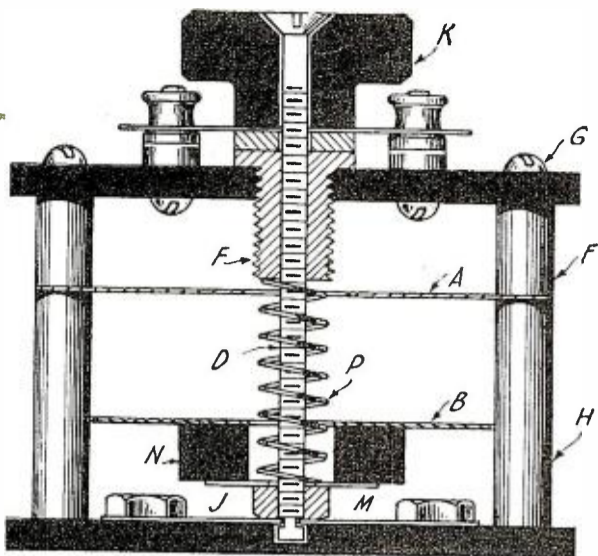

Such a Condenser May Be Used as a Vernier or May Be Made to Have a Greater Capacity By Using Mica Dielectric.

The variable condenser has always been the bugbear of the amateur who constructs his own apparatus, inasmuch as he is usually not equipped with the tools necessary for the building of an efficient rotary condenser. The following is a description of a variable condenser, which possesses all the good qualities of the rotary condenser and yet so simple in construction that it can be built by the average amateur with ordinary skill at handling tools.

For a given capacity this type condenser takes up less space than a rotary condenser and is its equal in both efficiency and mechanical strength. As it takes up a panel space of only 2½" square, it is ideal for portable sets and all cases where compactness is of prime importance. Furthermore it can be built at a minimum of expense, consistent with efficient operation. No machine work other than the drilling of the holes in the various parts is necessary, and all its parts are of standardized stock, readily obtainable on the market.

The principle governing its operation is very simple. By looking at Fig. 2, it will be seen that variation of capacity is obtained by increasing or decreasing the amount of air space separating the two plates "A" and "B." A very high capacity is obtained by the use of an extremely thin mica washer "C," which takes the place of the air dielectric for the higher capacities. As the movable plate "B" travels along the screw "D," the capacity is varied from maximum to practically zero.

The construction will be easily understood from the drawings. The base and top panel are each 2½" square. They were made by cutting a 5"x2½"x1/8" bakelite panel exactly in half. Clamp the two pieces together and drill the four holes at the corners for the standards. While still clamped together,

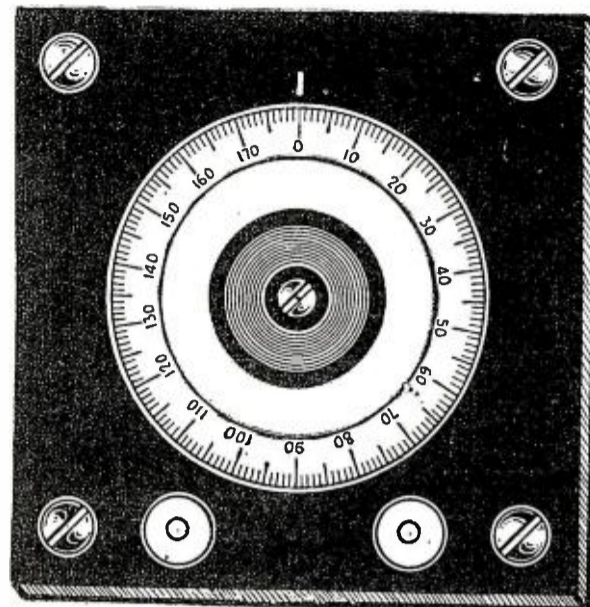

Top View of the Variable Condenser. Note the Dial With the 360° Scale.

drill a 3/16" hole through top and half way through the base for the center revolving screw "D." Unclamp the pieces and re-drill the center hole in the top panel to accommodate the threaded portion of the bushing "F" Figs. 2 and 3. This will insure the holes in the two pieces exactly corresponding when the instrument is assembled. (Continued on page 288)

Radio Cabinets

By L. M. KLINEFELTER

ONE of the greatest difficulties confronting the amateur in the building of his own radio set is, in a great many cases, the cabinet. Many a set, otherwise a model of neatness and efficiency, is housed in a case that is anything but professional in appearance.

With the thought of offering some suggestions to overcome this condition, two styles of cabinets are shown, both of which are comparatively simple to make and if properly made present a good appearance.

Almost any well-seasoned wood, if given a good finish, is suitable for cabinet construction, but mahogany, quartered oak and walnut make especially nice boxes and the slight difference in price between these woods and the cheaper varieties is more than overcome by the satisfaction derived from owning a "real mahogany" or walnut cabinet. Aside from this, the better woods are naturally more beautiful in appearance and take a good finish to a better advantage.

Quartered oak can generally be secured from local lumber dealers, but walnut and mahogany are sometimes hard to obtain. Most towns boast of one or more cabinet shops, store fixture builders or furniture re-

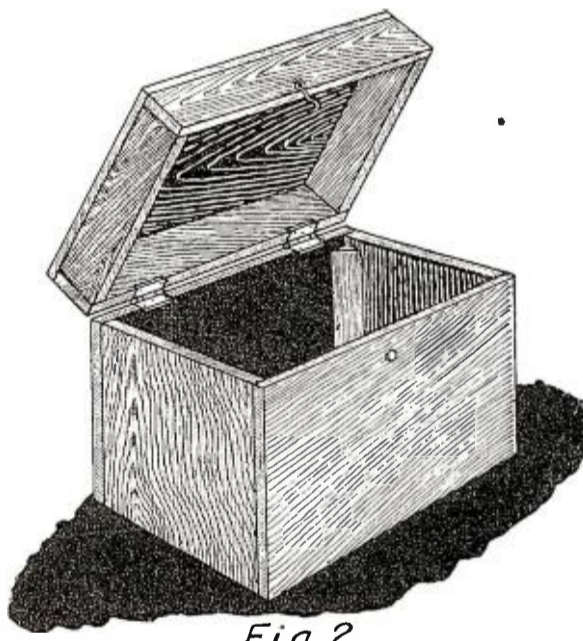

Fig. 2

For Portable Sets Such a Box Is Most Convenient.

pairers who carry a small supply of these woods and are willing to sell in small quantities. As 1/4" to 3/8" is the usual thickness for radio cabinets, you can have inch lumber resawed, or split, thus getting two square feet for every board foot you buy. This should then be dressed on both sides to as near as you can get to 3/8". Unless you have access to a school manual training shop having power saws and planer to do this work, or some similar shop where you can have it done, it is better to buy your material already dressed to proper thickness.

Coming now to the construction of the cabinets. The one shown in Fig. 1 and Fig. 2 has a hinged top and is for portable sets and instruments, such as wavemeters, while the one in Fig. 3 is of the usual front panel variety. Both are made without the use of the mitre joint, which is likely to prove troublesome to the amateur.

To make the portable box, first get out the bottom and ends. The bottom should be

about 1/32" larger each way than the panel you are going to use in the box. The length of the ends will be the same as the width of the bottom. The width of the ends, which determines the inside height of the box, will depend upon the size of the instruments below the panel. Allow 1¼" for dials and 1/4" for sawcut and for smoothing up and matching edges after the box is cut open.

Apply glue to the ends of the bottom, let it soak in and apply more. Then nail on the ends with 3/4" or 1" brads. Now apply glue to the ends of ends in the same way and to the edges of the bottom, and nail on the front and back, which will be the same width as the ends, and whose length will be the length of the panel plus the thickness of the two ends. Be careful not to get a brad on the line where you are going to saw off the top. Glue and nail on the top and the box is made.

Now set all nailheads below the surface with a small nailset and blockplane ends of sides and top even with the surface of the box ends. With a piece of coarse sandpaper on a block, sand all over thoroughly to remove planer and other marks. While it is usually considered better practice to scrape or plane out these marks with a hand (Continued on page 282)

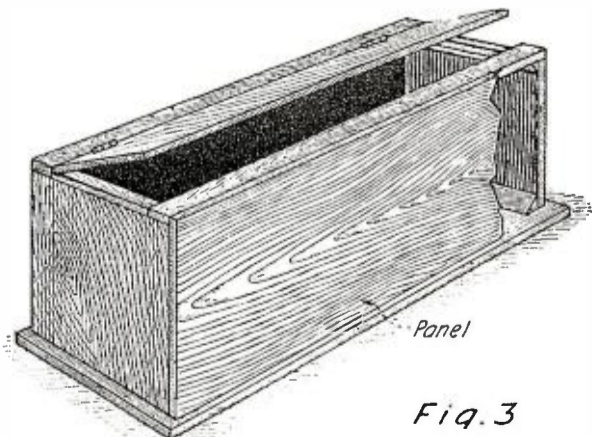

Fig. 3

The Typical Cabinet for Regenerative Receiver and Amplifier.

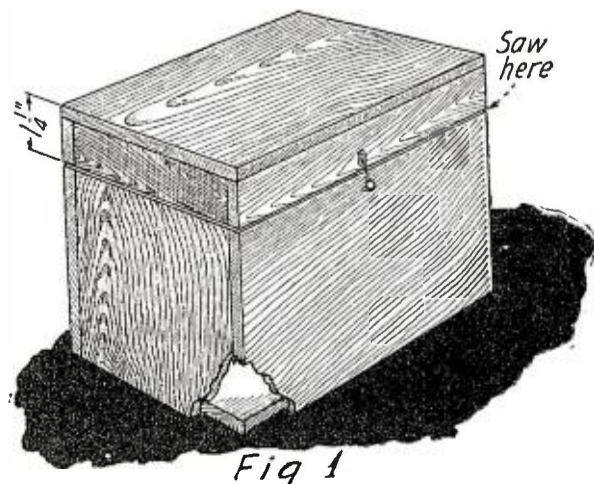
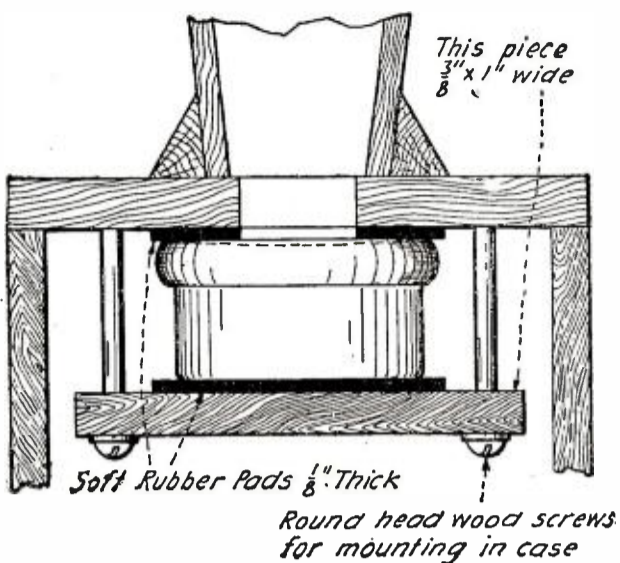

Fig. 1

Showing the Details of Construction.

How to Build a Loud Speaker

By PAUL G. WATSON



Mounting of the Telephone Receiver in the Base

A GREAT many designs of loud-speaking receivers are on the market today, all with metal horns of some form or other. With practically no exceptions, these devices reproduce music and voice with a harsh, metallic sound similar to old models of the phonograph. The present models of loud speakers are somewhat smaller in size than the wooden horn described in this article. They are designed to be placed on a table or stand, while this wooden horn is of sufficient size to stand on the floor, in the parlor or such places where a finished piece of apparatus is necessary. This horn, as described here, will stand from 36" to 40" high, and requires a floor space about 10" square.

The reproducer unit is a Baldwin type "C" mica diaphragm telephone. It is mounted in the box at the base of the horn, the method of which is shown in the cross sectional drawing of the base. The receiver unit is clamped against the top of the base by a wooden strip, held in place by two long wood screws passing through the strip into the top of the box. Pads of rubber are placed wherever the receiver case touches the base. Pieces of an automobile inner tube will serve this purpose. The phone should be mounted firmly, but not tight enough to crack the case.

The dimensions of the base are of minor importance, as long as the base is large enough to keep the horn upright, a size from 9" to 10" square being about right for the horn described here. The height of this box, or base, should be about six or seven inches.

The hardest feature in construction is the bending of the front and back panels at the horn. The proper way to do this is to boil the parts to be bent in water for several hours and then bend them over a form, on which they are allowed to dry. Much of the tendency to spring out of shape is eliminated by this method of bending. The cleats shown in the assembly drawing prevent the thin material from bending or warping after it has been put in place. They should be fastened with small brass

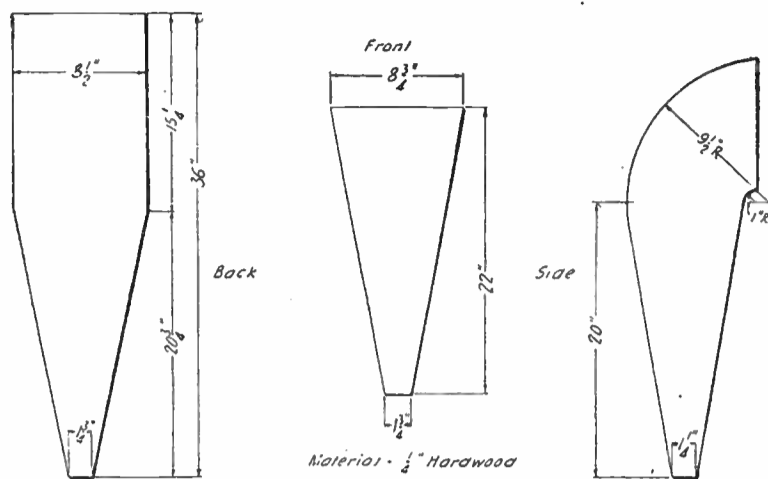

Shape and Dimensions of the Pieces Needed for the Construction of the Horn

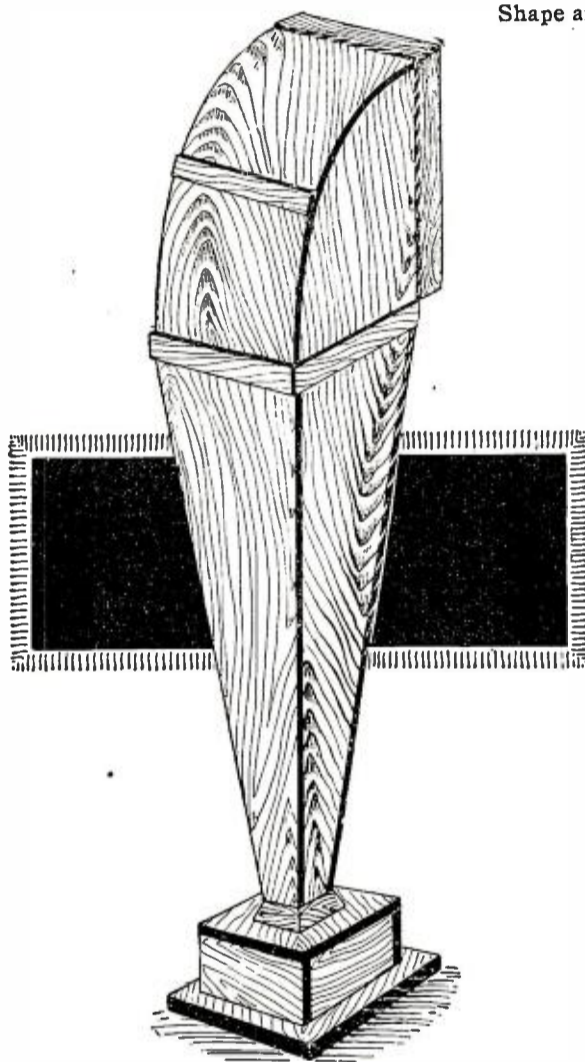

Such a Wooden Horn Amplifies the Sound Produced By a Telephone Receiver, Thus Making a Loud Talker Without a Tiny Sound

wood screws and glue. Only cleats necessary for strengthening the horn are shown in the drawing. A much neater appearing horn can be had by working these cleats into a system of paneling. To bring out the points where strength was needed, the remainder were omitted. The cleat passing under the front panel, having the short bend, should have its upper side rounded to fit this bend, and should be glued and screwed in place. In any case, where cleats are added, it must be on the outside, to give a clear passage for the sound.

The four pieces of the horn are fastened together after bending and drying, with small nails and glue. The joints in the straight section of the horn can be strengthened by the addition of triangular blocks, glued in the corners. A small brass bracket may be placed under the cleats at the large end of the horn to hold the joint together if necessary. The lower end of the horn should be squared off, and is fastened to the base by four triangular wooden blocks mitered around the lower end of the horn. These blocks should be screwed and glued to the horn, and then fastened to the baseboard in a like manner, making a very rigid joint.

The remainder of the base is put together with round head screws and has no complicated details, being only a simple wooden box, made of 1/2" stock, while the bottom or baseboard is made of 3/4" stock. A small hole is drilled in one side for the phone cord to pass, or, if desired, a pair of binding posts can be placed on the top of the base.

(Continued on page 278)

The Construction of an Ideal Short-Wave Receiver

By EDMUND S. SMITH

THERE are a great many amateurs who would like to own a Paragon R. A. Ten, but are unable to on

account of the high cost of these excellent sets. For this reason, they usually buy or make regenerative sets which, however, are not nearly as efficient. It is the purpose of this article to describe the construction of a very efficient short-wave regenerative set using the Paragon R. A. Ten Single variometer circuit, with a few improvements.

The main difference between the set shown in the photograph and a Paragon is in the use of two Groves coils in place of the variocouplers. By direct comparison in three different stations, these have been found to be superior to a variocoupler. The reason is obvious, in that these coils are not tapped, thereby doing away with dead-end effects

and switch losses. The large diameter of these coils is also partly responsible for their success. The particular design of this type of coil is due to Mr. A. L. Groves. He, however, used them in the standard tickler-feedback

(Continued on page 278)

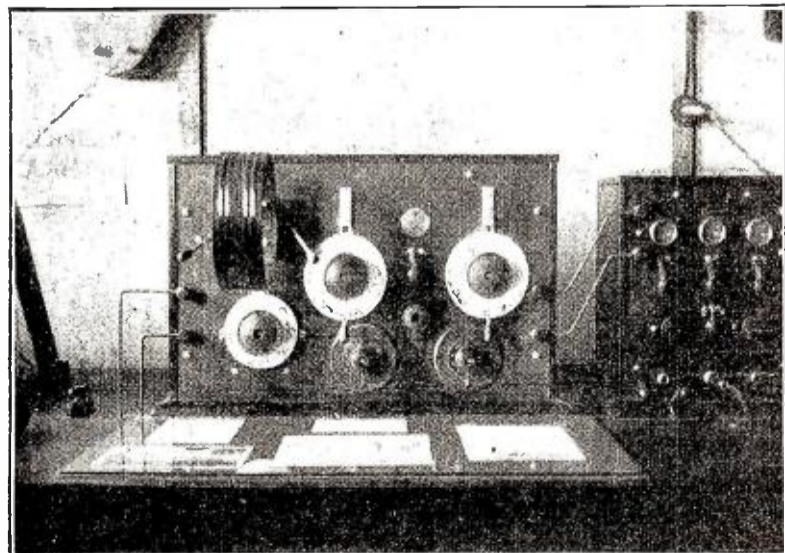

Mr. Smith's Set; Note the Special Coils and Arrangement of Parts

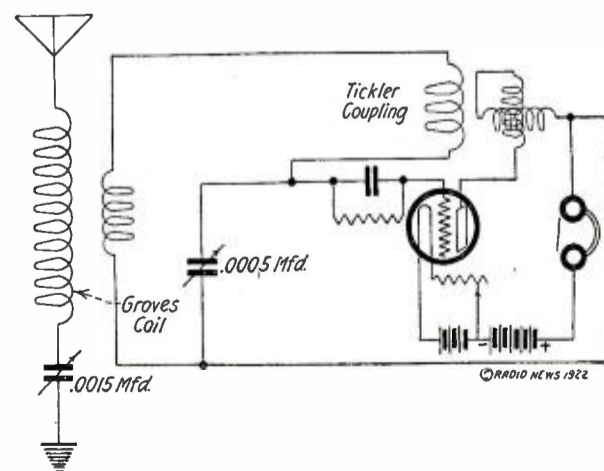

The Hook-Up is Similar to That of the Paragon Receiver

Winding and Using Honeycomb Coils

By HARRY L. GRAY

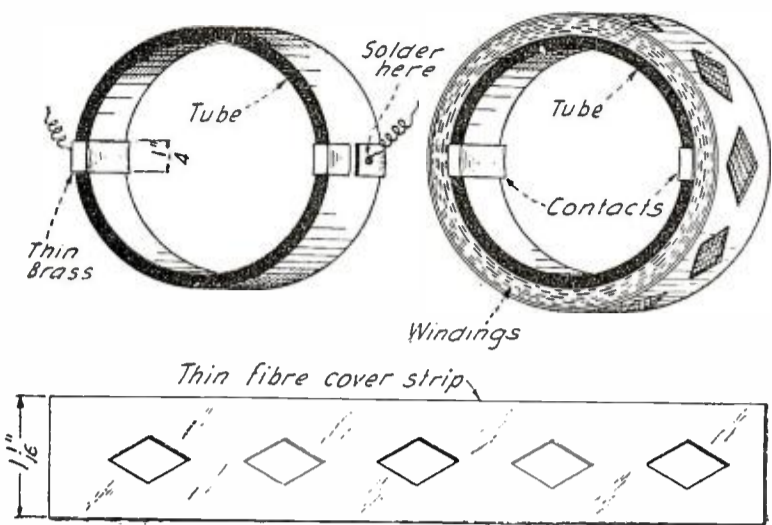

When the Coils are Wound, Some Fibre Strip is Placed Around to Give Rigidity and to Protect the Winding

THE Honeycomb, or lateral wound coils, have been found to be very efficient on all wave-lengths, and the station which is equipped with these coils will be able to receive from all stations, no matter what the wave-length may be. The very shortest or the very longest waves may be received on the same set.

The tuning is all done by variable condensers or variometers, according to the circuit used.

The amateur can easily wind these coils for himself by following the directions here given. Also the manner of mounting here described, I think, is much simpler and neater than that which is generally used.

To begin with, procure some good cardboard tubing which is two inches, inside diameter. As the coils are to be one inch wide, the tubing should be cut in sections of that width.

Have a block turned to fit this tubing nicely. If it is not possible to have it turned, it may be whittled. Place one of your tubes on this and mark two lines at the edge of the tubing. These lines are then marked off evenly with a compass into 25 spaces, then small brads should be lightly driven on these lines on the spaces.

Before the tube is placed on the block, however, the contact strips should be placed on the tube. These are merely strips of thin brass or copper about 1/4" wide. It should be clinched on tightly, as shown in the drawing. When you are ready to wind, solder the end of your wire to one of these contacts, so that it will be covered with the winding, also solder another short piece to the other contact, and when through winding, solder the end of the wire to this short piece. The soldered joints will then be concealed.

Wind according to the pattern, as shown in the drawing. Start at a peg nearest the contact and wind to the 13th peg on the opposite side, which is just half way around, and then back to the next peg ahead of the one you started from. When you have continued in this manner until all the pegs have a wire on them you will have 25 turns, or one layer, on the coil.

Use No. 24 cotton or silk-covered wire for wave-lengths up to 1,000 meters, and on the larger coils a finer wire may be used to save space; in this case as fine as No. 30 may be used. I have never seen enameled wire used on these coils.

The following number of turns have been found satisfactory on wave-lengths as given: 25 turns, up to 400 meters; 35 turns, 400 to 600 meters; 50 turns, 600 to 800 meters; 75 turns, 800 to 1,000 meters; 100 turns, 900 to 1,200 meters; 300 turns, 1,500 to 2,500 meters. Other wave-lengths may be estimated from these figures.

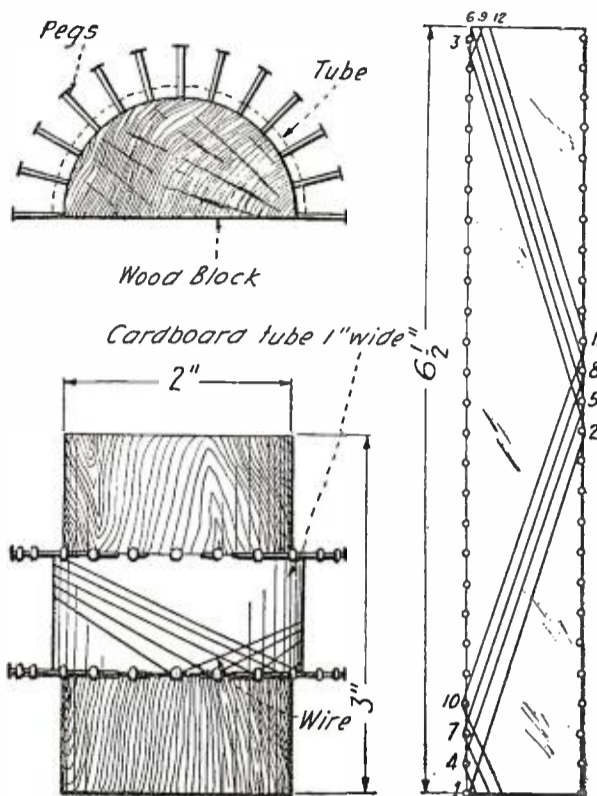

The Coils may be Wound by Hand Around a Piece of Wood into Which are Driven Nails.

The wave-length will depend considerably upon the size of aerial used, also the capacity of the condensers. The variable condenser on the primary should be of .0015 M. F. and should be arranged with a switch so it may be connected either in series or parallel. The secondary variable condenser should be of .001 M. F.

After the coils are wound, a cover strip will improve the appearance. This is made from thin fiberboard, but cardboard may be used. A row of diamond-shaped holes should be cut along the center of the strip. The strip is then glued on and wrapped with twine until the glue has set. The winding will project slightly over the edge of the tubing, so the cover strip should be made slightly wider than the tube. After the cover is glued on and set, remove the twine and smooth the joint in the cover with sandpaper. The coil should then be dipped in white shellac of the best grade, or better still, celluloid varnish, which can be made from the following formula:

- Amyl Acetate..... 1 pint.
- Fusel Oil (refined)..... 1/2 pint.
- Benzine..... 3/4 pint.
- Wood Alcohol..... 3/4 pint.
- Castor Oil (by weight)..... 1 ounce.
- Soluble Cotton..... 2 ounces.

(Continued on page 274)

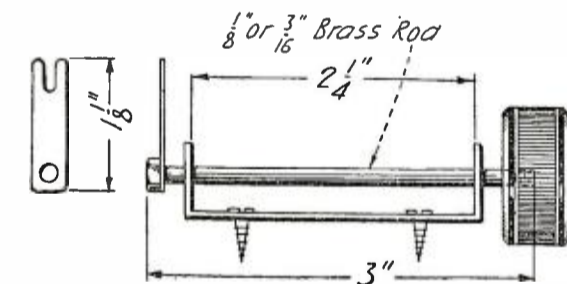
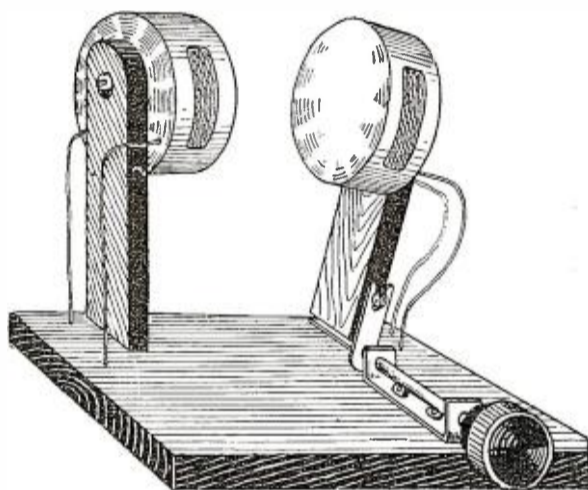

A Simple Type of Coupler for Home-Made Honeycomb Coils.

A Low Voltage Filter for Radiophones

By EUGENE W. APPLEBAUM

A VERY efficient filter for the plate voltage of a radiophone set can be constructed with a few telephone induction or repeating coils and telephone condensers.

Induction coils with a very small ratio, from 1-1 to 3-1, will work best. The insulation between the primary and secondary windings is sufficient for the voltages usually used on the five watt tubes. About six or eight of these coils will filter out the usual generator hum very nicely, but more of these coils should be used on rectified direct current.

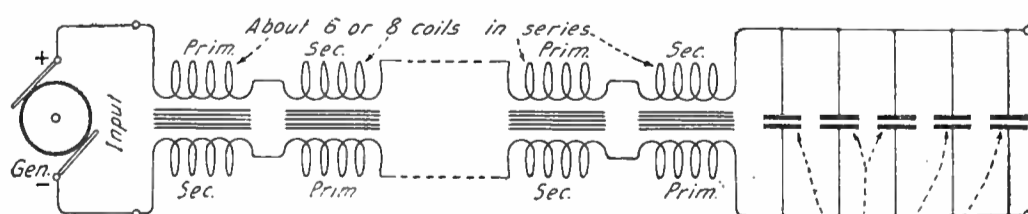

Fig. 1

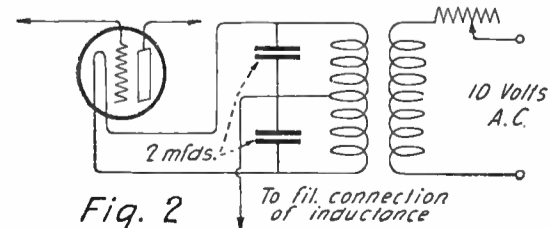

Fig. 2

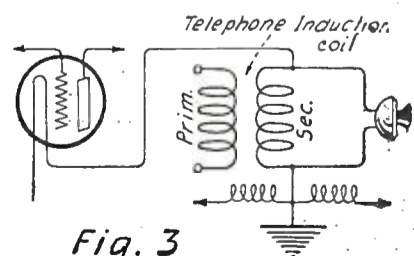

Fig. 3

A Very Efficient Filter Circuit may be Constructed with the Secondary Windings of Spark Coils and Standard Telephone Condensers.

Connect them as in Fig. 1, so that in the complete filter the reactance or impedance on the positive side of the generator will approximately equal that of the negative side.

The filter condensers may be made up of ordinary paper dielectric telephone condensers of one or two microfarads capacity. These condensers may be purchased rather cheaply; making it possible to build a condenser of from 10 to 20 microfarads capacity.

These condensers are just
(Continued on page 276)

Watch Case Receiving Set

By BRAINARD FOOTE

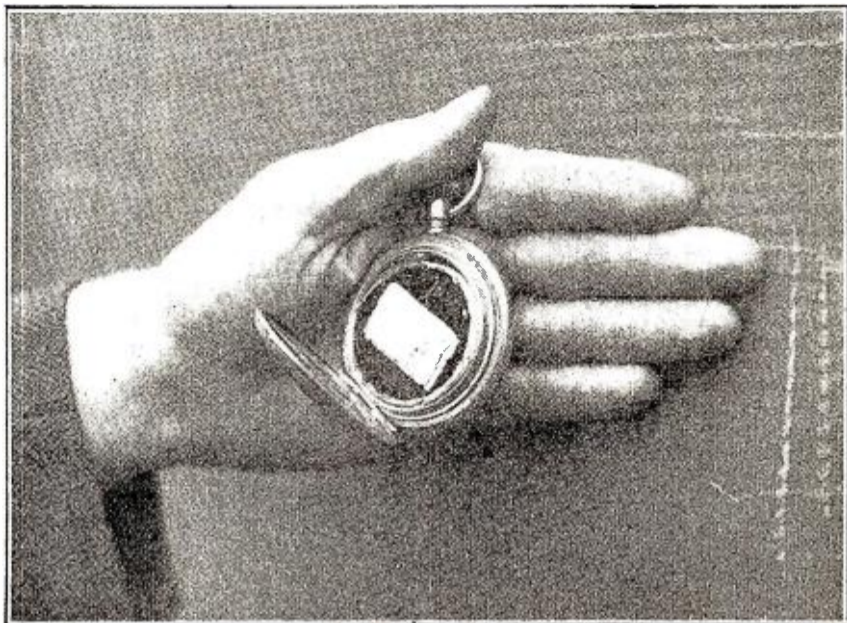

This Receiving Set Enclosed in A Watch Case is Complete in Every Detail. The Inductance is Tapped and the Crystal Detector is Adjusted by the Winding Stem. Good Signals Have Been Obtained with this Miniature Receiver.

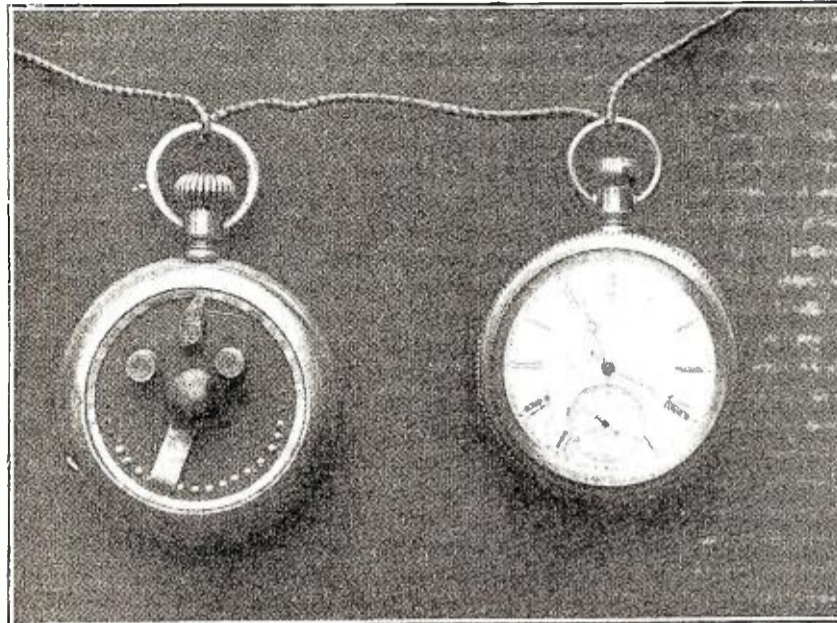

MANY newspaper stories have been built around photographs of pocket radio sets showing umbrellas, or a wire coat lining as the antenna, despite the fact that such apparatus would not operate over a distance greater than a few blocks from a powerful transmitter. Moreover, seldom do they contain more than a crystal detector, although it is well known that it is necessary to use a coil whose inductance is variable for real results. The receiver described herein is complete in all the details of a single coil set.

The antenna used may be a single wire approximately 100 feet long, while the ground is furnished by a convenient water pipe. The receiving range of the set for the average broadcasting station is about 25 miles. WJZ and 2XB have been received at a distance of 10 miles with an indoor antenna of one wire 50' long.

Although the construction of the watch-case receiver is simple, a little patience will be required in the handling of the fine wire used. The circular panel supplants the watch crystal and dial, and is $1/16$ " in thickness. The watch case used is $2\frac{1}{4}$ " in diameter and $5/8$ " in thickness, and this makes the panel $1\frac{3}{4}$ " in diameter. A semi-circle $5/8$ " in radius is described from the center of the panel, and 16 holes are drilled with a No. 60 drill, spaced $1/8$ " apart. Common pins are used for the switch points, clipped off $1/8$ " below the head. The illustration shows the location of two small binding posts, and the position of the crystal holder and of the hole through which the cat-whisker protrudes.

For the coil, a cardboard tube is used, being in this case $1\frac{9}{16}$ " in diameter and $7/16$ " in length. The tube is shellacked, and the winding begun before it is quite dry. No. 34 or smaller wire is employed for the coil, and the wire from an old telephone receiver of the 75-ohm variety will do very well for this purpose. A pinhole is punched close to the edge of the tube and the end of the wire fastened through it, leaving about 2" of the wire for connections. Wind on two turns, keeping the wire straight and the turns close and parallel to each other. Place another pinhole close to the second turn and $1/8$ " further along in the direction in which the wire is wound. A 1" loop is made in the wire and the loop pushed through the hole for the first tap. Handle the coil carefully, and the shellac will prevent the loop from coming out. Continue in this manner, and take a loop out at the end of every two turns until 15 loops have been brought out. There is now another layer of wire to be wound on, and it is necessary that the current flow in the same direction in both of the layers. To accomplish this, touch the shellac brush to several

parts of the coil and wrap one piece of thin paper on top of the layer of wire. Bring the wire from the last loop straight across the coil and just under the end of the paper, after which apply a light coat of shellac to the paper and allow it to become nearly dry. Wind on another layer of wire, being very careful to proceed in the same direction as the winding of the first layer. The second layer consists of 25 turns, and no taps are taken. A small hole in the edge of the tube holds the end of the wire. Cut the wire 2" from this point. Next scrape the insulation carefully off the ends of the loops and off the beginning and ending of the winding.

Three strips of paraffin paper 8" by 1" and two strips of tin-foil 6" by $3/4$ " are needed for the condenser. A piece of $5/8$ " by 1" cardboard is used with each strip of foil. A 2" piece of the small wire, with insulation removed, is wrapped around the cardboard to make connection to the foil. There must be no possible contact between the wires or strips of foil inside the condenser. The foil strips and pieces of cardboard are separated by one of the paper strips, while the other paper pieces are placed one on either side. The condenser is then rolled up over the cardboard pieces and fastened with a touch of shellac.

The shank for the switch arm is a 6-32 brass machine screw. The switch arm itself is cut from spring brass or other metal and soldered to a 6-32 nut, allowing a hole for the screw. A washer is placed beneath the head of the screw, and the shank pushed up from the bottom of the panel through the hole in its center. The nut with the

arm soldered to it is screwed down snugly, and the rubber knob from a 6-32 binding post utilized both for switch knob and lock washer.

Place the coil under the panel with the row of loops under the holes prepared for the switch points. The beginning of the winding is pushed through the first small hole, a common pin pushed down past it, and the scraped end of the wire given two turns around under the head of the pin. Clip off the pin and bend over the stub with a pair of pliers. Bend it so that there will be no contact with the next pin. The loop next brought out from the coil goes in a similar way to the next switch point, and so on until 16 switch points have been connected. Try not to break the wire during this operation, since a twisted joint cannot be relied upon unless it is soldered. The cat-whisker is a piece of No. 26 or other light copper wire whose end is forced into the square opening in the inside end of the shaft of the winding stem of the watch. It is then bent in such a manner as to play through a hole located at one side of the stem. A small clip or piece of brass bent in the form of a clip is the crystal holder, and it is held to the panel by a small machine screw and nut.

The figure shows the schematic diagram of connections. It will be noticed that the watch case is employed for the ground. This is done in order to eliminate any body capacity effects which might detune the circuit when the tuning is being done with the watch held in the hand. The end of the winding is connected to the case, or to the cat-whisker, inside the case. One binding post is connected to one side of the condenser and to the switch arm beneath the washer, while the other post is wired to the other side of the condenser and to the crystal clip. The ground goes to the watch case, and the antenna to the binding post that is connected to the switch arm. The telephone receivers are connected to the binding posts. These should be of 2,000 ohms resistance or more. With a 100' aerial of a single wire, the set will tune in stations between 200 and 450 meters. The crystal adjustment is easily made with the aid of the watch stem in place of the usual ball and socket arrangement. A regular crystal mounting can be used, although this occupies too much space to be desirable. If the coil and panel do not fit tightly in the case, two or three pieces of cardboard may be placed back of the coil, and the case snapped shut.

Such a miniature receiver will operate nearly as well as any single circuit set of larger size, and is certainly highly portable and convenient. A rolled up aerial and pair of phones may be taken along on a hiking or automobile trip, and the outfit set in operation in a jiffy.

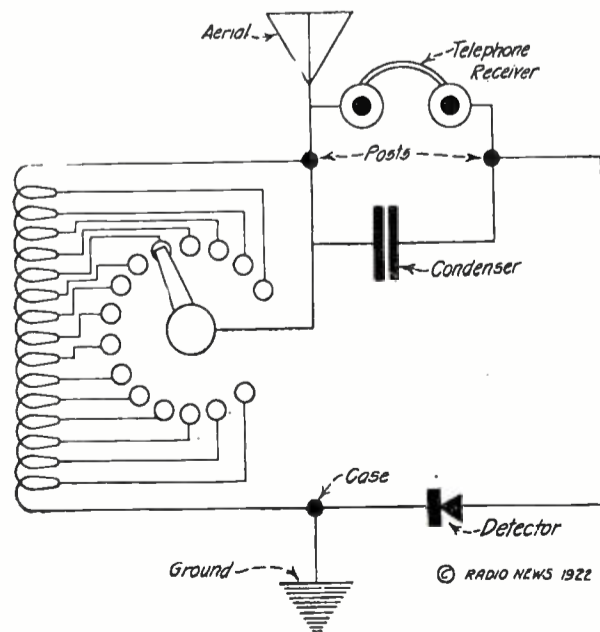

The Wiring Diagram of the Watch-case Receiver. A Wave-length Range of from 200 to 450 Meters Is Obtained.

Single Layer Inductances

By HERBERT J. SCOTT

WITHIN the last decade radio has become a very popular science, and one which has found many supporters and followers.

It seems to have the faculty of taking the newcomer firmly by the hand, as it were, and leading him on with an uncontrollable desire to construct apparatus of various types, and for various purposes, and to experiment with it when completed.

Many of those who desire to build their apparatus are often handicapped or held back, not because they do not know how to build the various pieces of apparatus from a mechanical viewpoint, but because they do not know electrically just what the values of the various parts should be. Sometimes, even knowing what these values should be, they do not know what size to build them in order to produce the desired effect when completed.

Frequently it is desired to construct apparatus which shall work over some predetermined band of wave-lengths. Here again comes the question of how large should the condenser be, or what value of inductance should be used, and how large a coil should be wound to produce the desired effect?

It is desired in this article to put before those who are anxious to know, a way in which this may be done.

In order that a circuit be resonant to a certain frequency, it is necessary that inductance and capacity be present in that circuit, in such proportions that,

$$2\pi fL = \frac{1}{2\pi fC} \quad (1)$$

When this condition is fulfilled, the capacitive reactance exactly equals and opposes the inductive reactance of the circuit. The total reactance is then zero and the power factor becomes unity. A maximum flow of current then takes place in the circuit.

When considering radio circuits, however, it is more convenient to think in terms of wave-length than frequency. These are related in the following manner:

$$\lambda = \frac{V}{N} \quad (2)$$

where, λ =wave-length
 V =velocity of propagation
 N =frequency.

For a circuit to be resonant to a certain wave-length, its constants L and C must bear the following relation to one another:

$$\lambda = 1884\sqrt{LC} \quad (3)$$

or in terms of L ,

$$L = \frac{\lambda^2}{(1884)^2 C} \quad (4)$$

or in terms of C ,

$$C = \frac{\lambda^2}{(1884)^2 L} \quad (5)$$

where, C =capacity in microfarads.
 L =inductance in microhenries.
 λ =wave-length in meters.

Remembering these conditions, let us now suppose we desire to construct an inductance which, when shunted by a variable capacity whose maximum capacity is 0.001 mfd., will enable us to tune to resonance at a wave-length of 2500 meters. Then by (4)

$$L = \frac{(2500)^2}{(1884)^2 \times 0.001} \quad (6)$$

solving,

$$L = 1760 \text{ microhenries} \quad (7)$$

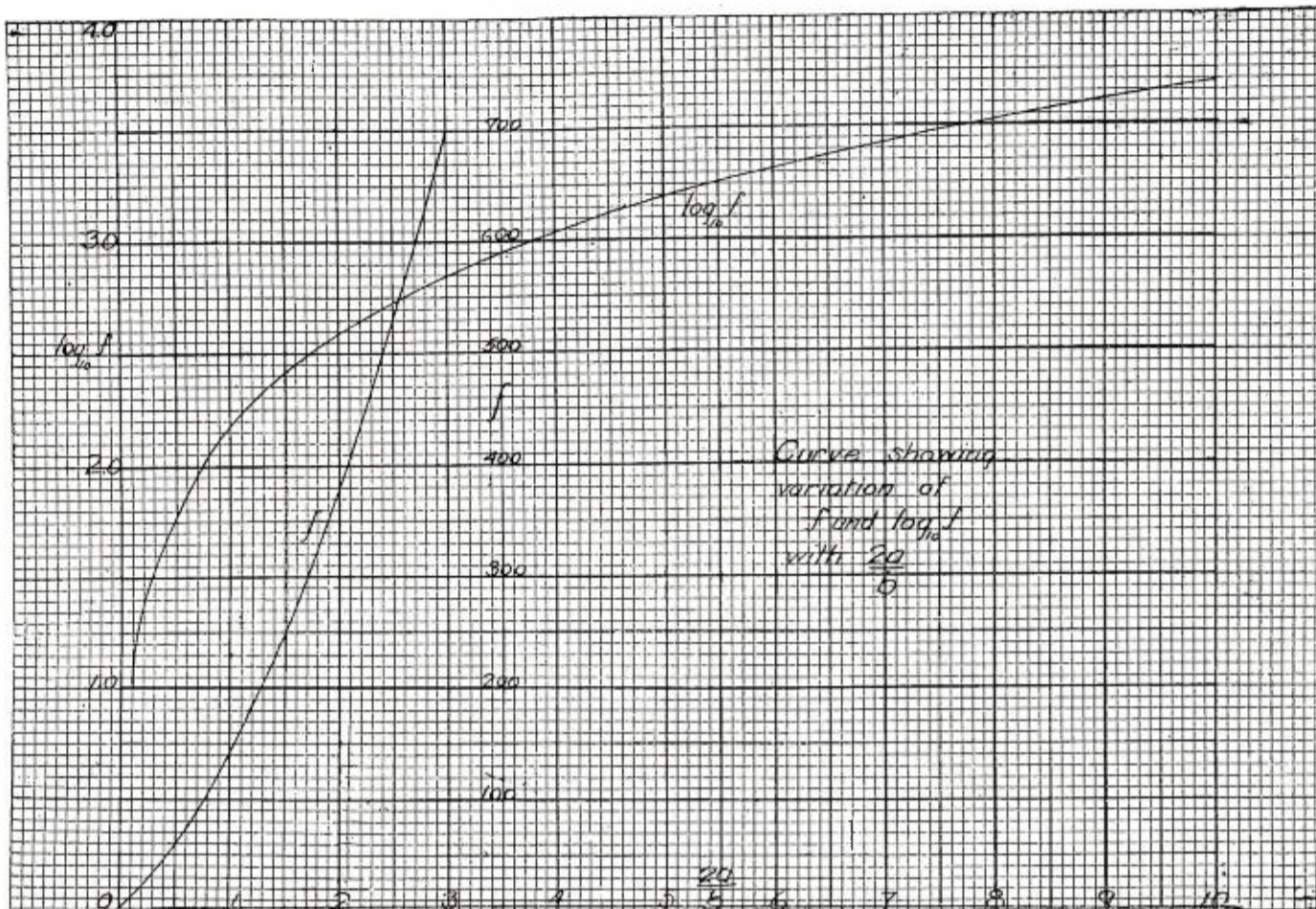

By Means of This Chart, the Constant Used in the Calculation of Inductance May Be Determined

A maximum value of 0.001 mfd. was chosen because the most readily obtainable, and popular, variable condensers on the amateur market have a maximum capacity of about 0.001 microfarad.

Since we now know the value of inductance required, let us determine the size of the coil and the kind of wire it is to be wound with, and the number of turns necessary.

The first step is to decide upon the diameter of our winding. This being somewhat optional, we will choose a diameter of three inches. After deciding on the diameter it is next necessary to consider the size of the wire to be used in the winding. This also being optional, let us choose a convenient size such as No. 24 D. S. C.

Referring to Table IV, which gives the number of turns per inch of various sizes of wire, we find opposite No. 24 and under the column headed D. S. C., the number 41.5. This means that there are 41.5 turns per inch of winding of No. 24 D. S. C. If we take

41.5 we have the pitch of the winding expressed in centimeters, or 0.061 cm.

The most convenient formula for use in determining the inductance of a single layer coil, is that given by Nagaoka, in which,

$$L = \frac{a^2 n^2}{4\pi^2 b} K \times 10^{-3} \quad (8)$$

where

- L =inductance of the coil in microhenries.
- a =radius of the coil in centimeters.
- b =length of winding in centimeters.
- n =number of turns.
- K =constant depending on the ratio of $\frac{2a}{b}$

for its value, which may be found in Table I. Since, however, we do not know the length of the winding or the number of turns, but do know the total value of inductance, and the radius of the coil, it is necessary that this formula be rearranged before it can be applied to our case. The values we must calculate are the values of n and b . Now $n=b$

where n and b have the same values as in (8)

and D is the pitch of the winding in centimeters. Let us then substitute the equation

$b = D$ for its equal n . The equation (8) then becomes,

$$L = \frac{a^2 b^2}{4\pi^2 b D^2} K \times 10^{-3} \quad (9)$$

or

$$L = \frac{(2a)^3 \left[\frac{\pi^2 b K}{2a \times 10^3} \right]}{D^2} \quad (10)$$

and

$$\frac{LD^2}{(2a)^3} = \frac{\pi^2 b K}{2a \times 10^3}$$

from this

$$\frac{2a^3}{LD^2} = f \quad (11)$$

where

$$f = \frac{\pi^2 b K}{2a \times 10^3} \quad (12)$$

We know that,

$$2a = 3 \text{ inches} = 7.62 \text{ centimeters} \quad (13)$$

$$D = 0.061 \text{ centimeters} \quad (14)$$

$$L = 1760 \text{ microhenries} \quad (15)$$

then substituting in (11)

$$\frac{(7.62)^3}{1760 \times (0.061)^2} = f \quad (16)$$

or

$$f = 67.56 \quad (17)$$

$$\log_{10} f = 1.829 \quad (18)$$

hence

$$\frac{2a}{b} = 0.55 \quad (19)$$

(See curves for values of $\frac{2a}{b}$ with respect to f and $\log_{10} f$)

and

$$b = \frac{2a}{0.55} = \frac{7.62}{0.55} = 14 \text{ centimeters} \quad (20)$$

$$n = \frac{b}{D} = \frac{14}{0.061} = 229 \text{ turns} \quad (21)$$

(Continued on page 270)



Practical Information on Reception of Radio Signals*

By B. BRADBURY†

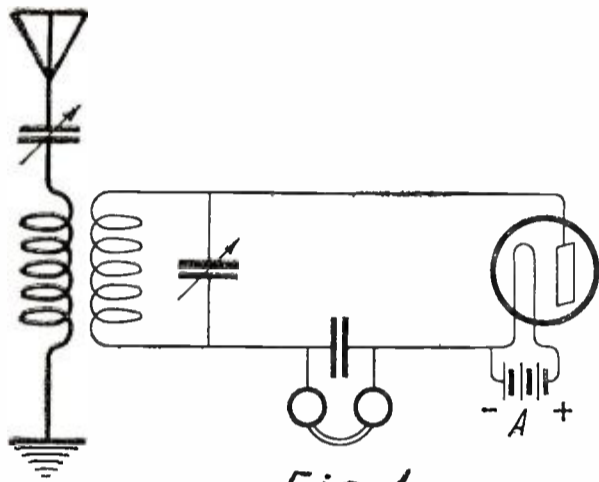

Fig. 1

This Diagram is of a Fleming Valve, the Simplest Vacuum Tube Rectifier.

WE have seen that the purpose and usefulness of the detector is to convert the received current of high frequency into direct current which is necessary to operate telephone receivers. Various forms of detectors which accomplish this end have been used in the past including the original coherer, the magnetic detector, the electrolytic detector, the crystal detector and the vacuum tube detector. All of these except the last two have become obsolete and these two are the only ones in common use today.

We have previously seen that the crystal detector makes audible the high frequencies of incoming signals because it rectifies them; or in other words, allows current to pass in only one direction. The rectified current consists of a series of pulsations which pass through the windings of the telephone receivers and cause the diaphragms to vibrate at a frequency which, in the case of radio-telephone signals, would correspond with the tones of the music or voice being sent out. We have also seen that for long distance reception a detector having more sensitive and stable characteristics than the crystal type is very desirable. These desired features are embodied in detectors of the vacuum tube type.

The simplest form of vacuum tube detector acts as a rectifier in much the same way as does the crystal, as in Fig. 1. In order for the tube to rectify it must allow passage of the received alternating current in one direction and prevent the passage of current in the opposite direction. To bring about this result it is obvious that something must be done to lower the resistance of the tube, for current flowing in one direction and to keep the resistance high when the

current tends to reverse. The two metallic parts, or electrodes, are securely sealed into the glass tube and the tube is then pumped out until it is almost entirely free from air. One electrode, the plate, is generally formed of thin sheet metal, while the other, known as the filament, is made of small wire and has both ends brought out through the glass. By connecting the two ends of the filament to a battery, A, of suitable voltage, it can be heated by the battery current to a temperature which will cause it to glow brightly. When the filament is thus heated, the space between it and the plate becomes a conducting path for the flow of current if the voltage on the plate is positive, but the high resistance is maintained to prevent the flow of current if the voltage on the plate is negative. In this way, as with the crystal, a pulsating current is produced which vibrates the telephone diaphragm and produces sound.

The sensitiveness of the vacuum tube is greatly increased by the use of a third electrode, called the grid, which is essentially a metallic screen of fine mesh. This screen is placed between the filament and the plate as in Fig. 2 and its function is to control the flow of current from plate to filament through the telephone circuit. It will be seen that besides the A battery for heating the filament, there is also a second one, commonly called the plate battery, or B battery. This is connected in series with the telephone receivers, so that the positive terminal is next to the plate and the negative terminal is next to the filament. When connected in this way there is a steady flow of current from the B battery through the tube. This current can be controlled by applying a small voltage between the grid and filament. When the voltage on the grid is negative, it has the effect of decreasing the current in the telephone circuit, and when the grid voltage is positive it allows the plate current to increase. In this way the feeble alternating current of an incoming signal can be applied to the grid and filament and used to control the flow of direct current from the B battery through the telephone receivers. Thus the effect of the signal is multiplied through

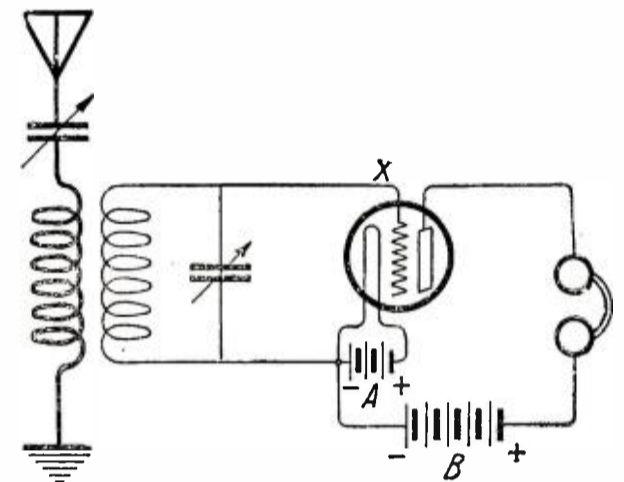

Fig. 2

Connections of a Three-Electrode Vacuum Tube in a Receiving Circuit.

the relay action of the tube and produces considerably greater action of the telephone receivers than could be obtained by simple rectification as previously described.

With tubes as designed for common practice the sensitiveness of operation is greatly increased by inserting a small condenser in parallel with a high resistance in the grid circuit as at X. The actual phenomena taking place within the tube are then somewhat different from what they were without the condenser, but the action on the telephone is fundamentally the same in that the current from the B battery is made to rise and fall on account of the feeble impulses of the received signal.

Vacuum tubes can also be made more sensitive by admitting certain gases into them during the process of manufacture. The presence of the gas causes a greater change in the telephone current with a signal of given strength and thus produces stronger vibrations of the telephone diaphragm.

Before leaving the subject of the detector it will perhaps be well to consider some of the details which must be observed in order to secure efficient detection and thereby obtain the best signals.

Referring to Fig. 3, we have a vacuum tube circuit arranged for simple detection.

In order to operate such a circuit with good results it is necessary to know the values of the different electrical constants.

We have previously seen that a detector tube consists essentially of three elements, a filament, grid and plate, enclosed in a glass bulb which has been evacuated. The filament is lighted by the "A" battery to a bright red heat, and when thus lighted gives off an electron emission which serves as a conducting path for the "B"

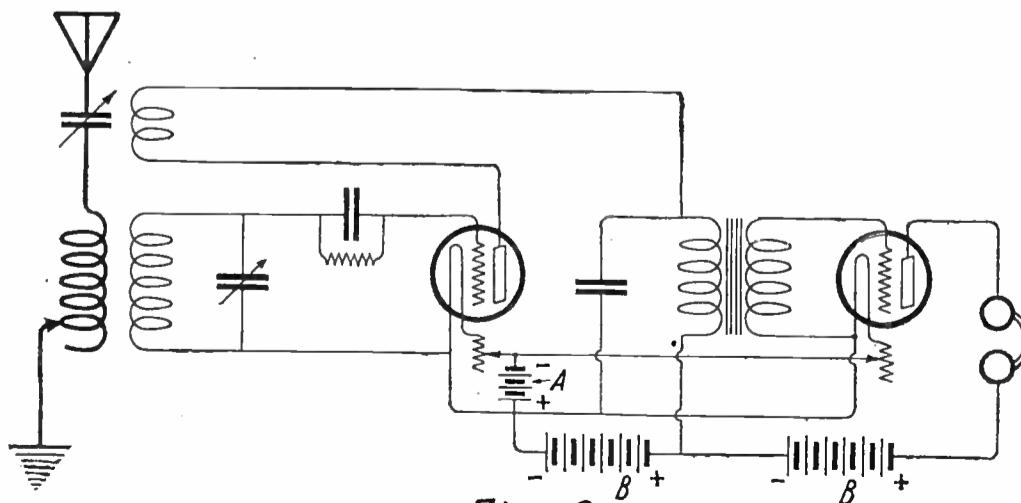

Fig. 6

Diagram of Connections for a Receiver with Vacuum Tube, Detector and Amplifier.

*Continued from the July issue of RADIO NEWS.

†Radio Dept. General Electric Co.

(Continued on page 290)

Awards of the \$50 Radio Wrinkle Contest

First Prize

TELEPHONE CORD TIPS AND WIRE TERMINALS FROM BICYCLE SPOKES
By ARTHUR WORISCHEK

Small radio parts are often difficult to obtain and this is especially true of telephone cord tips, which are supposed to be in production but really have not been available for months. Such tips are not limited to application as terminals for head phone cords, but they are eminently suitable as wire terminals for the Fahnenstock type of binding post used on "B" batteries and for use with the miniature switchboards which are lately finding so much favor.

A very substantial and decidedly neat looking tip or terminal may be made from the common bicycle spoke. Such spokes cost from one-half cent to two cents apiece, complete with nipple. Packages of a dozen or a hundred may be obtained at even lower prices, as they are a staple article in the trade. A constant source of raw material is thus available. The parts are absolutely uniform and accurately machined. The assembly of the cord and tip parts is but the work of a minute.

The cut clearly shows the construction. A represents the first step. The threaded shank is roughly clipped into lengths convenient for handling. B shows the shank trimmed for use: part of the threaded portion is clipped off; the other end may be left as long as desired. C shows the cord with its insulation trimmed down and the wire beaded to fit into the nipple D. The part of the cord nearest the exposed end of the wire should preferably be shellacked to prevent fraying and for the further purpose of insuring adhesion to the interior of the nipple when heat is applied during soldering.

Assembling is very simple. The cord C is inserted into nipple D. At the same time E is screwed into the other end. During this insertion of E, soldering fluid and solder are applied with heat to the threads and both E and the wire end of C are "sweated" into place in the nipple D.

By merely combining D and E (without cord) we have of course the ordinary form of tip costing from ten to fifteen cents—and unobtainable at present.

The cheapness of the raw material and fine appearance of the finished article should commend it as an item for home manufacture by amateurs.

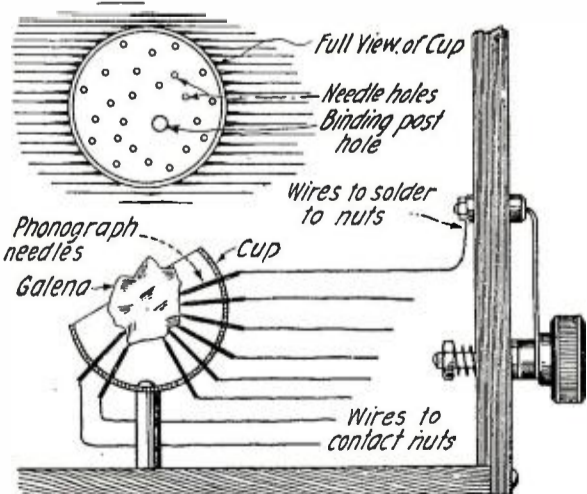

If One of the Sensitive Spots of This Type of Detector Becomes Dislodged Another Can Be Easily Found by Turning the Switch Lever.

The writer has not yet tried using motorcycle spokes and wire wheel auto spokes as substitutes for heavy current terminals but suggests this as a possibility.

Second Prize

"A TWO IN ONE"
By BERNARD SALZBERG

This is a novel method of obtaining both a shielded and vernier effect by one instrument. With this shield and mechanical vernier a micrometer adjustment is possible and

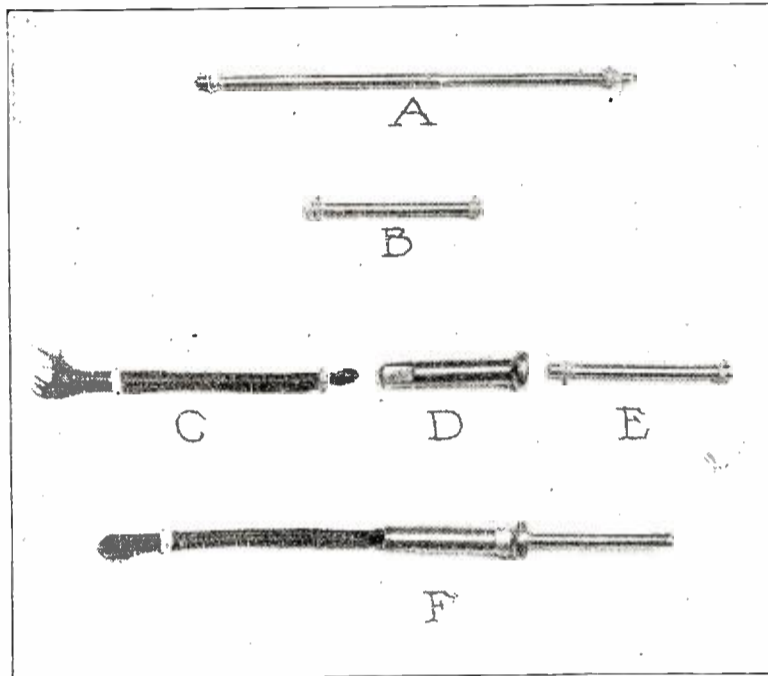

The Prize Winning Suggestion of a Method to Adapt Bicycle Spokes as Telephone Tips. Full Details Are Given in the Accompanying Article.

PRIZE WINNERS

FIRST PRIZE, \$25

Mr. Arthur Worischek,
1405 "G" Street, N. W.,
Washington, D. C.

SECOND PRIZE, \$15

Mr. Bernard Salzberg,
308 East 101st Street,
New York, N. Y.

THIRD PRIZE, \$10

Mr. C. E. Ackerman,
76 Somerset Street,
N. Plainfield, N. J.

all body capacity is eliminated. It is easy to construct and is well worth the small outlay of money necessary.

An ordinary dial is given a thin coating of shellac and an aluminum leaf, cut so as not to come in contact with the shaft, is pressed down upon it. If the constructor possesses a metal dial which does not come in contact with the shaft, the above operation is unnecessary.

The vernier consists of an ordinary eraser obtained from the end of a pencil, a knob, a circular piece of aluminum cut from a No. 22 B. & S. aluminum sheet, a flat-head screw and a brass support, preferably nickelplated, of the shape shown in diagram. The different parts are put together and the support is grounded.

Third Prize

PERMANENT CRYSTAL DETECTOR
By C. E. ACKERMAN

The crystal detector illustrated in the accompanying drawing will be found extremely practical and very convenient. Usually one of the chief drawbacks of the crystal detector is the difficulty in keeping it in adjustment. A catwhisker may easily be dislodged from the sensitive spot by static or when a transmitter is operated in the neighborhood. When this happens, it is necessary with the ordinary type of detector to readjust the catwhisker and find another sensitive spot. This constant need for adjustment is the feature which makes the crystal an undesirable method of detecting radio signals.

The type of detector suggested by the drawing eliminates this feature. Any number of catwhiskers, in the shape of phonograph needles, may be brought to switch points on the front of the panel. If one of the sensitive spots becomes dislodged, another can be easily and quickly found by turning the switch lever.

The constructional details of this detector are clearly indicated in the illustration. Phonograph needles pass through holes in the detector cup and support the crystal. The ends of the needles are wired to the contact points on the front of the panel.

DIFFERENT TYPES OF CRYSTALS

Detectors using galena or lead-sulphide are almost entirely used today to the exclusion of other kinds of crystals. Although galena is more sensitive, it is considerably more difficult to keep in adjustment. Some other kinds of crystals are easier to adjust even though they are not quite so sensitive. Galena or lead-sulphide require a very slight pressure of the catwhisker.

Another type of crystal detector is one which combines the rectifying effects of two different crystals; one of bornite and the other of zincite. The bornite crystal takes the place of the catwhisker. With this arrangement it is invariably possible to find a sensitive spot quite easily.

Another form of crystal detector is one which utilizes carborundum. This is not so sensitive, but is very stable in operation; a rather heavy contact is used and an ordinary steel phonograph needle mounted on the detector-arm is employed. The sensitive spot in the carborundum crystal is found by jabbing the point in various spots until the loudest response is obtained.

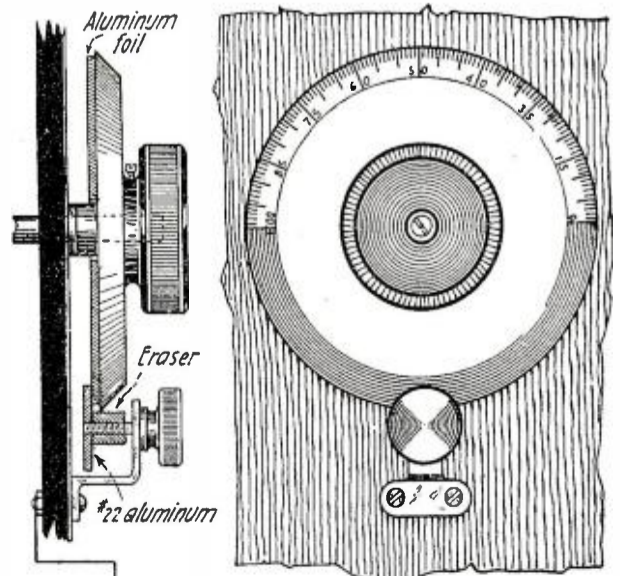

A Novel Method of Employing a Dial and Vernier as a Body Capacity Shield.

Practical Hints for Amateur Constructors

A VARIOMETER FOR TWENTY-FIVE CENTS

I recently made a variometer for less than twenty-five cents. It was made with two paper toy balls at five cents each, some No. 26 wire, two brass screws, four nuts and a strip of brass 8" by 1". The whole expenditure was really the price of the two balls as the other articles were odds and ends. The diameter of the small ball is about 3" and of the other, about 3 1/2". Each is wound with +8 turns of wire. The outer, or stator, is wound clock-wise and the inner, or rotor, is wound anti-clock wise. The small ball is wound first. The wire is started through a hole punched in the edge, as shown in the illustration. The first turn is kept in place by running a sharp knife around the ball and raising up an edge. The two screws are then put in place, the nuts clamping the ball firmly to allow for turning. A knob can be put on an extension fitted to the same screw, making an up-to-date finish for mounting. The two halves of the larger ball are put over the small one and holes made in the center of each half for the rotor screws. A small strip of paper glued to the edges will hold the two halves together. The winding can then be put on. The stand was made of 1" brass

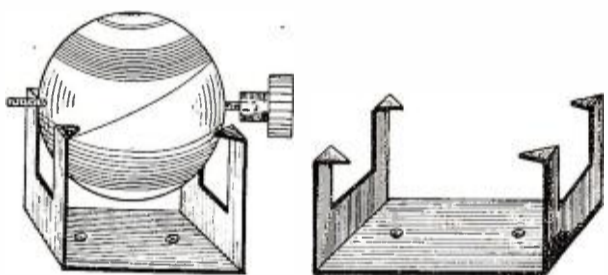
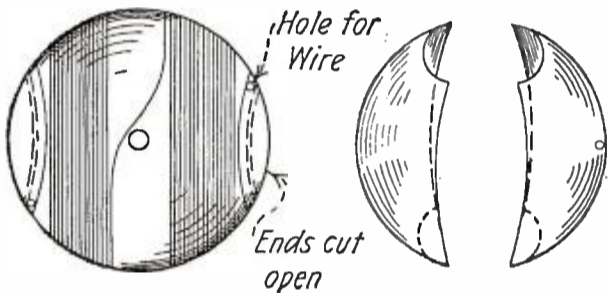

A Simple Variometer Can be Made from Two Paper Toy Balls. The Total Cost of This Variometer is About Twenty-Five Cents.

strips turned up as shown and the ends made into prongs to pierce the outer ball just enough to hold it firmly.

Contributed by L. ALBUM, Everett, Mass.

THE RENEWAL OF V. T. FUSES

It is possible to renew blown-out V. T. fuses quite easily. Cut a strip of tinfoil measuring 3/4" by 1/16", insert one end of the strip into the open end of the deceased fuse and slip it on the pin of the V. T. holding the tinfoil in place. Then fold the other end of the tinfoil down, and over the bottom of the fuse and insert the bulb in the socket. The prong of the socket will hold the other end of

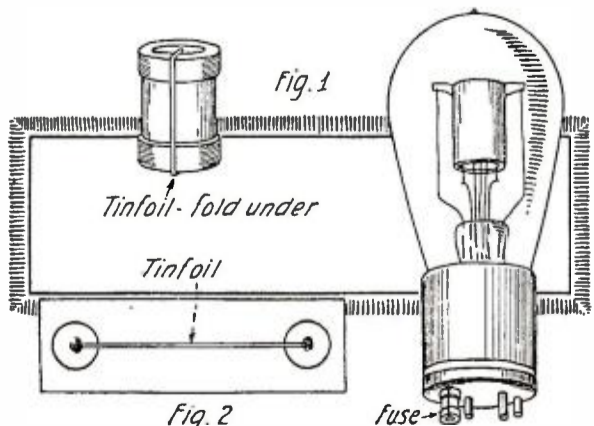

Blown-Out V. T. Filament Fuses Can Be Renewed with Tinfoil or a Fuse Constructed by Connecting a Piece of Tinfoil Between Two Binding Posts.

the tinfoil in place. These fuses will function as satisfactorily as the original product and are variable, since, the wider the tinfoil, the greater the capacity, and vice versa.

It is also possible to construct a fuse for a V. T. by connecting the ends of a strip of tinfoil to binding posts and connecting it in series with the filament of the V. T.

Contributed by WESLEY PETERSON, Geneseo, Ill.

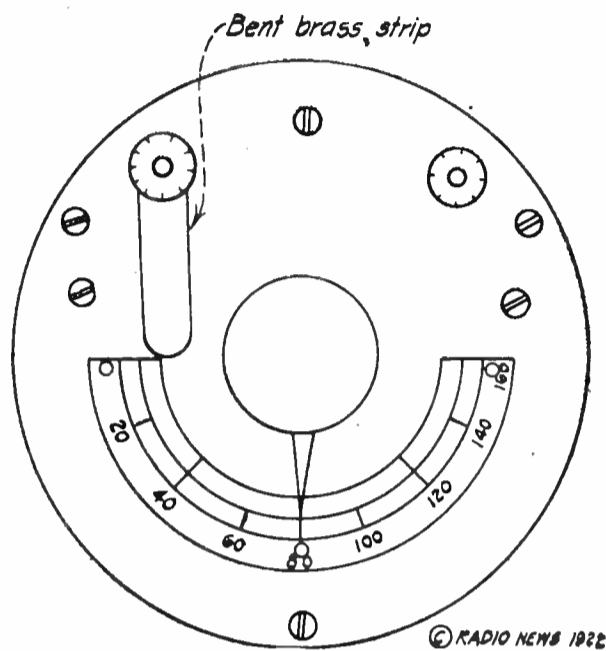

By Connecting a Bent Brass Strip to the Binding Post of the Stationary Plates of a Murdock Condenser the Latter is Shorted in the Zero Position.

SHORTING A MURDOCK CONDENSER

From the sketch may be seen a simple method of cutting out a Murdock condenser at the zero position. This does away with an off-and-on switch and the inconvenience of taking the hand off the condenser. It in no way interferes with the working properties of the condenser. A bent brass strip is slipped over the binding post of the stationary plates and fastened in such a way that when the pointer swings around it makes contact.

Contributed by STEPHEN R. CHESTER, Tacoma, Washington.



Nut and Screw taken from Battery

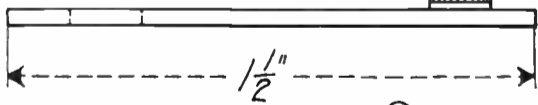

© RADIO NEWS 1922

This Little Connector Permits Two Connections to be Brought to One Binding Post Without Any Trouble.

A USEFUL CONNECTOR

Very often it is difficult to connect two wires to one binding post. This little connector shown in the illustration will make it easy. The connector is made of brass 1/16" thick, 1 1/2" long, and 5/8" wide at one end, tapering to 1/4" at the other end. At the widest end, a 3/16" hole is drilled to receive the shank of the binding post. At the narrow end, a small brass machine screw, taken from the zinc of a dry battery, is soldered, and a brass nut, also taken from a dry battery, is screwed on. This completes the connector, which, in itself, is very simple. The accompanying illustrations make its construction

very clear. When this little appliance is fastened under a binding post, it makes a positive contact, due to the pressure on the two metals. It is also very useful when building stationary spark gaps, crystal detectors, holders for audiotrons, etc., where there are two wires leading to one binding post; a better connection is obtained than by merely tightening the binding post down on the wire itself.

Contributed by PERCY R. PARKER, Malden, Mass.

CONSTRUCTION OF A V. T. SOCKET

This socket may easily be made by any amateur. The base is composed of sheet formica 3x2 1/4 x 1/4". Holes are drilled in each corner of the base and four binding posts mounted. Four other holes (3/32") are drilled in the middle of the base in the form of a square, the holes being 1/2" from each other. In these holes, brass tubes, measuring 1/4" by 3/32", are inserted, to take a standard four-prong vacuum tube. The tube of the socket is a piece of bakelite tubing 1 3/8 x 1 5/8" high. Two holes are drilled and tapped at one end of this tube and two machine screws, passing through corresponding holes in the base, screw into these tapped holes and hold the tube in position. By means of a file, a slot is cut at the top of the tube to permit the projection on the side of the bulb to pass.

Contributed by J. R. SECREST, JR., Raleigh, N. C.

© RADIO NEWS 1922

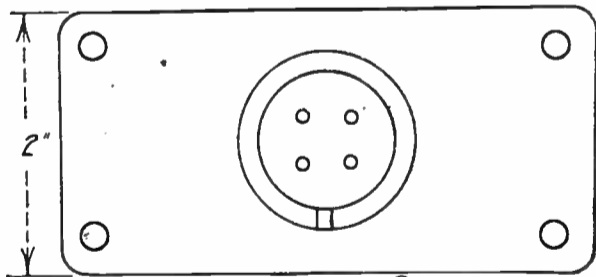
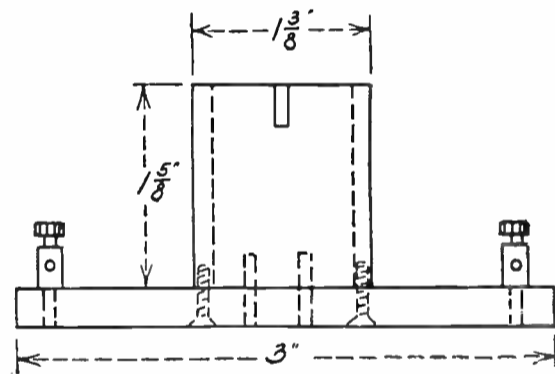

© RADIO NEWS 1922

This Drawing Indicates the Plan and Elevation of a V. T. Socket Which May Be Constructed by Any Amateur. The Measurements Are Given.

AUTOMATIC FILAMENT SWITCH

This is for the fellows who use a D. P. D. T. switch to change from sending to receiving.

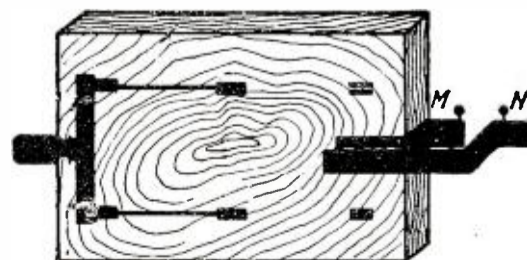

© RADIO NEWS 1922

This Little Device on the Change-Over Switch Opens the Filament Circuit of the Receiver While Transmitting.

Bend two strips of spring metal about 1/4" wide as shown. Fasten these pieces to the panel or table at either end of the switch as indicated in the diagram.

Connect the two strips either in series with the filament of the tube or in series with the primary of the transformer and spark coil. When the switch is closed it will press the pieces of metal together, closing the circuit.

Contributed by DONALD H. ROSS,
Lewisburg, Pa.

HIGH VOLTAGE FOR I. C. W. FROM A SPARK COIL

For the man who has no city current supply, I shall try to explain a cheap method of

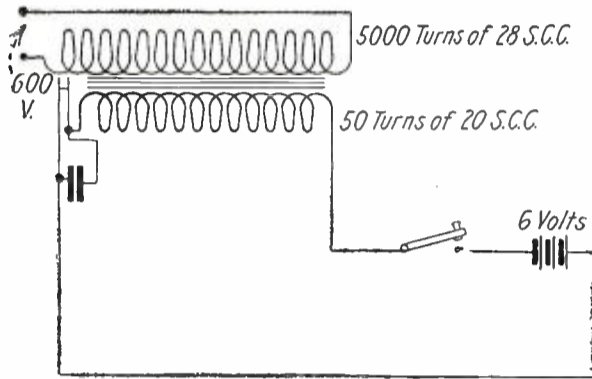

High Voltage for a C. W. Set Can Be Obtained from a Ford Coil and Better Results Obtained If It Is Rewound as Shown in This Diagram.

obtaining a high voltage for the plate of the C. W. set.

Many people have advised a Ford coil. While this works very well a better source can be obtained just as cheaply. It is understood that a spark coil is wound to give an enormous voltage. Now why not build one which will give the right voltage? One can be made easily as follows:

Procure a Ford coil and dismantle it. Wind 50 turns of number 20 S. C. C. on the core. Bring the leads out on each side. Then wrap a single layer of empire cloth over the primary. Wind 5,000 turns of No. 28 S. C. C. over the empire cloth. The leads from this secondary, when 6 volts are used on the primary, give 600 volts. The primary is connected, as it was originally, to the vibrator and the other leads are connected as shown in the diagram. This voltage furnishes enough amperage for several tubes. I. C. W. is used here with one E. tube. It was found that the circuit on page 500 of December RADIO NEWS worked very well.

Contributed by WM. W. KOCHERSPERGER,
Philadelphia, Pa.

COMBINED INDICATOR AND SHIELD

The accompanying drawing is of a simple combined dial indicator and body capacity preventer to be used on metal indicating dials. It consists of a piece of spring brass

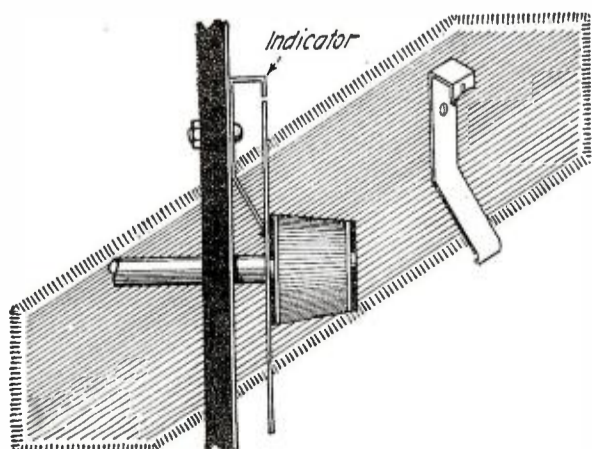

By Grounding This Indicator Which Rubs Against the Inside of the Dial, Body Capacity Effect Is Eliminated.

bent in the shape shown with one hole drilled through it to allow a bolt or screw for fastening to panel. The lower part of the indicator is bent to scrape on the dial. The bolt passing through the indicator and panel is grounded and the indicator grounds the dial. The dial should have an enlarged center to prevent it from touching the shaft. Both indicator and the part of the dial with which the indicator comes in contact should be sandpapered.

Contributed by NATHAN LEYSU,
9DGN, Minneapolis, Minn.

LOOSE-COUPLER WITH DEAD-END SWITCH

There is a certain amount of current in the unused balance of the primary coil of a loose-coupler which is not in resonance with the antenna, which is not only a total loss in the secondary circuit, but which acts to retard the secondary circuit and signals in the receiver. By means of the dead-end switch, as shown in the accompanying sketch, any portion of the unused coil may be cut entirely out of the circuit. The unused twins are short-circuited by means of the circular disc switch, thereby permitting a much better tuning arrangement with increased volume of sound. By opening the single pole knife switch, indicated in accompanying drawing, the unused portion of the primary coil from the antenna circuit is disconnected. The

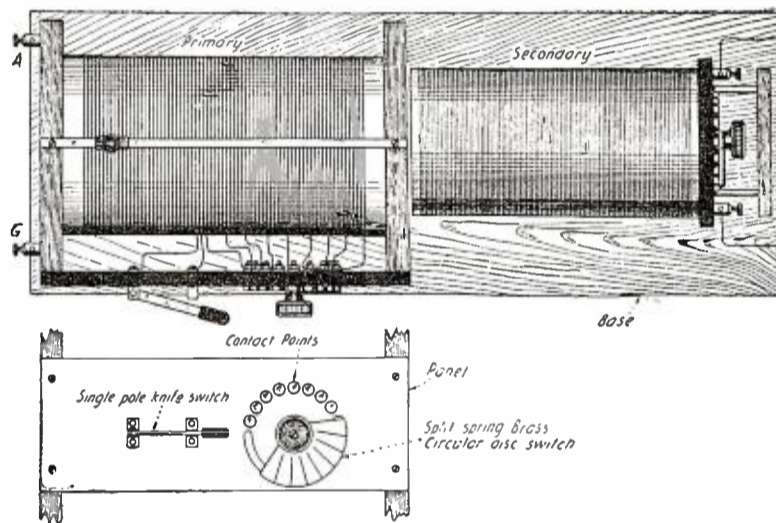

The Dead-End Switch on This Loose-Coupler Prevents Losses from Distributed Capacity.

latter may then be used as a regenerative feed-back or "tickler" coil as sometimes required for audion reception.

With a coil of this kind any desired wave range may be obtained from 200 to 2,000 meters by simply varying the number of turns of wire out into the circuit with the circular disc switch. The minimum number of turns to be wound on the coil prior to tapping in the single pole switch would be fifty-five. This permits the reception of signals from transmitting stations of 400 meters and less. For reception of signals of over 400 meters wave length, the minimum number of turns should be 150. Taps should be taken from the remainder of the coil at intervals of approximately every twelve or fifteen turns, and fastened securely to the contact points of the circular disc switch.

Contributed by FRANK J. MULDER,
Washington, D. C.

A PHONE BINDING POST KINK.

The accompanying sketch shows how the writer uses a hard rubber top binding post for telephone connection. A good many people prefer a binding post of this type, but the cord tips ordinarily supplied on phones are hard to grip in these posts.

By simply filing a groove across the brass base as shown, to a depth equal to about one-half the diameter of the cord tip, these posts work fine with phones.

If desirable to hook two sets of telephones in parallel use two double grooved posts, connecting one side of each headset to each binding post. To connect two headsets in series, use three posts, the two outside posts, only, being connected to the inside wiring. To use one headset on this arrangement it can be connected across the outside posts.

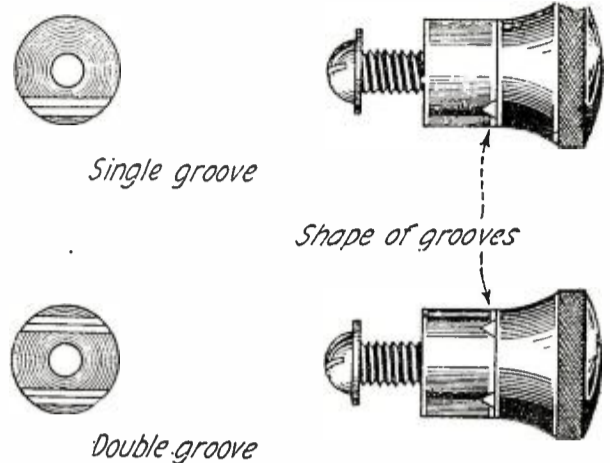

If Binding Posts Are Filed in This Manner, Telephone Tips Can Be Inserted.

It is obvious that any number of headsets could be connected in series by adding double grooved binding posts.

Contributed by LLOYD B. GANGAWERE,
Dunbar, Pa.

VERNIER MADE WITH ERASER

The sketch shows a simple vernier attachment which I devised. At present, similar models are retained for \$1.50. This one cost me 45 cents for a panel switch and 5 cents for the eraser. An attachment of this kind is of great assistance in obtaining fine adjustment of the condenser, tickler, etc., while tuning in C. W. signals and phone.

In assembling this attachment, all the parts are taken off the rotor panel switch leaving only the knob and shank screw. The eraser is then slipped on and placed flat against the knob. A threaded nickel washer, which is supplied with the switch, is made secure against the rubber eraser and these parts are slipped through a hole under the dial for which vernier adjustment is required. The exact

spot for the drilling of the hole must be calculated and a little "accurate" guesswork is necessary. When the parts are pushed through, the metal bushing is tightened close to the panel and a small spring is put on

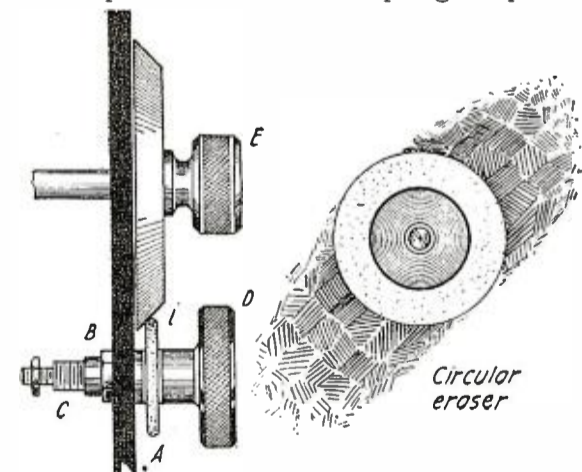

An Ordinary Typewriter Eraser Can Be Adapted to Serve as a Dial Vernier.

with a small nut (or two) bearing against it. The tightening or loosening of the nut regulates the tension necessary for fine functioning. Pressure on the dial must not be too heavy.

I am sure that radio enthusiasts will appreciate this device, for it is reasonable in price and gives fine service. I have been using a few of these vernier attachments with success on my set.

Contributed by I. KORENMAN,
Brooklyn, N. Y.

Combination Radio Cabinet and Table

By PHILIPPE A. JUDD

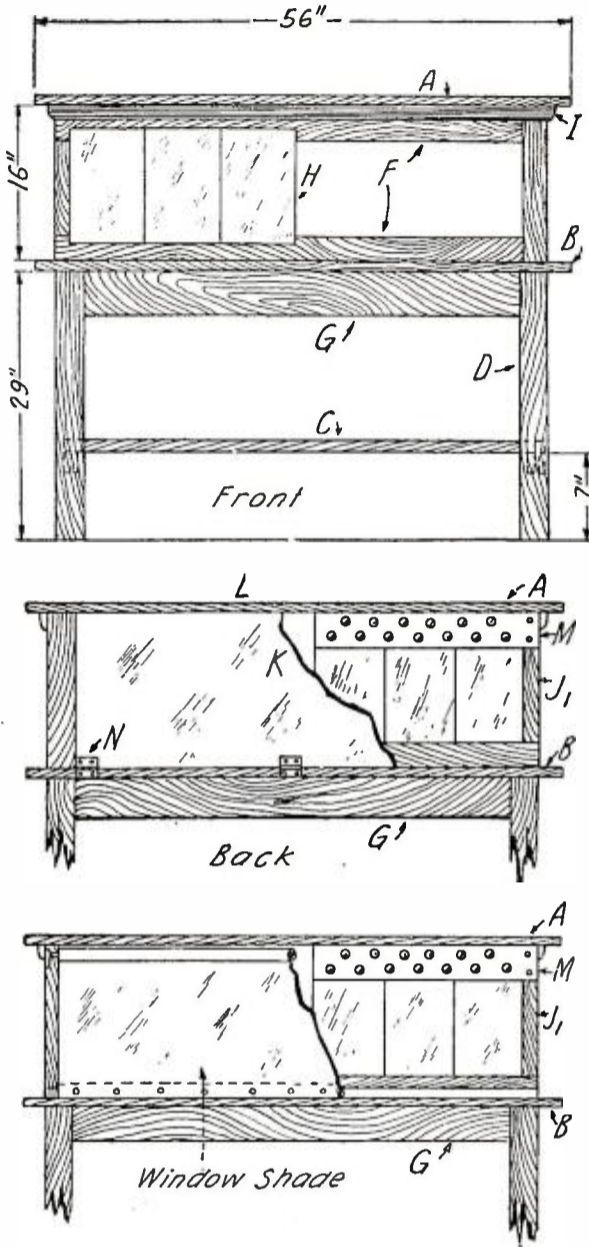

On the Left Are Front and Back Views of the Cabinet Showing Method of Mounting the Bakelite Panel and the Convenient Back Connections. On the Right, Two Methods of Finishing the Back Are Shown.

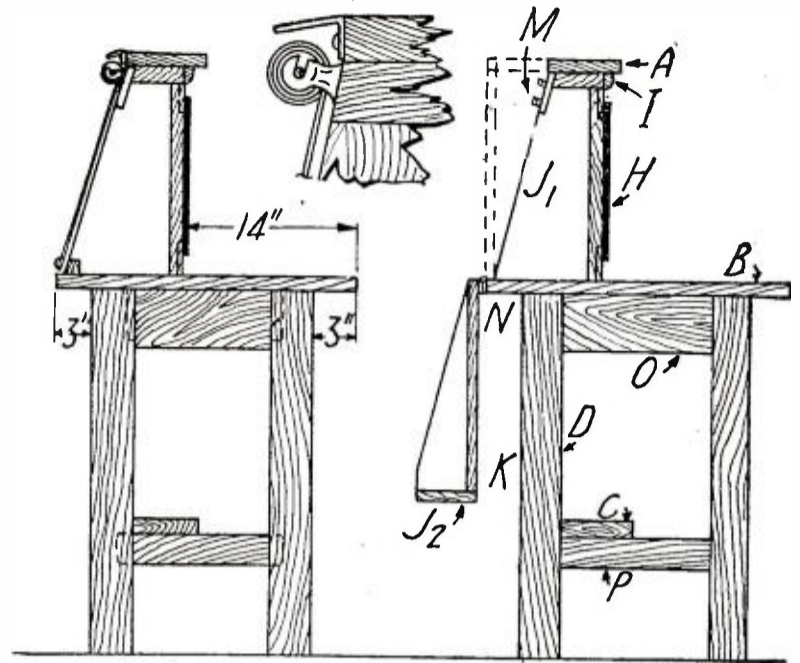

the cabinet, leaving the panel free of wiring. To those who use this type of instrument and who wish to experiment with various circuits; a table like the one illustrated is a great convenience.

The table may be constructed of soft wood, although a hardwood top is preferable. Constructional details are shown in the drawings.

The following is a list of the material required with the corresponding letters indicated in the diagram to show where they are used:

- A.....56 in. x 7 in. x 1 in. 1 piece, oak.
- B.....56 in. x 12 in. x 1 in. 2 pieces, oak.
- C.....49 in. x 6 in. x 3/4 in. 1 piece, oak.
- D.....29 in. x 3 in. x 3 in. 4 pieces, oak.
- E.....16 in. x 2 in. x 1 in. 2 pieces, oak.
- F.....50 in. x 3 in. x 1 in. 2 pieces, oak.
- G.....46 in. x 5 in. x 1 in. 2 pieces, oak.
- H.....12 in. x 8 in. x 1/4 in. 6 pieces, bakelite.
- I.....6 ft. 1 in. 1/4 round moulding.
- J₁-J₂...16 in. x 10 1/4 in. x 1 in. 2 pieces, oak.
- K.....50 in. x 4 in. x 1 in. 4 pieces, oak.
- L.....50 in. x 5 in. x 1 in. 1 piece, oak.
- M.....50 in. x 3 in. x 1/4 in. 1 piece, bakelite.
- N.....3-2 1/4 in. x 1 1/2 in. brass hinges.
- O.....14 in. x 5 in. x 1 in. 2 pieces, oak.
- P.....14 in. x 2 in. x 1 1/4 in. 2 pieces, oak.

On the bakelite strip M are mounted the binding posts for the connections.

Two methods of finishing the back are shown. In one case a window blind is used to cover the back of the cabinet while the other method employs a hinged wooden back, which may be secured with either a lock or hooks and screw eyes. The table may be finished with any desired stain or enamel.

At the front one large bakelite panel or the unit arrangement may be used. It is possible to materially reduce the constructional cost by substituting thoroughly seasoned oak for bakelite.

The table should be placed with an end to the wall, giving access to either side.

MOST amateurs give little attention to the table or bench on which their radio apparatus is mounted, generally using any convenient table placed against the wall. This makes access to the back of the instruments very awkward. Some of the latest apparatus has terminals at the back of

Soldered Connections

By F. MARTINDELL

MOST radio experimenters are well aware of the unreliability of binding posts and such devices, in obtaining secure connections, and of the desirability of soldering all joints.

The soldering of wires to various types of terminals and in restricted space is not easy unless the proper method is understood, and after a few experiences with burned fingers, the average experimenter is quite liable to give up and go back to unsoldered splices and screw binding posts in spite of their disadvantages.

This article proposes to give a few hints on how to solder some typical connections.

The first essential for successful soldering is a proper iron. The head should be made of solid copper forged between the split end of the iron handle, and the wooden grip should be large enough to fill the hand comfortably. The iron should be substantially made if good work is expected. Fig. 1 shows the proper size and shape.

Rosin is the only flux that should be used on electrical connections. It is easily applied by using a rosin core wire solder, such as is sold at most electrical supply stores.

The iron may be heated in any convenient manner, by gas, gasoline torch, the alcohol

lamp, or over charcoal. It should be heated until a comfortable sensation of warmth is felt when the iron is held about six inches from the face. Do not have it too hot, as it is then difficult to keep the solder in place.

Tin the iron before using, for a quarter of an inch on one side of the point only. If the iron does not tin readily, polish the part to be tinned with an old file while the iron is hot and apply the solder immediately.

The handling of cotton insulated wire is made easier if the ends are waxed with paraffine or shellacked; this prevents fraying of the insulation.

All joints in wire should be soldered. Enameled wire must have the enamel removed before soldering. In doing this be careful not to nick the wire, as it will surely cause a break later. Two types of splice are used for wire, the pigtail and the Western Union. The first is shown at A, Fig. 2, the second at B. In soldering the pigtail

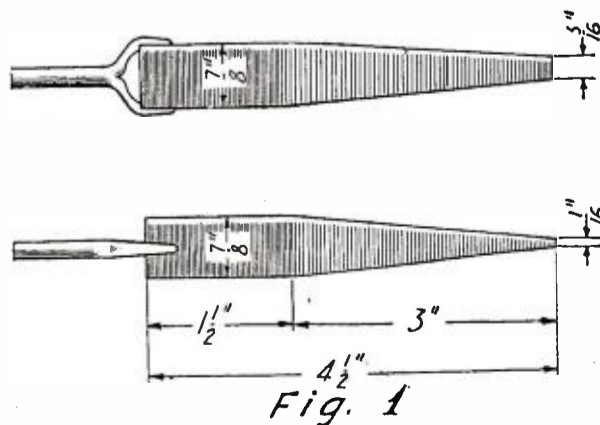

In Order to Do Good Soldering It Is Essential to Have the Proper Kind of Iron. This Is the Best Kind to Use.

(Continued on page 336)



THIS Department is conducted for the benefit of our Radio Experimenter. We shall be glad to answer here questions for the benefit of all, but we can only publish such matter of sufficient interest to all.

1. This Department cannot answer more than three questions for each correspondent.
2. Only one side of the sheet should be written upon; all matter should be typewritten or else written in ink. No attention paid to penciled matter.
3. Sketches, diagrams, etc., must be on separate sheets. This Department does not answer questions by mail free of charge.
4. Our Editors will be glad to answer any letter, at the rate of 25c for each question. If, however, questions entail considerable research work, intricate calculations, patent research, etc., a special charge will be made. Before we answer such questions, correspondents will be informed as to the price charge.

You will do the Editor a personal favor if you will make your letter as brief as possible.

A SIMPLE CIRCUIT WITH HIGH AMPLIFICATION

(421) Mr. Ralph S. Hall, McLeansboro, Illinois, requests:

Q. 1. Please give me the hookup for a single circuit tuner consisting of variocoupler, and using one stage of radio frequency and two stages of choke coil audio frequency amplification.

A. 1. The hookup requested by you is shown on this page. In this circuit, the output of the first tube is coupled to the second tube through a condenser. The plate circuit of the first tube is tuned to the frequency of the incoming oscillations and the plate circuit of the detector tube is loosely coupled to the primary of the variocoupler by means of the rotor of the variocoupler which acts as a tickler coil to provide regeneration. Two stages of audio frequency amplification, using choke coils for this purpose, are also shown. This is a very efficient circuit and good results can be obtained with it.

Q. 2. Explain the simple construction of a radio frequency transformer or coil to use for short waves in above hookup.

A. 2. In the diagram, a coil shunted by a condenser is shown to tune the plate circuit of the radio frequency amplifying tube. For short waves, this coil and condenser may be substituted by a variometer. If the arrangement shown is used, the coil should be wound on a tube, 3" in diameter, with about 35 turns of No. 22 D.C.C. wire, and shunted by a .0005 M. F. condenser to cover the wave length range of from 200 to 550 meters.

Q. 3. In case I purchased a radio frequency transformer, what kind would you recommend? I am using one A. P. amplifier tube and three Meyers tubes in my set.

A. 3. Amplifying tubes in this circuit should be either A. P. amplifiers or RAC-3 Audions. The detector tube may be any type of soft detector tube. Radio frequency transformers are not required in this circuit.

LONG AND SHORT WAVE TUNER

(422) Mr. William Fellman, Philadelphia, Pa., requests:

Q. 1. Please publish circuit showing method of transferring from long to short wave reception, using detector and two step amplifier to detect and amplify either. Long wave reception is to be effected on honeycomb coils and short wave reception on variocoupler and two variometers.

A. 1. Diagram requested by you is shown on these pages. A single anti-capacity switch changes from the short wave tuner to the long wave tuner. A separate switch is used to change the aerial from the primary coil of one tuner to the primary coil of the other. The condenser across the secondary honeycomb coil should be shown as a variable condenser.

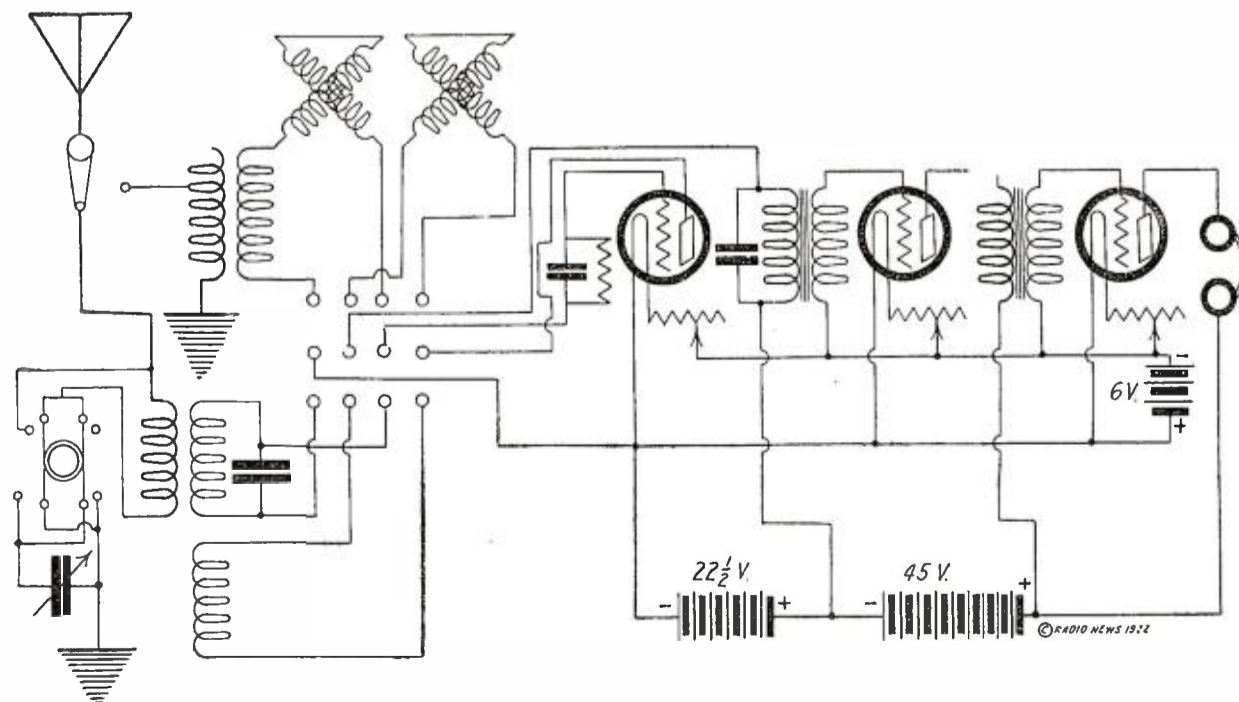

Q. 422.—By Means of a 4 Pole D. T. Switch and One S. P. D. T. Switch Transfer from Honeycomb Coil to Short Wave Regenerative Receivers May Be Quickly Made with This Circuit. Only One Detector and Amplifier Unit Is Required.

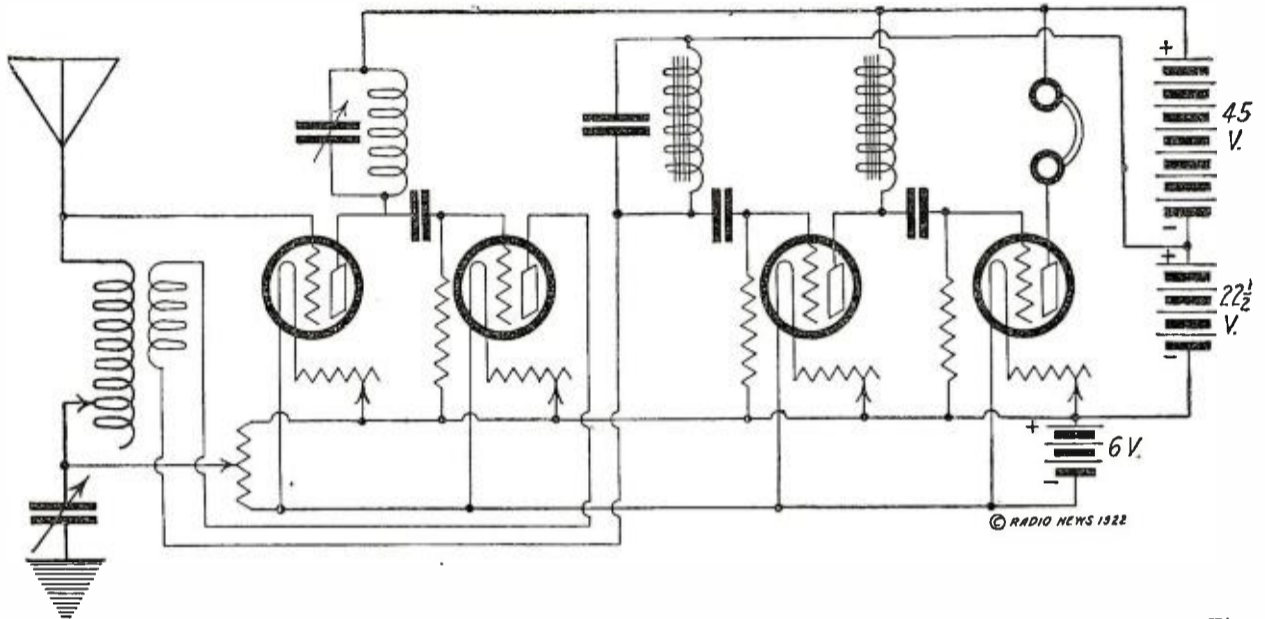

Q. 421.—High Amplification Is Obtained with This Circuit Using Only Four Tubes. The First Tube Amplifies at Radio Frequency and Double Regeneration Is Obtained. For Short Waves the Plate Circuit of the First Tube May Be Tuned with a Variometer.

THREE STAGE RADIO FREQUENCY AMPLIFIER

(423) Mr. Ross Watson, Cleveland, Ohio, requests:

Q. 1. I wish to use a three step amplifier and connect it to my Westinghouse RC Receiver with two step audio amplifier. Please advise if this is possible and furnish wiring diagram.

A. 1. Diagram requested by you is shown on these pages. In this diagram, a single plate battery is indicated which supplies the plate current to all of the tubes. While this is possible in some cases, much better results can usually be obtained by using a separate plate battery to supply the plate current to the first three tubes, amplifying at radio frequency. A separate plate battery for the detector tube can also be used to advantage. It will be seen from this diagram that the radio frequency amplifier occupies the position between the tuner and the detector. The tickler coil of the tuner is shown connected in the plate circuit of the first amplifying tube. It may be possible to connect this tickler coil in the plate circuits of either of the two succeeding tubes or even in the detector tube plate circuit; otherwise it may be short-circuited entirely. A circuit of this type employing extreme amplification is best suited for reception with a loop. If an aerial is used, strong signals in the vicinity of the receiving station may paralyze the tubes.

ADDING RADIO FREQUENCY AMPLIFICATION REGENERATIVE TUNER

(424) Mr. James Wilson, New York, wants to know:

Q. 1. Please show method of adding two stages of radio frequency amplification to short wave regenerative receiver.

A. 1. One method of accomplishing this is shown in the diagram published on these pages. In this circuit, the primary and secondary of the receiver function as a radio frequency transformer. As it is possible to tune both of these circuits, very high amplification and great selectivity can be obtained. A radio frequency transformer of suitable wave-length range is used between the first and second tubes. To reduce the number of controls, these transformers may be of the iron-core type, which do not require to be tuned. A tuning coil and condenser are connected in series with the antenna circuit and the potentiometer across the A battery is 200 to 400 ohms resistance. This circuit may be used in connection with a loop by disconnecting the antenna and ground and omitting the first tuning coil. One side of the loop should be connected directly to the grid of the first tube and the other side to the center of the potentiometer. A variable condenser should be shunted across the loop.

RADIO FREQUENCY AMPLIFICATION AND CRYSTAL DETECTOR

(425) Mr. John Rockwell, Washington, asks:

Q. 1. Please give hookup of an amplifier tube and transformer with a crystal set.

A. 1. We show hookup on these pages which will give good results with a crystal detector. In this circuit, regeneration is obtained with a tickler coil and the output is coupled to the detector by means of a radio frequency transformer. By this method, good amplification of the incoming oscillations is obtained before they are rectified by the crystal. If a good piece of crystal is used, the results will be very satisfactory, as a crystal provides much better rectification than is obtainable with a vacuum tube.

Q. 2. I wish to make a transformer using 110 volts and 60 cycles current. What would be the size of wire and turns on primary and secondary to obtain 45 volts. I wish to use it for the amplifier tubes.

A. 2. Alternating current cannot be used to supply the plate current of a vacuum tube for reception. It is possible to rectify the alternating current, but this is not desirable, as the hum of the A.C. is difficult to avoid.

10 WATT RADIOPHONE HOOKUP

(426) Mr. Francis Cherry, Wolfe City, Texas, wants to know:

Q. 1. Please give hookup for a radio telephone using two 5 watt tubes and 100 watt transformer to supply both the filament and plate currents with electrolytic rectifier.

A. 1. The diagram requested by you is shown on these pages.

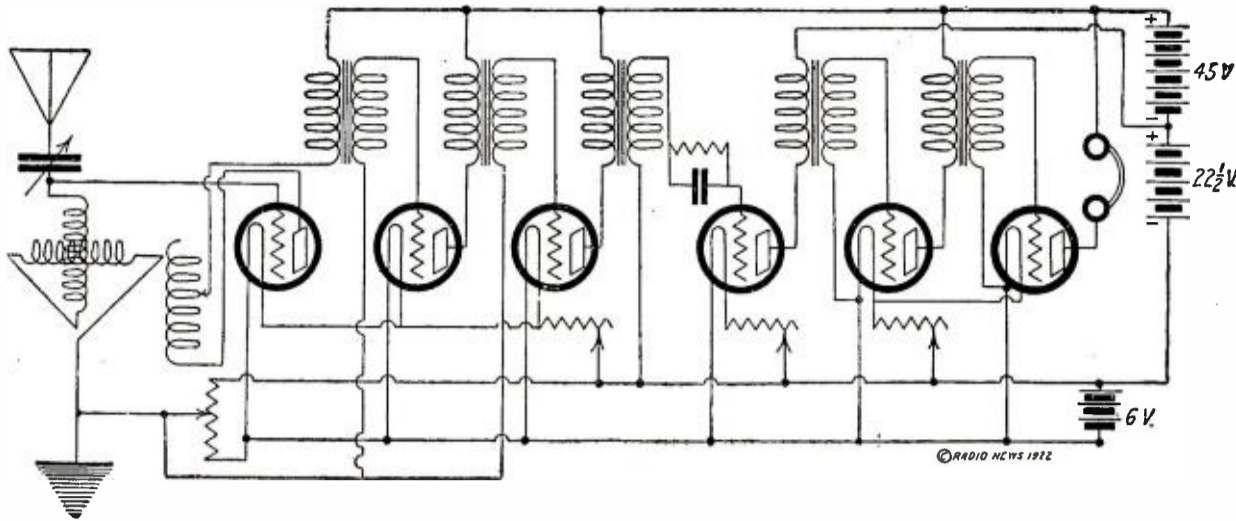

Q. 423.—This Diagram Shows the Method of Adding Three Stages of Radio Frequency Amplification to a Single Circuit Regenerative Receiver Before the Detector and Two Stage Amplifier. A Common Plate Battery Is Shown But It Would Be Better to Use a Separate Plate Battery for the First Three Tubes.

- Q. 2. Could primaries of Ford spark coils be used as the above choke coils?
 A. 2. No. These choke coils should have a value of 1½ henries each.
 Q. 3. Please give circuit of two steps of radio and two steps of audio frequency amplification with filament control jacks.
 A. 3. This circuit may be found in this department in the July issue of RADIO NEWS.

MAGNAVOX STEP-DOWN TRANSFORMER DATA

(427) Mr. A. H. Ellis, Rochester, Minnesota, requests:
 Q. 1. Will you please publish directions for winding the step-down transformer used in the Magnavox?
 A. 1. This transformer is wound on an iron core consisting of iron wires. The diameter of the core is 5/8". This is covered with insulation. The primary of the transformer is wound with 12,700 turns of No. 35 enamelled wire in 10 pies, each pie 1/4" thick. Each pie requires 486 feet of wire; total resistance of the primary is 1,500 ohms; secondary is wound with 621 turns of No. 22 enamelled wire in 9 pies, each pie 5/32" thick; each pie of the secondary takes 23½ feet of wire; total resistance of the secondary is 3.5 ohm. Inside diameter of all the pies is 25/32".

THE LENGTH OF AN AERIAL

(428) Mr. Stanley Putnam, Tonasket, Washington, asks:
 Q. 1. Would an aerial 50' long be as efficient as one 300' long?
 A. 1. Both aeriels would be quite efficient, but

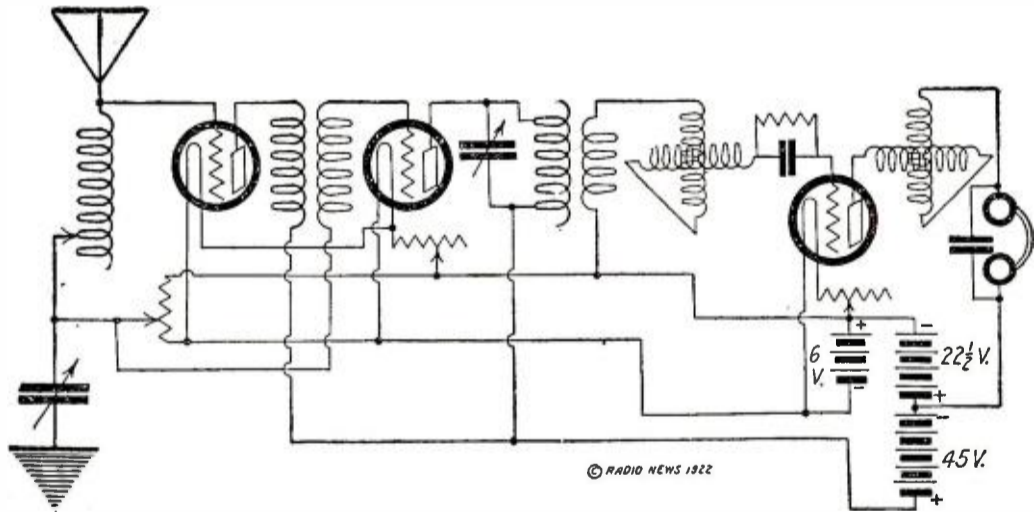

Q. 424.—An Exceptionally Convenient and Efficient Method of Adding Radio Frequency Amplification to a Standard Loose-Coupled Short Wave Receiver. Tuned Radio Frequency Amplification Is Obtained With This Circuit Which Is Very Selective.

for the reception of short waves a longer aerial would not be as efficient as the short one. To receive efficiently the short waves, the natural wave length of the aerial should be less, and not more than, the wave length it is desired to receive. With an aerial of slightly shorter natural period than the wave length of the incoming oscillations, a small loading coil may be used as the primary of the receiving transformer. The primary and secondary of the tuner form a step-up transformer which increases the voltage applied on the grid of the detector. If the aerial has a longer natural wave length than the one to be received, it is necessary to use a condenser in series with the aerial, but by this method it is only possible to reduce the natural wave length of the aerial a certain degree without considerable loss of efficiency.

AUDIO FREQUENCY TRANSFORMERS

(429) Mr. J. R. Schumm, Connecticut, wants to know:
 Q. 1. Could you give me winding specifications or advise me how I can build an amplifying transformer for the addition of two amplifying stages?
 A. 1. Full information on the method of winding and constructing an audio frequency transformer is published on page 57 of the July issue of RADIO NEWS.

TUNED RADIO FREQUENCY CIRCUIT

(430) Mr. Oliver Malmanger, Huxley, Iowa, wants to know:

- Q. 1. In the one stage radio frequency amplifier circuit. Question 344 April-May issue of RADIO NEWS, does the plate variometer act as auto-transformer? Would another variometer be required in the plate circuit of the detector to make it regenerate?
 A. 1. In this circuit, the first tube is coupled to the detector tube through a condenser. A variometer is used to tune the plate circuit of the amplifying tube to provide regeneration. Control of regeneration and oscillation may be obtained with this variometer. Another variometer may be inserted in the plate circuit of the detector tube if desired.
 Q. 2. In the short wave regenerative circuit using two variometers, is it better to connect lower wire of the secondary to the filament of tube or the plate variometer.
 A. 2. This connection should be made to the positive of the filament of the tube, and a condenser should be shunted across the telephones and plate battery. This connection provides much better stability of operation than the other method mentioned by you.

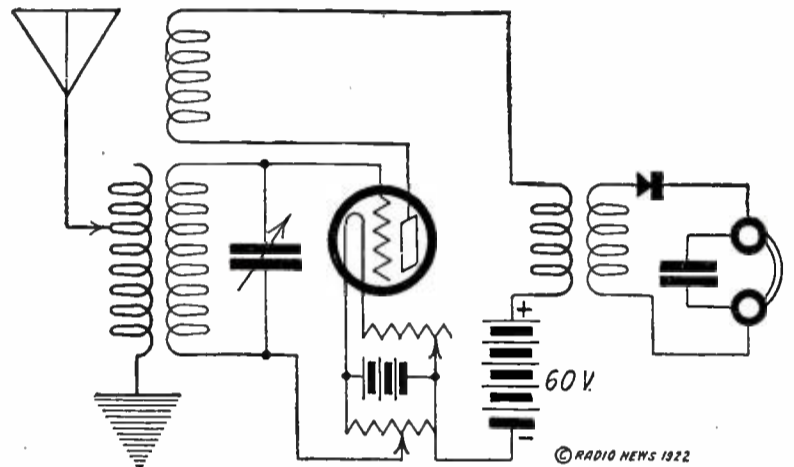

Q. 425.—The High Frequency Oscillations Are Greatly Amplified by the Vacuum Tube Before They Are Rectified by the Crystal. This Is the Best Method to Increase the Sensitivity of a Crystal Receiver. A Good Crystal Gives Better Rectification Than V. T.

A. 3. A grounded metal shield lining the back of the front panel, is of considerable advantage in eliminating the body capacity effect.

QUEST OF A SELECTIVE CIRCUIT

(433) Mr. F. Williams, Rosecliff, Cleveland, Ohio, wants to know:
 Q. 1. Is there any circuit using a variocoupler which can tune to 360 meters and eliminate all the stuff below 275 meters?
 A. 1. The diagrams given in answer to questions 321 and 324 are quite selective, particularly if used in connection with a loop.
 Q. 2. Will a 200' single wire aerial help to attain the above result?
 A. 2. The length of the aerial does not affect the selectivity, unless a special type of aerial, such as the Beverage antenna, is used.

RADIO OR AUDIO FREQUENCY AMPLIFICATION

(434) Mr. David Pickerel, Jackson, Ohio, requests:
 Q. 1. Which is better and more practicable for use with a short wave regenerative receiver; radio or audio frequency amplifiers?
 A. 1. Both are practicable and each is the best in its own sphere. Radio and audio frequency amplification are separate, and comparisons cannot be made as to which is the better. One cannot do the work of the other. Radio frequency amplification greatly increases the sensitivity of the re-

RANGE OF A LOOP

(431) Mr. Arthur Jones, Zanesville, Ohio, wants to know:
 Q. 1. Can I hear KDKA on a loop aerial with

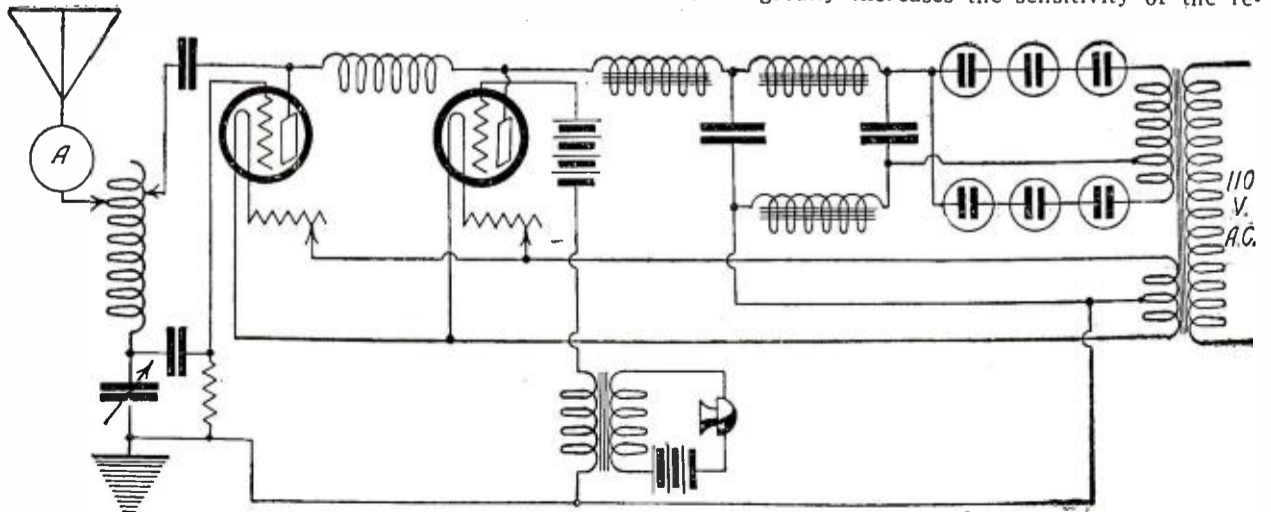

Q. 426.—The Circuit of a 10 Watt Radiophone Transmitter Employing the Constant Current System of Modulation. The High Tension Is Supplied by the A. C. Line Through a Transformer. The A. C. Is Rectified by an Electrolytic Rectifier.

14 YEARS OF KNOWING HOW

IF experience means anything to you, the fact that Murdock Receivers have been delivering satisfaction on a "money-back" basis for 14 years will influence your choice. Those years of experience have finally resulted in the No. 56 Murdock Headset which combines rugged strength with clear, distinct reproduction of voice and music. Each ear piece is "Murdock Moulded" into one durable unit, capable of protecting the delicate adjustments through years of rough use. The improved signal corps type headband adds the feature of comfort.

Go to your dealer and examine Murdock Phones before you buy. Compare their durable construction. Test their sensitiveness. Convince yourself that there are no other phones so good at so low a price. And then, *after you have* bought, the 14-day trial offer assures you of satisfaction with your purchase.

PRICES—2000 OHM \$5.00—3000 OHM \$6.00

MURDOCK PHONES

WM. J. MURDOCK, 344 Carter St., Chelsea, Mass.

21 Jewel Burlington

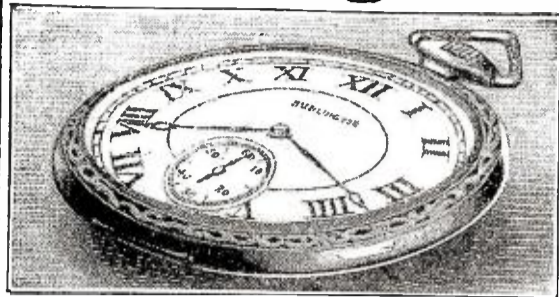

Adjusted to the Second 21 Ruby and Sapphire Jewels
Adjusted to Temperature 25 Year Gold Strata Case
Adjusted to Isochronism Your Choice of Dials
Adjusted to Positions (Including Montgomery R. R. Dial)
New Ideas in Thin Cases

Only \$1⁰⁰ Down

Only One Dollar Down will buy this masterpiece of watch manufacture. The balance you are allowed to pay in small, easy, monthly payments. A 21-Jewel Watch—is sold to you at a price much lower than that of other high-grade watches. Besides, you have the selection of the finest thin model designs and latest styles in watch cases. Write for FREE Watch Book and our SPECIAL OFFER today.

Write *While This Special Offer Lasts*

Get the Burlington Watch Book—write today. Find out about this great special offer which is being made for only a limited time. You will know a great deal more about watch buying when you read this book. You will be able to "steer clear" of the over-priced watches which are no better. Write for watch book and our special offer TODAY!

Burlington Watch Company
Dept. C594, 19th St., and Marshall Blvd., Chicago

TRY "WECO"



"You Will Like Trading With Us"

IMMEDIATE DELIVERY ON THE FOLLOWING MATERIAL

Complete line of SIGNAL Tuning and Loading Coils

Radiotron UV-200, detectors.....	\$5.00
Radiotron UV-201, amplifiers.....	6.50
Radiotron UV-202, 5 watt power.....	8.00
Aeriotron Tubes, all types	
Westinghouse Aerola "Seniors".....	65.00
Westinghouse RC Sets.....	132.50
Clapp-Eastham HR and HZ Sets, each.....	40.00
Connecticut J-110, 3,000-ohm Telephones.....	7.00
Federal No. 53-W, 2,200-ohm Telephones.....	8.00
Western Electric, Type 1001-A.....	12.00
King Amp-li-tones, a loud speaker, using your own telephones.....	12.00
Electrose 4" Dial, very handsome.....	1.50
WECO Sockets, all moulded, very efficient.....	.75
WECO 270° Rheostat Dial No. 308.....	.90
WECO 3" Dial, No. 307, handsome.....	1.00
WECO 4" Dial, No. 306, handsome, heavy.....	1.45
Brach Lightning Arresters, inside type.....	2.50
Brach Lightning Arresters, outside type.....	3.00
Paragon Amplifying Transformers.....	5.00

Distributers for Radio Corporation, Clapp-Eastham, Federal, Electrose, Signal, General Radio, Acme, Remler, Ace, Ever-ready, Klossner, Murdock, Frost, Baldwin, Chelsea and others.

WHITALL ELECTRIC COMPANY
WESTERLY, RHODE ISLAND

Dealers write for catalogs and discounts

CUT PRICES

Radio Service V. T. Sockets.....	\$0.80
No. 14 Solid Copper Aerial Wire, pound.....	.40
Seven-strand Copper Aerial Wire, 100 feet.....	.85
Cyclone Small "B" Batteries, 22½-volt.....	.90
.002 M. F. Phone Condensers.....	.25
.0005 M. F. Grid Condensers.....	.25
Titan Storage Batteries, 6-volt.....	14.00

KENSINGTON RADIO SUPPLY CO.
4416 18th Ave. Brooklyn, N. Y.

Single Layers Inductances

(Continued from page 261)

TABLE I—VALUES FOR K

$\frac{2a}{b}$	K	$\frac{2a}{b}$	K	$\frac{2a}{b}$	K	$\frac{2a}{b}$	K	$\frac{2a}{b}$	K
0.00	1.0000	1.20	0.6475	2.80	0.4452	5.40	0.3050	17.0	0.1394
0.05	.9791	1.25	.6381	2.90	.4370	5.60	.2981	18.0	.1336
0.10	.9588	1.30	.6290	3.00	.4292	5.80	.2916	19.0	.1284
0.15	.9391	1.35	.6201	3.10	.4217	6.00	.2854	20.0	.1236
0.20	.9201	1.40	.6115	3.20	.4145	6.20	.2795	22.0	.1151
0.25	0.9016	1.45	.6031	3.30	.4075	6.40	.2739	24.0	.1078
0.30	.8838	1.50	0.5950	3.40	.4008	6.60	.2685	26.0	.1015
0.35	.8665	1.55	.5871	3.50	0.3944	6.80	.2633	28.0	.0959
0.40	.8499	1.60	.5795	3.60	.3882	7.00	0.2584	30.0	.0910
0.45	.8337	1.65	.5721	3.70	.3822	7.20	.2537	35.0	0.0808
0.50	0.8181	1.70	.5649	3.80	.3764	7.40	.2491	40.0	.0728
0.55	.8031	1.75	0.5579	3.90	.3708	7.60	.2448	45.0	.0664
0.60	.7885	1.80	.5511	4.00	.3654	7.80	.2406	50.0	.0611
0.65	.7745	1.85	.5444	4.10	.3602	8.00	.2366	60.0	.0528
0.70	.7609	1.90	.5379	4.20	.3551	8.50	.2272	70.0	.0467
0.75	0.7478	1.95	.5316	4.30	.3502	9.00	.2185	80.0	.0419
0.80	.7351	2.00	0.5255	4.40	.3455	9.50	.2106	90.0	.0381
0.85	.7228	2.10	.5137	4.50	0.3409	10.0	0.2033	100.0	.0350
0.90	.7110	2.20	.5025	4.60	.3364	11.0	.1903		
0.95	.6995	2.30	.4918	4.70	.3321	12.0	.1790		
1.00	0.6884	2.40	.4816	4.80	.3279	13.0	.1692		
1.05	.6777	2.50	0.4719	4.90	.3238	14.0	.1605		
1.10	.6673	2.60	.4626	5.00	.3198	15.0	.1527		
1.15	.6573	2.70	.4537	5.20	.3122	16.0	.1457		

TABLE II—VALUES FOR K₁

$\frac{d}{D}$	K ₁	$\frac{d}{D}$	K ₁	$\frac{d}{D}$	K ₁	$\frac{d}{D}$	K ₁	$\frac{d}{D}$	K ₁
1.00	0.557	0.55	-0.041	0.34	-0.522	0.18	-1.158	0.09	-1.851
0.95	.506	.50	.136	.32	.583	.17	1.215	.08	1.969
.90	.452	.48	.177	.30	.647	.16	1.276	.07	-2.102
.85	.394	.46	.220	.28	.716	.15	1.340	.06	2.256
.80	.334	.44	.264	.26	.790	.14	1.409	.05	2.439
.75	.269	.42	.311	.24	.870	.13	1.483	.04	2.662
.70	.200	.40	.359	.22	.957	.12	1.563	.03	2.950
.65	.126	.38	.411	.20	-1.053	.11	1.650	.02	-3.355
.60	.046	.36	.465	.19	1.104	.10	1.746	.01	-4.048

N.B.—Values of K₁ become negative after K₂ = 0.046 is reached

TABLE III—VALUES FOR K₂

n	K ₂	n	K ₂	n	K ₂	n	K ₂	n	K ₂
1	0.000	7	0.244	25	0.304	60	0.322	200	0.333
2	.114	8	.253	30	.308	70	.324	300	.334
3	.166	9	.260	35	.312	80	.326	400	.335
4	.197	10	.266	40	.315	90	.327	500	.336
5	.218	15	.286	45	.317	100	.328	700	.336
6	.233	20	.297	50	.319	150	.331	1000	.336

Our coil then must have the following dimensions:

diameter=7.62 cms.=3 inches
length=14 cms.=5.5 inches ⑭
number of turns=229 ⑯
size of wire=No. 24 D. S. C.

If we leave our coil as it is and consider our capacity to be continuously variable from 0.0001 mfd. to 0.001 mfd., we can cover a range of wave-lengths from 790 to 2500 meters (obtained from ③).

It will be seen then that with this combination of inductance and capacity, the minimum wave-length is 790 meters. This, however, is not low enough for the reception of either commercial stations on 600 meters, or amateur stations on 200 meters.

Our capacity being fixed within a definite range, the next logical step is to vary the value of inductance in the circuit, to enable us to receive on the shorter waves.

This brings us to the subject of tapping coils. Taps may be brought out from coils in a number of ways. The most common method is that of including a certain equal number of turns between each tap, or what amounts to the same thing, measure off equal lengths on the winding, and tapping. This method, while it is the easiest and most convenient, is not the best, because it does not allow the selection of the maximum value of inductance with the minimum capacity for any given wave-length. This is essentially necessary for the most efficient working of magnetically coupled circuits and particularly so for vacuum tube circuits, where for best results inductance should predominate over capacity.

To begin with, we will choose as the mini-

imum wave-length to which we desire to tune, when using a minimum capacity of 0.0001 mfd., that of 145 meters. From formula ④ it is found that an inductance of 60 microhenries is necessary. This then will be the inductance of our first tap. Any desired number of taps may be brought out from the coil, but for an example we will take five. The whole coil then will be divided into five sections, the respective inductance values of which we will now determine.

To ascertain this value of inductance for each tap, we must calculate a constant to be used as a multiplier. This constant depends upon the inductance of the whole coil, the inductance of the first tap, and the total number of taps for its value, or

$$K_m = \sqrt{L_t^{t-1} / L_1} \tag{22}$$

where, K_m=constant to be determined.

t=number of sections, or taps.
L_t=total inductance of the coil.
L₁=inductance of the first tap.

Then substituting, we have
t=5
L_t=1760
L₁=60
hence

$$K_m = \sqrt[4]{1760 / 60} \tag{23}$$

solving, K_m=2.32723
to find the inductance of any tap.

$$L = K_m^{t-1} L_1 \tag{25}$$

where

CHEMISTS PREDICT STARTLING NEW ERA
Sun's Rays, Earth's Rotation and Atomic Energy in Matter to Be Used.
SEE REVISING OF BIBLE
Light Like Firefly's May Be Produced by Chemistry, American Society Hears.

DEMAND FOR INDUSTRIAL CHEMISTS INCREASING.
"It is probably not far wide the mark to assert that there more than 25,000 chemists employed in the United States day and the advantage which laws their employment has made so obvious that the demand is constantly increasing." Dr. Charles E. Menroe, of the National Research Council and emeritus of the George Washington University at the opening of the evening preparatory school of the Y. M. C. A. recently said.

SAUSAGE GETS ATTENTION OF CHEMISTS
Is One of Many Topics in Picture's Drawings

CHEMISTRY EXPERT HEADS 'CLEAN CLOTHES' COLLEGE
In Eleven Weeks He Teaches How to Remove All Traces of Hardship From Linen and Makes Student a Real Laundryman.

CHEMISTS CHANGE ALCOHOL INTO HIGH QUALITY SILK
Government Experiments Set Pace for New Industry Already Under Way and Patient Silkworm May Lose Popularity

CHEMISTRY IN THE HOME
100 of our great-grandmother's recipes were handed down to her daughter or passed back to her in an inquisitive No one thought of calling in aid to the work of the kitchen at to-day's chemists have entered on a new era. In a fairer life, both home and industry, the good chemist gives the make-work lighter and give the more materials with which to

AMERICA'S FUTURE BEFORE CHEMISTS
Dr. E. F. Smith Urges Upon Associates Recognition of Nation's Claims.

CHEMICAL SCIENCE MAY CUT SHOE PRICES
New Methods in Tanning to Be Discussed by Experts at Meeting of American Society.
4,000 EXPERTS TO ATTEND
Sessions Will Be Held at Columbia University Next Month—Scientists to Speak.
Shoe prices may trend downward as a result of new processes of tanning based on studies of electrical discharges and other unusual factors, which will be discussed by the leather chemistry section of the American Chemical Society, which will meet at Columbia University Sept. 10-12.

CHEMISTS IN MONTREAL LEARN OF NEW GLASS
Said to Admit Unlimited Light and Bar All Heat.

Chemists Are Badly Needed To-day In Every Branch of Industry

All industry today is three-fourths chemical. Every day brings new announcements of new ways in which chemistry is employed in business and industry. The sudden and almost unbelievable expansion of the chemical field in the United States has increased the need for trained men in our country. Industrial plants of all kinds pay tempting salaries to get good men—salaries of \$10,000 to \$12,000 a year are not unusual for those who have proven their abilities. If you want a profession that offers unlimited possibilities—if you are looking for more money—if you like fascinating work—take up chemistry. No other vocation offers such splendid opportunities for real money and rapid advancement. Chemistry is now recognized as the coming great science and the demand for trained men is increasing every month.

Learn Chemistry at Home

We will teach you Chemistry right in your own home, and in your spare time, in a practical and intensely interesting way. Our home study course written by Dr. T. O'Connor Sloane is practical, logical and remarkably simple. Endorsed by leading scientific and educational authorities. The entire course is illustrated by so many experiments that are performed right from the start that anyone, no matter how little education he may have, can learn and thoroughly master every lesson. Dr. Sloane teaches you in your own home with the same individual and painstaking care with which he has already taught thousands in the class room. And Dr. Sloane personally examines and corrects all examination papers, pointing out your mistakes and correcting them for you. His personal training will be of inestimable value to you in your future career. If you really want to learn Chemistry and will honestly apply yourself to our lessons, our course will give you just as thorough and just as complete an education in general chemistry as you would have received had you been able to attend College.

Dr. T. O'Connor Sloane Will Teach You



Easy Monthly Payments

You can pay in small monthly amounts as you go along. The price of our course is very low and includes everything, even the chemistry outfit—there are no extras to buy with our course. Our plan places a chemical education within the reach of everyone. No matter what your income is, you can meet our low terms, and you do not have to give up your present employment while learning.

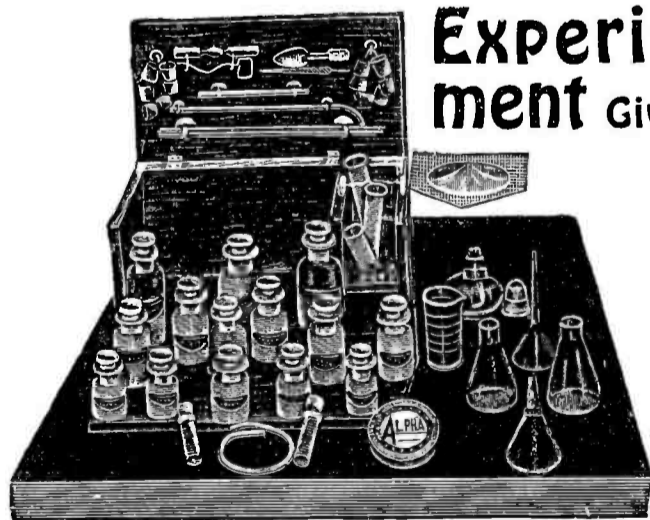

Experimental Equipment Given Free To Every Student

We give to every student, absolutely free of charge, this chemical equipment including everything you need for the entire course with the exception of a few pieces of apparatus which we teach you how to make. You couldn't buy so complete an outfit anywhere for one cent less than \$20.00. There are forty-two pieces of laboratory apparatus and supplies and eighteen different chemicals and reagents all enclosed in a fitted heavy wooden box with hinged front and cover. This hand-finished box serves not only as a case for the outfit but as a laboratory accessory for performing countless experiments.

Special 30 Day Offer

Besides furnishing the student with his Experimental Equipment as described above, we are making an additional special offer for a short while only. You owe it to yourself to find out about it. Write today for full information and free book "Opportunities for Chemists." Send the coupon right now while it is fresh in your mind. Or just write your name and address on a postal and mail it to us. But whatever you do, act today before this offer is withdrawn.

Chemical Institute of New York, Inc.

Home Extension Division 8

140-R LIBERTY STREET, NEW YORK CITY

Dr. Sloane, Educational Director of the Chemical Institute of New York, is one of this country's foremost authorities on chemistry. He was formerly Treasurer of the American Chemical Society and is a practical chemist with many well-known achievements to his credit. Not only has Dr. Sloane taught chemistry for years, but he was for a long while engaged in commercial chemistry work.

Many people would pay big money to have Dr. Sloane teach them chemistry. You can secure his services and personal training without one cent of extra expense by enrolling with the Chemical Institute of New York.

CHEMICAL INSTITUTE OF NEW YORK, Home Extension Division, 8, 140 R Liberty St., New York City.

Please send me at once without any obligation on my part, your free Book "Opportunities for Chemists," and full particulars about the Experimental Equipment given free to every student. Also please tell me about your plan of payment and your special 30 day offer.

NAME

ADDRESS

CITY

STATE
R. N. Aug., '22.

**A NEW BOOK FOR EXPERIMENTERS!
ELEMENTARY TEXT-BOOK
ON WIRELESS VACUUM TUBES**

by
JOHN SCOTT-TAGGART
Member of the American Institute of Electrical Engineers
WRITTEN EXPRESSLY FOR THE AMERICAN AMATEUR

230 Pages. 130 real practical circuits.
The best book on C.W. and Telephony.
Handsomely bound in blue art vellum.

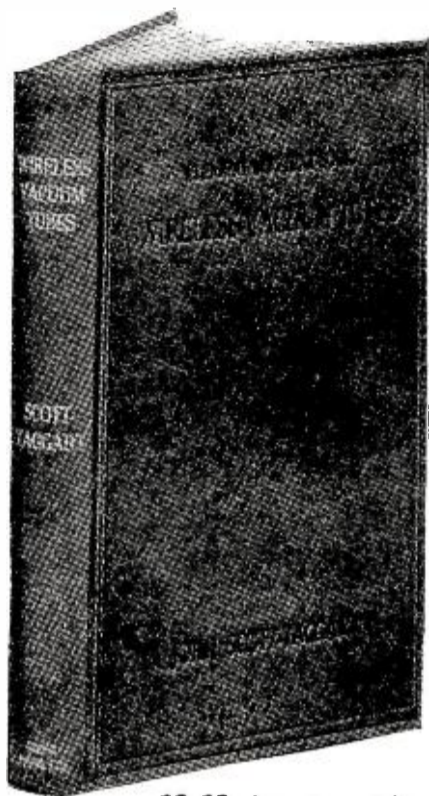

\$3.00 (post paid)

Retailers are invited to send orders for 12 or more copies on special terms. Amateurs should ask their dealers or order direct from

RADIO PRESS, Ltd.
34, Norfolk Street, London, W.C.2., England
N. Y. Agents, JOHN FIRTH & CO., 709 Sixth Ave.

For Immediate Delivery

**THE RADIO SHOP
VITALI-PHONE**

List Price
\$45.00

F. O. B. Newark, N. J.



The only
floating Coil
Loud Speaker
on the market
that is free of
distortion

**"CLEAR
AS A
BELL"**

DEALERS—No waiting. Immediate deliveries. Write for discounts.

THE RADIO SHOP of NEWARK
Dept. V, 41 S. Orange Ave., Newark, N. J.

AUGUST SPECIALS

One pair Everett 3000 ohm phones and a Whittal audion socket for **\$8.50**
One pair Western Electric 2200 ohm phones and a Firco plug round type. **\$16.00**

We pay transportation anywhere in U. S. Send stamp for price list.

ASHTABULA RADIO SALES CO., Ashtabula, O.

L=inductance of that portion of the coil up to and including the tap. K, t and L1 have the same values as in (22).

Substituting in (25) and solving, we find the inductance values of our tapped sections are as follows:

- 1st tap=L₁=60 microhenries.
- 2d tap=K_mL₁=139 microhenries.
- 3d tap=K_m²L₁=324 microhenries.
- 4th tap=K_m³L₁=756 microhenries.
- 5th tap or total coil=K_m⁴L₁=1760 microhenries.

By using formula (11), which was used in first determining the number of turns on the whole coil, the proper turns from which to bring out the taps may be found. This operation, although somewhat tedious, is not difficult, for it consists only of substituting known values and solving. Below are listed the wave-length ranges of these taps when used with a capacity of 0.0001 mfd. and 0.0003 mfd.

L	Tap	C=0.0001	
		λ	λ
60 μh	1	145 meters	253 meters
140 μh	2	223 meters	386 meters
325 μh	3	339 meters	588 meters
756 μh	4	518 meters	897 meters
1760 μh	5	790 meters	1397 meters

From this it will be noticed that a sufficient overlap of wave-lengths is obtainable from one tap to the next, using very small capacity adjustments. When all of the coil is used and the maximum capacity of 0.001 mfd., the maximum wave-length is, of course, 2500 meters.

Heretofore we have considered the determination of the size of winding and number of turns required to produce a given amount of inductance. Let us consider for a moment the case of determining the inductance of a coil of given size and number of turns. This may be done by using formula (8), previously explained, namely:

$$L=4\pi^2 \frac{a^2 n^2}{b} K \times 10^{-3}$$

This formula gives quite accurate results for the most cases, but it must be remembered that this is the true inductance of the current sheet only. This is a theoretical winding of a conducting tape of infinite thinness whose adjacent turns touch, but are not in electrical contact. Since, however, the material of which we wind our coil has a finite thickness and the turns are separated from each other by a finite distance, it is necessary, if we wish to arrive at a more accurate value

of inductance, to apply a correction. For round wire this correction factor becomes,

$$L=L_c - 4\pi a n (K_1 + K_2) \times 10^{-3} \quad (26)$$

where
L=inductance of coil
L_c=inductance of current sheet
a=radius of coil in centimeters
n=number of turns
K₁=constant depending on the ratio of d/D

(Table II)
where, D=pitch of winding
d=diameter of bare wire
K₂=constant depending for its value on n (Table III)

In most coils the correction is practically negligible.

At the conclusion of this article will be found tables for the values of K, K₁, K₂, and curves for f and log₁₀ f, for which the writer is indebted to the Bureau of Standards publication on Radio Instruments and Measurements. There is also a table giving the number of turns per inch of wire of various kinds of insulation.

The computations necessary in this work, as has been before stated, though somewhat tedious, are not difficult and, if use is made of logarithms, the work becomes greatly simplified.

It is probably best here to caution against using dimensions in any of the formulae in any other unit than the centimeter. One inch =2.54 cm.

Table IV—Turns per inch of wire

Size of wire	D. C. C.		S. C. C.		En- amel	En- amel and S. C. C.	En- amel and S. C. C.
	D. C. C.	S. C. C.	D. C. C.	S. C. C.			
18	20.3	22.3	22.6	23.6	24.0	22.9	21.7
19	22.5	25.1	25.4	26.8	27.2	25.8	24.2
20	24.4	27.4	27.8	29.5	30.1	28.4	26.5
21	27.4	30.8	30.8	32.8	33.6	31.5	29.6
22	30.0	34.1	34.1	36.6	37.7	35.0	32.7
23	32.7	37.6	37.6	40.7	42.3	39.0	36.1
24	35.6	41.5	41.5	45.3	47.2	43.1	39.7
25	38.6	45.7	45.7	50.3	52.9	47.9	43.7
26	41.8	50.2	50.2	55.7	59.0	52.8	47.8
27	45.1	55.0	55.0	61.7	65.8	58.1	52.1
28	48.5	60.1	60.1	68.3	73.9	64.4	57.0
29	51.9	65.5	65.5	75.4	82.2	70.6	61.9
30	55.5	71.3	71.3	83.1	92.3	77.9	67.4
31	59.1	77.3	77.3	91.6	103.0	85.3	72.8
32	62.7	83.7	83.7	101.0	116.0	93.9	79.1
33	66.3	90.3	90.3	110.0	130.0	103.0	85.6
34	69.9	97.0	97.0	120.0	145.0	112.0	91.7
35	73.4	104.0	104.0	131.0	164.0	123.0	98.8
36	76.9	111.0	111.0	143.0	182.0	133.0	105.0
37	80.3	118.0	118.0	155.0	206.0	146.0	113.0
38	83.5	126.0	126.0	168.0	235.0	157.0	120.0
39	86.7	133.0	133.0	181.0	261.0	172.0	128.0
40	89.7	140.0	140.0	194.0	290.0	184.0	134.0

Ground Reception

Two New Jersey radio experimenters, Louis Schemppf and Charles Menge, recently caused a little stir in the neighborhood by their announcement of a new type of wire which they claimed permitted them to receive without an antenna. They connected all their receiving apparatus with this wire and used the circuit shown.

They succeeded in obtaining rather good signals without an antenna. The wire was composed of a core of thick enameled wire, around the outside of which were wound two

lengths of thinner wire also insulated with enamel.

They firmly believed that it was this patented wire that was producing the signals in some mysterious manner, but we believe that they would have been able to obtain precisely the same results if they had connected their set up with some ordinary copper wire. The location of some receivers is such that it is possible to receive through the ground and obtain almost as good results as with an aerial.

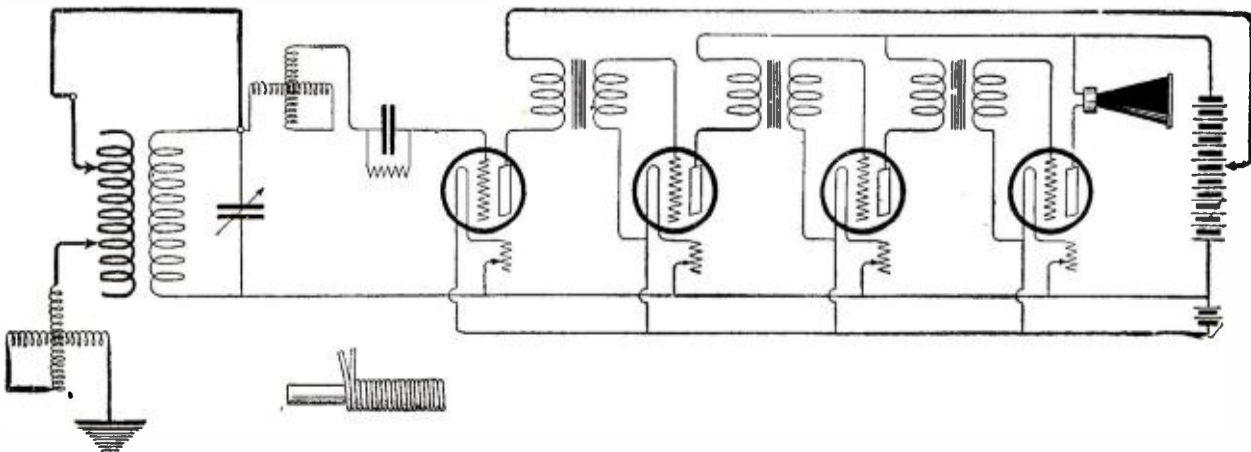

Insert Shows the Type of Wire Used by the Experimenters. Heavy Line Connecting Primary to Secondary Shows Special Connection for Ground Reception.

BARKELEW

Radio "Lead-In Insulators" Stop the Leaks Aerial Currents Are Small at Best

An expensive Radio Set and a good Aerial means nothing unless connected with well insulated wiring.

The rapid growth of Radio Telephony has led to Radio wiring being done by inexperienced persons using unsuitable material. This means Radio trouble, fire hazard and general dissatisfaction.

A rigid inspection program is now under way and all Radio wiring will soon be made to comply with the National Electric Code. The proper use of Barkelew Insulators insures safe and effective wiring with high insulation under all conditions.

For Receiving Station



Catalog No. 612
Price \$0.50

Insulator No. 612 is specially designed for receiving station outside wiring and is ideal for the purpose.

The porcelain while large enough to give ample insulation in all kinds of weather, looks well on any type of building. With this insulator we still hold to the safe separation of 5 inches between wall and wire.

Both types shown herewith are made of Wet Process, high-voltage Porcelain, heavily glazed and mounted on Treated Locust Pins. The Wood Screw only is to be used for attaching to frame buildings and the expansion shield in addition for brick or concrete buildings.

For Transmitting Station

Insulator No. 613 is for transmitting station wiring either inside or outside and is highly efficient for either purpose.

The porcelain is a large petticoat insulator rated at 6600 volts. This insulator spaces the wire 5 inches from the wall as required by the National Electric Code.

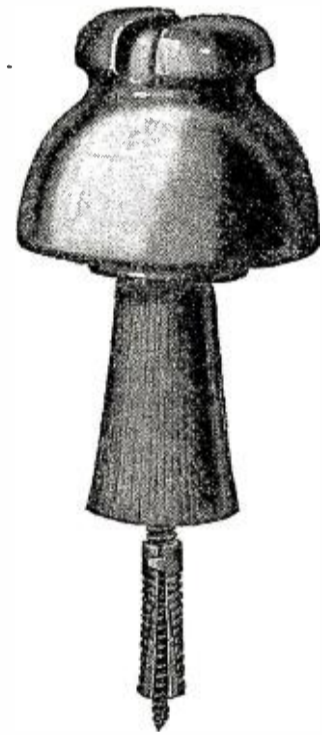

Catalog No. 613
Price \$1.00

This company was organized years before Radio became a commercial possibility. Unquestioned facilities, long experience and an established business policy combine to insure your satisfaction with all Barkelew Radio Products.

Discounts to Electrical and Radio Distributors.

Send for Bulletin No. 28 on "Lead-In" Insulators.

The Barkelew Electric Mfg. Co.

Middletown, Ohio

15 S. Clinton St., Chicago
75 Fremont St., San Francisco

7-9 W. Canal St., Pittsburgh
365 W. 23rd St., New York

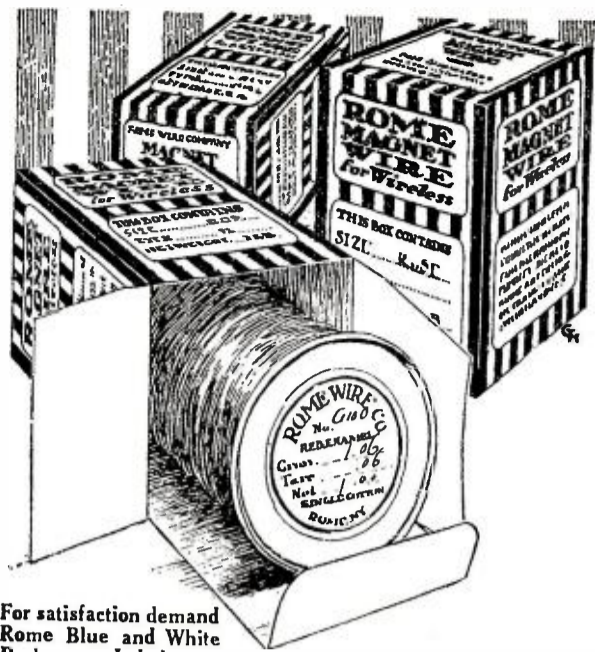

For satisfaction demand Rome Blue and White Package or Label.

ROME RADIO WIRE

Magnet Wire

Best Quality Plain Enamel Covered; Enamel and Single or Double Cotton Covered; Single or Double Cotton Covered.

All sizes: 1/4-lb. to 40-lb. packages.

Antenna Wire

Best Quality Solid or Stranded Copper Antenna Wire, plain or tinned; put up in lengths of 100-ft. and 150 ft., or on 24" reels of 200 lbs.

At Your Dealer's

ROME WIRE COMPANY
 ROME, N.Y. BUFFALO, N.Y.
 DISTRICT SALES OFFICES
 NEW YORK . . . 50 Church Street CHICAGO . . . 14 E. Jackson Blvd.
 DETROIT 25 Parsons Street
 LOS ANGELES J. G. Pomeroy, 336 Azusa Street

VARIABLE CONDENSERS

Plates 1/32 in. Thick Aluminum

43 Plate .001 Mfd.	\$3.75
23 Plate .0005 Mfd.	3.25
11 Plate .00025 Mfd.	3.00
3 Plate Vernier	1.25

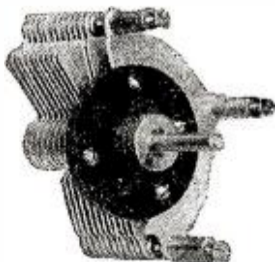

Square Law Type

.0005 Mfd.	\$3.50
.00075 Mfd.	4.50
.001 Mfd.	5.50
.0015 Mfd.	6.50

Balanced Type

.001 Mfd.	\$5.50
.0005 Mfd.	4.75
.00025 Mfd.	4.00

These Condensers embody the best materials, and workmanship, are efficient and for beauty of appearance unsurpassed.

MONTROSE MFG. CO.
 1200 Bedford Ave., Brooklyn, N. Y.

An Efficient Short Wave Receiving Set

(Continued from page 256)

coupler. In wiring the set, No. 14 bare wire should be used, and spaghetti insulation when necessary. Six binding posts will be required for the antenna, ground, phones and filament battery.

The graduations for the filament rheostat and the grid condenser are made by scratching along a straight edge with a divider point, and filling the scratch with white lead.

No details of a cabinet are given, as each will have his own idea as to the size and proportions of it.

A set constructed according to these details, the one shown in the photograph, has given satisfaction for about two years, and on music reception has proved itself to be excellent. With a very large antenna, it will be necessary to use a series condenser to cut the primary wave length down to 200 meters.

Winding and Using Honeycomb Coils

(Continued from page 259)

Add chemicals in order given, soluble cotton being last. Allow to stand 12 hours and strain through cheesecloth.

After the coil has been dipped and is dry, the varnish should be scraped from the contacts and they should always be kept clean and bright. It is a good idea to mark each coil with the number of turns before varnishing.

The mounting for these coils, or, as it is sometimes called, the mechanical coupler, is quite simple as will be seen from the drawing. One coil is mounted stationary while the other is movable for the coupling. The round blocks should be turned same size as the block used in winding. The contacts are thin spring brass. A slot is cut in the side of the block and the contact fastened with a small screw and bent back over the screw after the lead wire has been soldered. It should be quite springy and project slightly from the block, which will insure good contact when the coil is slipped in place. By making the contacts an inch or more long, they will always be in contact with the coil even if it be turned one way or the other in placing it on the block.

The dimensions of the arms need not be exactly as given, but should be long enough to allow the larger coils to be used. An ordinary brass hinge is used on the movable arm; it might be mentioned here that brass screws should be used in all places, as iron screws would have some effect on the working of the coils.

Instead of using a base, the arms may be mounted directly on top of a cabinet, and the knob allowed to project over the panel, which makes a convenient position for operating. If it is desired to use three coils instead of two, it is only necessary to add another movable arm. The stationary coil should be left in the center. Flexible leads must be used on the movable coils and these should be soldered to the contacts. The knob for adjusting the coupling is not absolutely necessary, except in certain hook-ups, where the hands of the operator have a capacity effect.



Economical "A" Battery

The Magno Round Cell Storage Battery is the most economical "A" Battery equipment on the market today. It will deliver practically unlimited ampere hour capacity because you can

Recharge at Home in 1 Minute

To completely recharge the Magno, it is simply necessary to unscrew the cap and insert a "spare" fully charged positive electrode. "Spare" electrodes are exchangeable at your dealers at 25c each. Thus you see there is

No Charging Equipment Needed

The "snare" charged electrodes will never become discharged prior to inserting them in the battery. Thus your service is never interrupted for more than one minute if you keep a "spare" electrode on hand.

Each battery is a 2-volt unit. Any number may be connected in series to obtain any required voltage. Each positive electrode is of 30 ampere hour capacity. Complete description in our folder R-1. Write for a copy today.

Price per battery	\$6.00
Price per positive electrodes	1.00
Positive electrodes exchanged	.25

Dealers, write for discounts today

Every Battery Its Own Service Station
MAGNO STORAGE BATTERY
 - CORPORATION -

AEOLIAN BLDG. NEW YORK

STORAGE BATTERY MAGNO



S-C Loud Speaker Horn

Delivered at any door in U. S. for \$7.50

Largest value on the market.
 22 1/2" high; 8 3/16" bell.

Made of soft brass of remarkable tonal quality, on correct, tested acoustic principles. Takes any radio receiver in universal receptacle. Handsome gold bronze finish, lacquered. Counterweight prevents tipping.

In the same high quality with low prices: Variometers, Variocouplers, Variable Condensers, Amplifying Transformers and other radio parts. Pink-a-Tone Sets, \$25.

Ask for Bulletin R

S-C PRODUCTS COMPANY
 1265 Nicholas Bldg., Toledo, Ohio

OFFICIAL
RADIO BROADCAST MAP
 (In Two Colors) 10 Cents Postpaid
 Experimenter Pub. Co., 53 Park Place, New York

Armstrong Uses Pacent Radio Essentials in His New Super-Regenerative Circuit

WHEN Major Edwin H. Armstrong recently demonstrated his new super-regenerative receiver before the Institute of Radio Engineers, he was able to receive from the famous WJZ station at Newark (25 miles distant) by the use of three vacuum tubes, although only a small loop aerial was used in the steel framed building of the Engineering Societies, New York City. The program was reproduced with

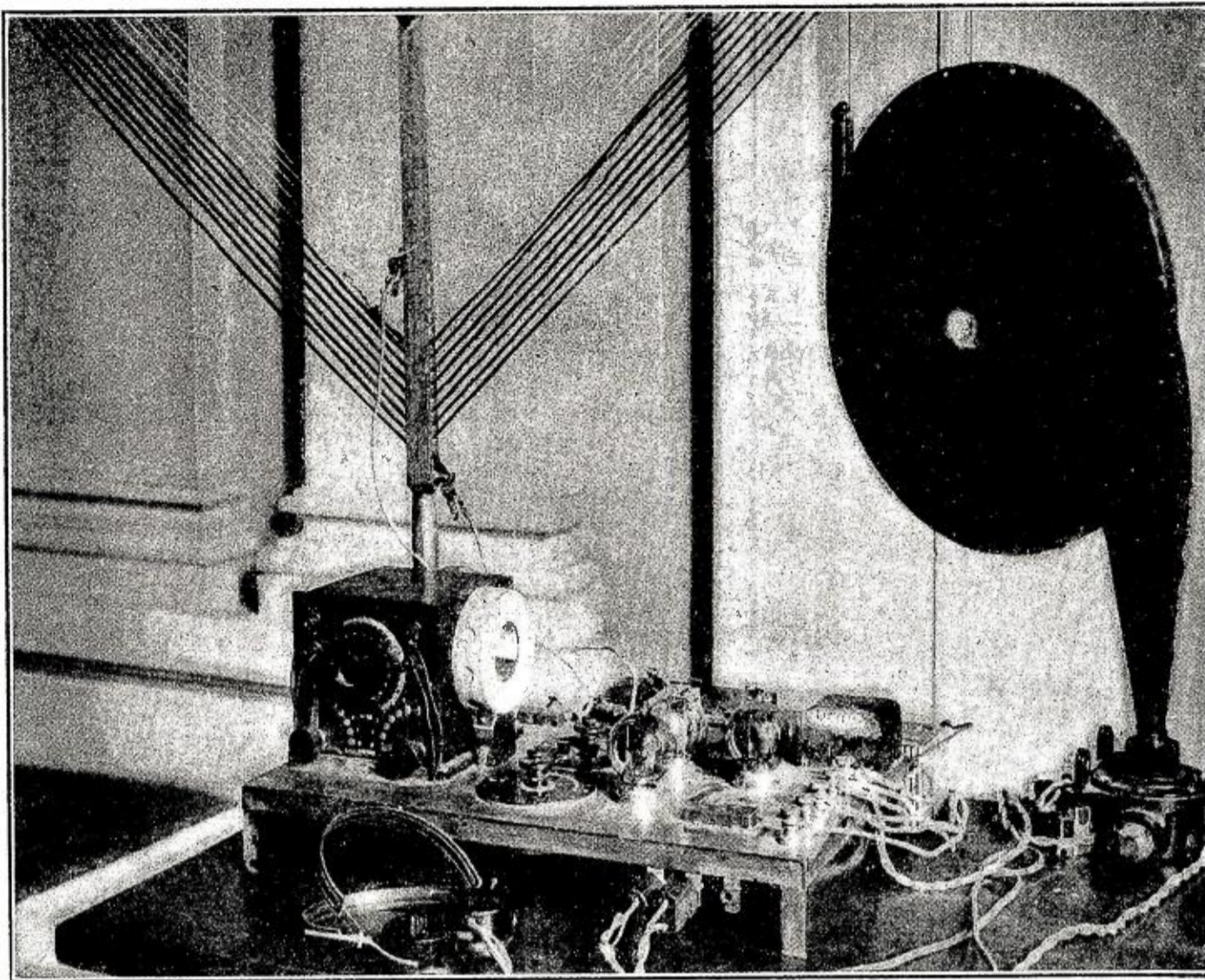

Pacented Equipment used by Major Armstrong to demonstrate his super-regenerative circuit before the Institute of Radio Engineers

such great volume that it filled the lecture hall and corridors.

In his precision radio work, Major Armstrong chose his equipment with the greatest care and with a keen sense of engineering values. **PACENT** Radio Essentials were selected by Major Armstrong because they were of correct design and constructed with honest materials.

ARMSTRONG CHOSE

Pacent Duo-Lateral Coils, as the best suitable inductances for the auxiliary frequency circuits. Duo-Lateral Coils are the last word in inductances.

Pacent Universal Plug, because of the perfect, constant contact they produce, which is absolutely essential in any radio receivers employing extremely high amplification.

Pacent Multijacks, because, aided by the Pacent Universal Plugs, they allow him to make perfect contacts and to rapidly change connections.

Dubilier Micadons, because they have constant capacity and entirely eliminate the noises caused by paper condensers. Dubilier condensers are essential for steady, continuous operation.

Pacent Radio Jacks, because they were designed especially for radio and they form perfect contact with Pacent Universal Plugs.

Pacent Duo-Lateral Coil Receptacles and Plugs, because of their convenience and the perfect electrical contact they form.

Let Pacent Products help you to build up the efficiency of your radio equipment.

Don't Improvise - Pacentize

See the local Pacent Distributor or send for bulletins



PACENT ELECTRIC COMPANY
INCORPORATED

150 Nassau Street

NEW YORK

Member Radio Section, Associated Mfrs. Electrical Supplies

Branches:
PHILADELPHIA, PA.
Bourse Bldg.
CHICAGO, ILL.
33 So. Clinton St.
WASHINGTON, D. C.
Munsey Bldg.

A Step Forward in Variable Condensers

RADIO STORES CORP.

(Manufactured by Radio Stores Corporation)

Type VC-1

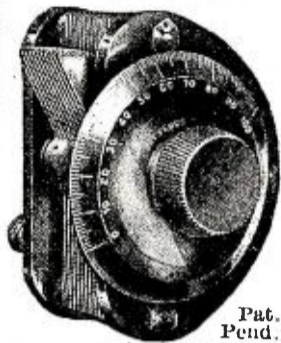

Counter weight under dial. Brass studs through aluminum plates and die cast. Shaft held in true center through brass bushings. Binding posts mounted

on metal straps. No insulating material tapped—metal inserts throughout. Precision workmanship — best engineering design.

List—23 Plate .0005 mfd. \$4.25

Maximum to minimum capacity ratio 12 to 1

43 Plate .001 mfd. 4.75

Maximum to minimum capacity ratio 22 to 1

Complete with Knob, Dial and Counter weight. Each packed in individual carton.

IMMEDIATE SHIPMENTS

DICTOGRAPH

Being Shipped by Us NOW on Quantity Orders

Let The Radio Stores Corporation keep you supplied to meet the growing demand for this popular Head Set.



We Make IMMEDIATE SHIPMENTS!

Wire your orders today

R. S. C. Torpedo Plug

UNBREAKABLE

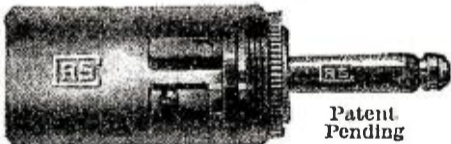

All conductive parts of heavy machined brass, insulated throughout. Screw binding post terminals, with separate anchor for tail of cord. Designed to insure rigidity, durability, strength and lightness.

List. \$1.25

Audio Frequency Amplifying Transformer

LIST \$3.75

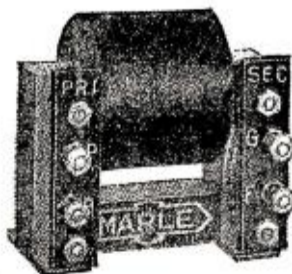

Effective Frequency range, 70/3500 cycles. No distortion or howling as usually experienced. Coil is impregnated and moisture proof. Separate terminal boards for Primary and Secondary circuits prevent current leakage. Used in large quantities by biggest reputable manufacturers of radio apparatus, which establishes its extraordinary qualifications and gives it the best recommendation.

222 West 34th St. New York City

IMMEDIATE SHIPMENTS Ask for Folder N

A Low Voltage Filter for Radiophones

(Continued from page 259)

the type to be used in the secondary circuit of the filament lighting transformer, see Fig. 2.

While transmitting with a radiophone, there is usually a great drop in the antenna radiation, due to the high resistance of the microphone. This may be remedied by shunting the microphone with the secondary of another telephone induction coil. This stunt will also better the modulation considerably. Connections are shown in Fig. 3.

Self-Rectification

(Continued from page 255)

the clips, the taps may be taken off in two rows down the tube, every other turn being tapped in the same row. This method will allow just twice as much room as otherwise would be afforded for the clips.

The condensers C-1 and C-2 are small mica condensers, which may vary in capacity from .002 mfd. to .008 mfd. However they should be very nearly the same capacity, and be able to withstand 4,000 volts each. The condenser C-3 is a mica condenser of from .0005 mfd. to .002 mfd. capacity, and should be built to withstand 4,000 volts. The voltage rating on these condensers may seem excessive when the plate potential from the transformer is only 1,000 volts or less. However, due to radio-frequency surges and other phenomena, very high voltages are sometimes impressed on these condensers. A safety gap properly adjusted and mounted directly on the condenser will save it from being punctured. The condenser C-3 is not essential when working the tubes at their rated voltage, but when they are worked to capacity it is absolutely necessary in order to keep the excessive voltage off the grids. Even when the tubes are underloaded, the use of the grid condenser and proper leak will, no doubt, increase radiation noticeably.

The grid leak R-1 may be a standard resistance, a number of which are on the market, or may be the secondary of a Ford spark coil. With two Ford coils, three possible values of resistance may be obtained: First, the resistance of one secondary alone; second, with the two coils in series; and third, by using the two coils in parallel. A buzzer and battery may be connected in the primary circuit of the coil, which will give I.C.W. through grid modulation. In any event, the high potential terminal of the secondary should be connected to the grid, while the grounded end of the secondary should be connected to the filament.

The choke-coil X-3 is not absolutely necessary, as it merely smooths out the A.C. ripple. However, as it brings the wave nearer to a pure C.W. state, and as its cost is comparatively low, it should be included in a complete outfit. An old transformer core rewound, or a discarded impedance coil will do. A good open-core choke may be made by winding about three pounds of No. 26 enameled wire on a laminated iron core 8" long and 2" square. There are several reactances on the market for those who prefer to purchase rather than build their apparatus.

Since at least two tubes will always be used at the same time, their filaments may be connected in series, and all filament connections run to their mid-point, as Y in Fig. 3. With such an arrangement the filaments may be lit from small toy transformers, which

JEFFERSON

Amplifying Transformers



No. 45

BY ACTUAL TEST JEFFERSON Amplifying Transformers have proven superior to anything now on the market. Try them and note the improvement, the absence of distortion and the clearness of tone.

FURNISHED IN TWO TYPES, either mounted or unmounted. Wound with No. 40 and No. 44 wire on a core of highest grade 36 gauge Silicon steel.

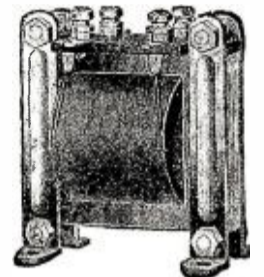

No. 41

Send for Radio Bulletin REASONABLY PROMPT DELIVERIES JEFFERSON ELECTRIC MFG. COMPANY 424 S. Green St., CHICAGO

FINCH RADIO RELAY

(PATENTED AND PATENTS PENDING)

PERMITS YOU TO—

1. AUTOMATICALLY Receive and Record Radio.
2. OPERATE a Telegraph Sounder by Radio.
3. RING a Bell by Radio.
4. IGNITE Explosives by Radio.
5. CONTROL a Moving Vehicle by Radio.
6. OPERATE a Burglar Alarm by Radio.
7. SIMULTANEOUSLY Record and Re-transmit Radio Messages.

Literature Sent Upon Receipt of Stamp

FINCH RADIO MFG. CO.

303 FIFTH AVENUE, NEW YORK CITY

FROM CAT WHISKERS UP—

We can supply everything that's best in Radio, 1 or 101 of any article to user or dealer. Same day shipments.

Inquiries are welcome



DISTRIBUTORS Wholesale & Retail Westinghouse Brandes Federal Murdock, DeForest Radio Corporation and many others

AT EAST PITTSBURGH, PA.—NEXT DOOR TO KDKA

The RADIO-PHONE SALES CORP.

Announce

Long Range Receiving Sets All Units in One Cabinet

TERMS TO DEALERS

Dept. 7S, 770 Old Colony Bldg., CHICAGO, ILL.

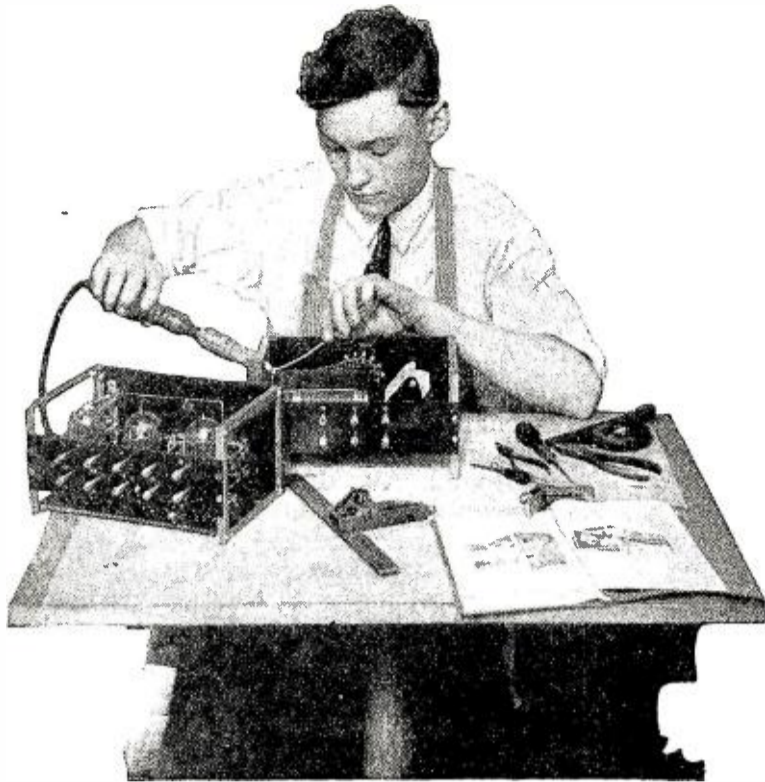

This Experimenter's Set Will WORK

Because he is building his instruments in accordance with the instructions given in

MODERN RADIO RECEIVING SETS

By M. B. SLEEPER

MODERN RADIO RECEIVING SETS, the "Brown Book" and the "Blue Book," are the kind of books that you need, not to keep in the bookcase but to work with every day in your shop. The clear photos, scale drawings, and explicit instructions cover apparatus so simply designed that you can build it in a kitchen table work shop with ordinary tools and standard parts, yet the instruments are so well designed that in appearance and operation they are equal to commercial equipment. And remember that these fifty-cent books cover a dozen different instruments, giving more details than blue prints which sell for a dollar and describe only one device.

"THE BROWN BOOK"

Modern Radio Receiving Sets

50c *Postage 4c*

LIST OF CHAPTERS

- Short Wave and Long Wave Loose Couplers
- 150-3,200 m. Single Circuit Audion Set
- 150-2,600 m. Regenerative Receiver
- Detector and 2-Step Amplifier
- Simple Crystal Set for Broadcast
- Radio Frequency Amplifier
- 12,000 to 20,000 m. Receiver
- 150-600 m. Regenerative Set
- Some Common Radio Problems
- Ideas for the Shop and Laboratory

IMMEDIATE DELIVERY

Radio and Model Engineering Series No. 1

"THE BLUE BOOK"

Modern Radio Receiving Sets

50c *Postage 4c*

LIST OF CHAPTERS

- Short Wave Variocoupler
- Detector and 2-Step Amplifier
- Variometer Tuning Unit
- Universal Timer and Its Uses
- 3-Step Radio Frequency Amplifier
- Audion Broadcast Receiver
- 150-800 m. Loose Coupler Receiver
- 150-1400 m. Receiver and Amplifier
- Tools and Methods of Construction

DELIVERY JULY 15th

Radio and Model Engineering Series No. 2



SLEEPER RADIO CORPORATION

88-N Park Place Successors to THE GENERAL APPARATUS CO., Inc. New York City

RADION



The Ideal Insulation

Every RADION part moulded by us has been designed only after a survey of the needs of the radio industry with a view to our future position in this field, and due regard to the protection of our reputation as oldest and largest specialists in Hard Rubber.

RADION Standard Parts include Panels, Dials, Sockets, Knobs, Insulators, Tubes, Rods, Discs, Bases, etc.

RADION PANELS in black, brown and mahogany are admittedly superior in finish, resistance to warping, and easy working qualities. In insulation value RADION is supreme. Competitive tests by the highest electrical authorities have established this fact.

Dealers will want our RADION illustrated circular, just issued. Write today.

Manufacturers—We are prepared to mould hard rubber pieces in quantity to exact specifications, such as Ear Caps, Condenser Bases, Knobs, etc.

Photographic reproduction showing mahogany grain



American Hard Rubber Co.
11 Mercer St., New York

LATEST RADIO SENSATION

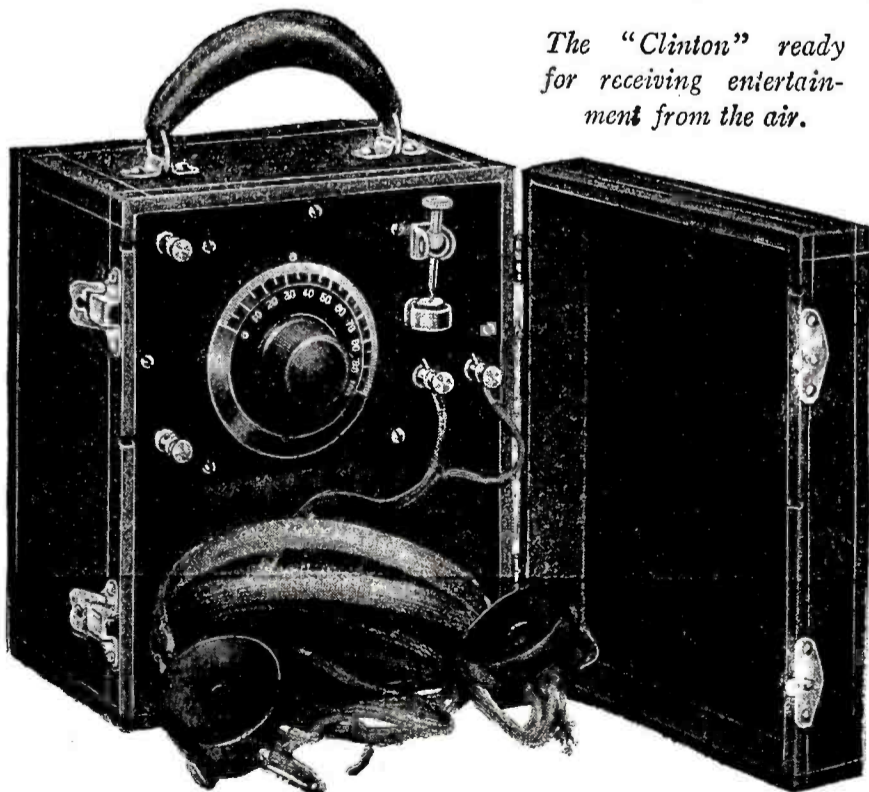

The "Clinton" ready for receiving entertainment from the air.

"THE best crystal Radio set on the market. A sensation to Radio. The neatest, most compact and efficient. Built entirely different. Must be seen to be appreciated. Wonderful proposition to jobbers."

RADIO DIALS

"Three inch polished aluminum dials without knobs. 0 to 180 scale readings.

Price \$12.50 per hundred."

CLINTON RADIOPHONE CO., 29 S. Clinton Street, Chicago, Ill. (Dept. A)

have no center tap from the secondary. If the tubes are connected in parallel, two small mica condensers of approximately .002 mfd. capacity should be connected across the transformer, near the tubes, as shown in Fig. 2, with their center tap connected to the transformer center tap. These condensers are by-pass condensers for the radio-frequency currents which would otherwise be forced through the transformer, possibly damaging the same.

The radio-frequency choke coils X-1 and X-2 are to keep the high-frequency current out of the transformer. With some types of power transformers on the market, these chokes are not essential, but their use is strongly recommended, as they not only safeguard the transformer, but also prevent the radio-frequency current from leaking to ground. A suitable choke may be made by winding one hundred turns of No. 28 S.C.C. wire on a tube 2½" in diameter, and 2½" long.

In setting up a set such as has been described above, it is well to mount the instruments in such a way as to allow the wiring to be as short and as similar to the schematic as possible. All connections in the oscillatory circuits should be short and heavy, with condensers C-1 and C-2 close to the tubes. If a ground is used, it should be connected at or near the filament connection of the inductance in order to maintain the filaments at, or near, ground potential. If a counterpoise is used, to get best results the clips should be placed so as to put the point of zero potential to ground at, or near, the filament connection. The antenna should be connected to the plate side of the inductance, as the power is in this circuit. It is desirable, when adjusting a tube transmitter to reduce the plate potential at least 50 per cent. to safeguard the tubes against excessive currents in case the circuit refuses to oscillate. This may be done by inserting a resistance in the primary side of the power transformer.

How to Build a Loud Speaker

(Continued from page 258)

I have found this loud speaker to give much clearer signals, when handling strong signals, than any other phone I was able to get. It is particularly desirable to have a clear phone, if voice, such as a radio sermon, is being reproduced, and in this case this loud speaker is fine, to have it talk to an audience.

The finish of the piece can be of any desired color or nature. It is well to give the inside of the horn several coats of good varnish to produce a clear, smooth surface for the sound to travel over.

In concluding this article, it might be well to bring out the principle involved in a loud-speaking receiver, or in fact any horn. There is no amplification in the horn, of any nature. The horn serves as the connecting link between the small volume of air, which vibrates with the receiver diaphragm, and the outside air of the room. Any increase of sound, which might seem to the layman as amplified in the horn, is only the result of a better connection, through the horn, between the small volume of air in the receiver, and that in the room.

The Construction of an Ideal Short Wave Receiver

(Continued from page 258)

circuit, using three coils, of course, instead of two.

Briefly, they consist of several turns of wire (preferably Litz) on 5¾" bakelite tubing. The latter need not be longer than 1" for coils up to 30 turns (Litz wire) and the winding is plain single-layer. The diameter of these coils is important and care should also be



24 RB 2 SERIES
Hard Rubber Case

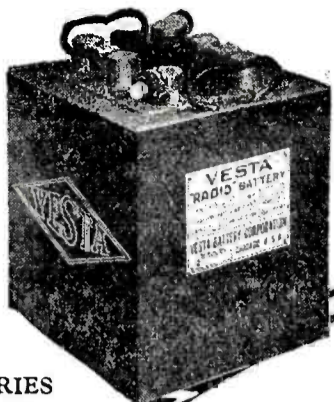

6 EA SERIES
Black Rubber Case

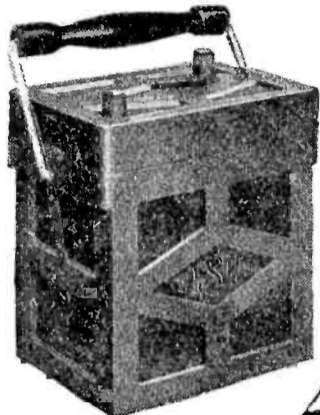

R 6 EA SERIES
Hard Rubber Case



V 6 EA SERIES
Finished Maple Case

VESTA

"A" and "B" Batteries Best for Radio Work

A battery that runs down after a few evenings' work is a poor investment. Save yourself those disagreeable trips to the service station for recharging by using Vesta "A" and "B" storage batteries.

The extra heavy plates used in these batteries enable them to hold their charge over long periods. The current output does not drop at the critical moment you are receiving from some new and far-away point.

Vesta "B" Batteries, too, open up new possibilities of radio enjoyment. They help eliminate those frying noises made by dry cells (sometimes mistaken for static) and greatly increase the radio efficiency of your tubes. Experts who use the "soft" type of detector tube prefer them to all other makes of batteries.

Two to four years' service can be expected from Vesta Radio Batteries if kept watered and recharged when the gravity falls below 1200°. No other attention is necessary.

Vesta Radio Batteries are made in the styles and sizes illustrated. They are of the same sturdy construction used in automobile work, and will give perfect satisfaction. It pays to buy a good battery.

Vesta Service Stations catering to the automobile trade and radio dealers are supplying these batteries. Consult your phone book or write us if you are unable to find a local Vesta dealer.

VESTA BATTERY CORPORATION
2100 Indiana Avenue, CHICAGO, ILL.

PRICES		
No.	Amp. Hrs.	Prices
6 EA 5	60	\$17.50
6 EA 7	80	20.00
6 EA 9	100	23.00
V6 EA 7	80	21.50
R6 EA 9	100	28.00

Vesta six-volt Radio Batteries are made in three styles and three sizes.
The ampere draw of a vacuum tube is approximately one ampere.

24 RB 2 B TYPE \$9.00

VESTA

COSTS LESS PER MONTH OF SERVICE

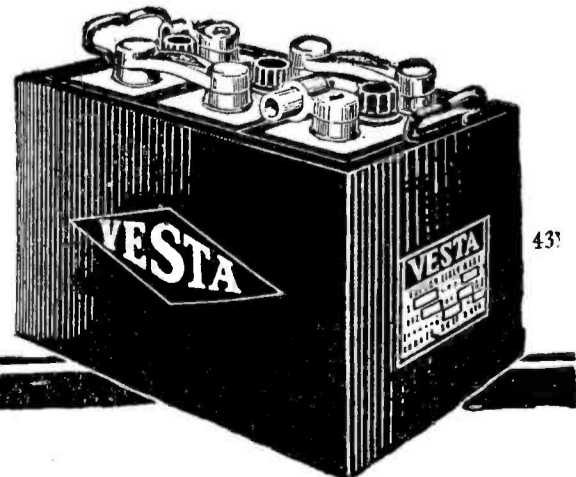



HESLAR Equa-Tone PHONES
Durable, comfortable and efficient. Outside noises eliminated. Register most delicate sounds.

TRADE MARK



Keeping FAITH!

You radio enthusiasts have heard of the many improvements and the unusually fine appearance of Heslar products. NOW YOU CAN SEE THEM! We present Heslar Radio Equipment, knowing positively that it will please you.

Every Heslar product shows last minute improvements that are exclusive. We stand back of every one of them. Go to your dealer NOW. Ask for HESLAR RADIO EQUIPMENT, or—

Write for Catalog and Literature



HESLAR VARIABLE CONDENSERS
23 Plate :: 43 Plate
Designed by engineers with fourteen years experience. Special plates, rounded to enable perfect adjustment at lowest capacity.



HESLAR SOCKETS
Four distinct improvements. Formica posts assure perfect insulation. Blades locked by countersinking in Formica base. Admits all steel base tubes.

HESLAR

RADIO CORPORATION
INDIANAPOLIS U.S.A.

With Heslar Radio, the World's your Neighbor

taken to have the coils all wound in the same direction. The bakelite tubes are fastened to plugs similar to those taken from discarded honeycombs. I use the following coils for waves between 180 and 400 meters: 1 of 6, 2 of 10, 2 of 18 and 2 of 26 turns, respectively. Larger coils can be built, of course, if it is desired to tune to higher wave-lengths. The exact number of turns is best found by experiment and varies, for the primary, with the antenna system used. I use the same number of turns for primary and secondary coil, as a rule.

Referring to the photograph, it will be noticed that the detector tube and its controls are included in the tuner cabinet, contrary to general practice in the design of short-wave sets. This is done in order that the leads (especially those in the oscillating circuit) may be kept as short as possible.

The instruments are mounted on a formica panel 18" by 12" by $\frac{3}{16}$ " thick. Directly behind this and clamped to it is an aluminum sheet 18" by 12" by $\frac{1}{16}$ ". The holes for both should be laid out at the same time and those in the aluminum made about $\frac{1}{2}$ " larger in diameter. This sheet is connected to the ground and is used to avoid capacity effects from the operator's body when tuning. It does this admirably and is well worth the extra work of putting it in.

Below the Sears-Roebuck two-coil mounting for the Groves coils (located in the upper left-hand part of the panel) is a De Forest vernier variable condenser used in series with the primary to tune it. Mine is of .0015 mfd. To the left and somewhat above this is a 13-plate Coto Coil variable across the secondary and tickler. Below this and shunted across it is a vernier condenser, made by setting a Connecticut variable at half capacity. It is used to get the very desirable fine-adjustment.

The tube with the filament switch and rheostat below it comes next on the panel. The V. T. is behind a $1\frac{1}{4}$ " hole in the panel. To give the hole a finished appearance, a nickel plated brass ring, turned in a lathe, was fitted into this hole. If no lathe is available, several small holes may be drilled in the form of a plus sign in the panel, which will serve the purpose. A piece of glazed glass is located behind the hole, also for appearance. The rheostat is a Wilcox with a home-made vernier attachment, operated by pulling the knob out and turning. It was quite a difficult task to make this attachment, and since rheostats may now be procured with it already in place, it would be advisable to buy it directly from the manufacturers. In the upper right-hand part of the panel is the plate variometer and below it is an Amrad vernier variometer (in a Connecticut Condenser case) which is in series with the main one. The plate variometer can be any well-made instrument such as the Tuska or Remler.

The tickler coil, which is in series with the secondary, consists of about 30 turns of Litz wire on a formica or bakelite tube about 3" in diameter and 1" long. The coil is fastened as near to the variometer as possible and should be wound so that the direction of its winding is the same as that of the outside or fixed coil of the variometer. The exact diameter of the tickler coil will depend on the type of variometer used and should be nearly the same as that of the fixed coil of it and yet be large enough to allow the rotor to turn freely in it. The distance between the variometer and the tickler is fixed.

The binding posts on the left-hand side of the panel go to the aerial and ground. Those on the right-hand side, to the phones or amplifier, as the case may be. It is unnecessary to provide a by-pass condenser to go across the phones, or phones and "B" battery, using this circuit, as neither phones, filament battery, nor plate battery are in the oscillating circuit: The binding posts for the "A" and "B" batteries may be put upon the front panel if desired, but I have mine on a small one fastened to the base of the cabinet.

Knowing where the various instruments are



5c Each

TRADE **HPMCO** MARK
Reg. U. S. Patent Office

Radio Products With The Exclusive Features

DUPLEX BINDING POST CLIPS
Each spring brass clip adds one extra connection to a binding post. Especially useful for hooking up extra phones.

NO. 20 FIXED CONDENSER
.001 M. F. D. capacity. Made of high dielectric, processed varnished paper and tested at 110 volts. The high dielectric value of moulded condensers makes them most efficient for use as phone condensers and in grid circuit. This has been proved in the Trans-atlantic tests conducted by our foremost engineers.

Hedden Place Machine Co.
OFFICE AND FACTORY
40 HEDDEN PL., E. ORANGE, N. J.



Condensers Detectors
Knocked-down Detectors
Tuning Coils, Etc.
At All Good Dealers

Each, 70c

KEYSTONE VARIABLE CONDENSERS

21 Plate, \$3.55

43 Plate, \$4.50

Our selection of materials and built-up type design give assurance of low energy loss and high efficiency

Agents and Jobbers write for information

KEYSTONE MOTOR COMPANY
OAKS, Montgomery County, PENNSYLVANIA



Complete Radio Enjoyment

is obtainable only where high-grade, efficient Radio apparatus is employed. In order to be sure that you haven't overlooked anything that will give you the most Radio enjoyment, comfort and efficiency, equip your receiving set with



No. 2-A—Radio Head Set
Price, \$7.50

Stromberg-Carlson Radio Parts

STROMBERG-CARLSON "Radio Head Set" fits comfortably, is quickly adjusted, has unexcelled tonal qualities and reproduces the faintest long distance signals.

STROMBERG-CARLSON "Universal Radio Plug" should be attached to every Head Set—fits any standard jack—takes any type or size of conductor and takes wire loops, tinsel loops, pin tips or spade tips.

STROMBERG-CARLSON "Radio Jacks" are adapted to all standard Radio Plugs. They mount neatly without washers, on panels of varying thickness between 1/8 in. and 1/4 in.

STROMBERG-CARLSON Radio Parts are made by a concern with 28 years' experience in designing and producing radio and telephone apparatus.

Order Stromberg-Carlson Radio apparatus through your electrical merchandise dealer, or write for free Bulletin No. 1029-R. N.

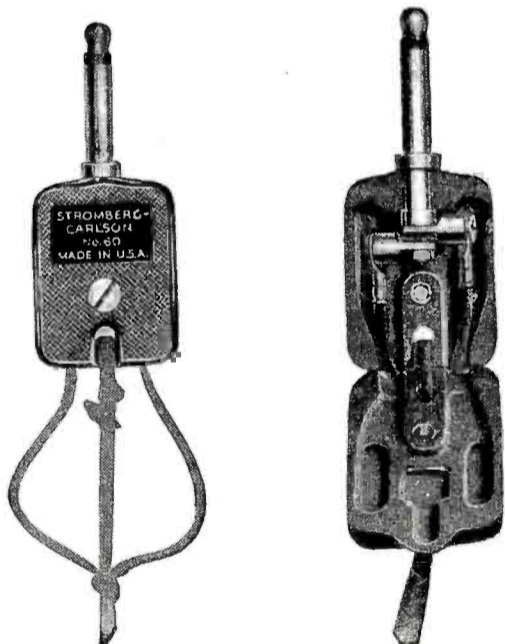

No. 60—Universal Plug
Price, \$1.25

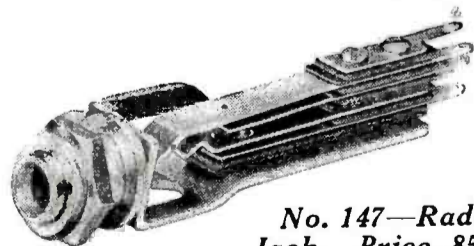

No. 147—Radio Jack. Price, 85c

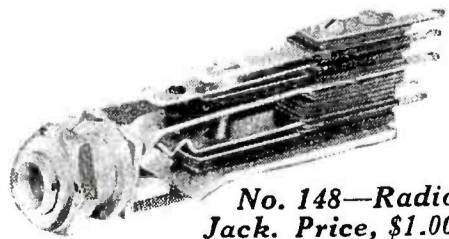

No. 148—Radio Jack. Price, \$1.00

Stromberg-Carlson Telephone Mfg. Co.

Rochester, N. Y.

Chicago

Kansas City

Address nearest office

DX Radio Frequency Amplifying Transformers

Bring in Long Distance RADIO CONCERTS

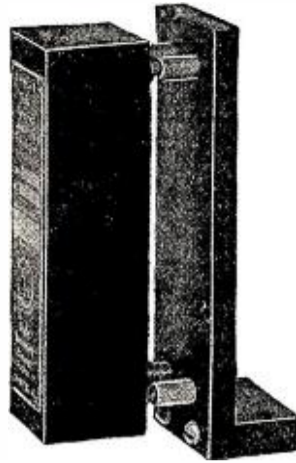

USING INDOOR COIL AERIAL

Remarkably efficient over whole wave length range of transformer; uniform results over wide range of wave lengths.

DX RF Amplifying Transformers simplify the circuit; reduce cost of equipment; improve reception; make tuning less difficult

Eliminate summer static by using DX Transformers with coil aerial

Send Stamp for Bulletin No. 12
RF Amplifier Circuit Diagram 25c.
Curves and Data on Coil Aerials 50c

	Wave length Range	Price
DX-1	170—450.....	\$8.00
DX-S	400—1200.....	8.00
DX-2	900—3000.....	8.00
	Standard Plug Mounting...	1.00

DX RADIO FREQUENCY TRANSFORMERS
SOLD THROUGH RELIABLE DEALERS
AND JOBBERS. (Dealers write for details.
It PAYS to carry the BEST.

Higher Range Transformers Manufactured to Order

RADIO INSTRUMENT COMPANY

WASHINGTON, D.C.

(If your dealer does not have DX RADIO FREQUENCY TRANSFORMERS write us.)

THE STORM-LEE MULTIPLEX ROTARY SWITCH

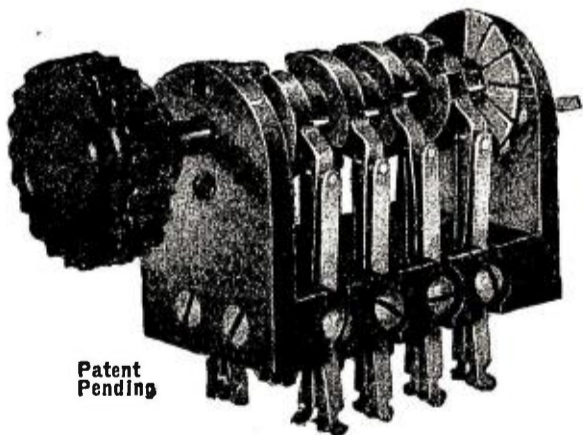

Patent Pending

JOBBERS - DEALERS

This switch is revolutionizing amplifier construction, owing to convenience of operation. It will be to your advantage to write for our attractive proposition.

MANUFACTURERS

Why not use this switch in your sets? Write for details.

STORM-LEE RADIO APPARATUS CO.
742 HIGHLAND AVENUE NEWARK, N. J.

The Perfect Amplifier Switch, Gives Complete Control of Detector and 1, 2 or 3 Stage Amplifier, Including Automatic filament control.

The MULTIPLEX ROTARY SWITCH takes the place of filament control jacks in the vacuum tube control panel, giving much greater convenience at lower cost. With this switch you may change from detector to any desired stage of amplification by merely turning one knob. Filaments of unused stages being automatically extinguished.

UNIVERSAL IN USE

This switch is adjustable, by loosening one nut the cams may be adjusted to meet practically any switching requirements.

SPECIFICATIONS

INSULATION—BAKELITE
SPRINGS —NICKEL SILVER
CONTACTS —STERLING SILVER

RICE - - - - \$5.00

If your dealer cannot supply you write us, giving his name.

located on the panel, a careful examination of the photo, with the circuit used kept in mind, will show that the instruments are arranged so that the connections throughout the set are kept as short as possible in order to minimize the current losses. For the same reason, the set is wired with copper strip $\frac{3}{8}$ " wide. This has over twice the carrying capacity (for high frequency currents) of No. 10 wire, and is much easier to handle and solder. It probably has more surface than is necessary, but it is far better to have too much than too little. Of course, ALL connections should be well soldered.

I am giving no instructions for mounting the instruments on the panel, as they would be of no use to amateurs using different makes of apparatus. Each amateur likes to use whatever he may have on hand, when constructing new apparatus.

It will be observed that all the instruments are provided with verniers (except the coupling of the Groves coils, which seldom has to be changed and then the extension arms provide ample means for obtaining any fine adjustments that may be found necessary). On a set of this type, these vernier controls are very desirable and greatly facilitate tuning in C. W. and phone. No verniers of the mechanical type which operate on the dials, etc., are used, as they are not nearly so satisfactory. The large knobs and extension handles were provided in order to make quick tuning possible.

This set is very selective and if it is desired to use it for broad tuning, short-circuiting the tickler coil will decrease its selectivity quite a good deal, accompanied, however, by a decrease in signal strength.

After the coils for a given range of wavelengths are in place, the only adjustments that need to be made are the primary and secondary condensers and the variometer (although the primary condenser requires but little adjustment). The verniers, of course, should be used when greater selectivity or audibility is desired.

The main difference between my set as here shown and the picture of it in the January issue of RADIO NEWS, is in the re-arrangement of the apparatus so as to have very short leads, which included incorporating the detector in the tuner cabinet for this purpose. A slight change was also made in the circuit.

Phone and C. W. stations come in especially well with this set. Using two stages of amplification, the University of Wisconsin station (about 600 miles from here) came in loud enough, recently, to be heard all over the house, when sending phone, C. W. and spark stations have been heard from much greater distances, of course. All the districts have been heard except the 7th.

I do not think anyone installing a set similar to the one described would ever have any reason to regret it. I realize that it is a little more difficult to build than the usual run of variometer regenerative sets, but this is more than compensated for in the result.

Radio Cabinets

(Continued from page 257)

plane, you are liable on a small box of this kind to do more damage than good, so thorough sanding with coarse sandpaper is recommended, to be followed by fine paper. All sanding should be with the grain of the wood. Corners should be rounded slightly, as they are likely to be knocked off otherwise.

After sanding the box, scribe or mark a line around it to serve as a guide by which to saw off the top. This should be far enough down to allow for the dials, as before mentioned, and also to allow for planing and smoothing up edges after it is sawed off. Be sure to see that there are no nails on the line and then saw off carefully with a fine-

A M P E R I T E

AUTOMATIC FILAMENT CURRENT ADJUSTER

Eliminates Rheostats. Guaranteed to operate your vacuum tubes at maximum efficiency

Price \$1.10 mounted

Manufacturers RADIALL CO., 99 Warren St., New York

Science is Explaining

the delicate action of the audion bulb

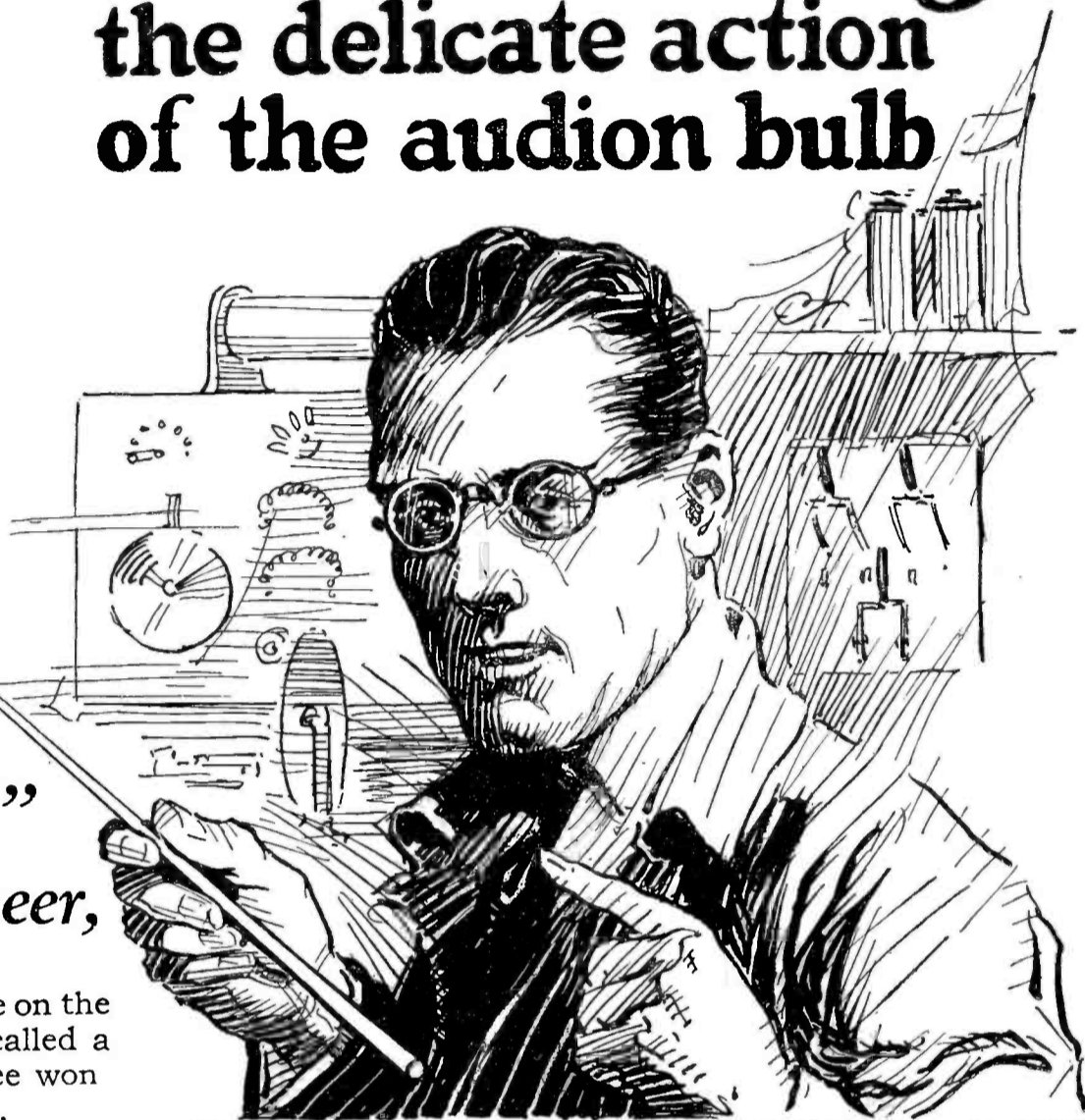
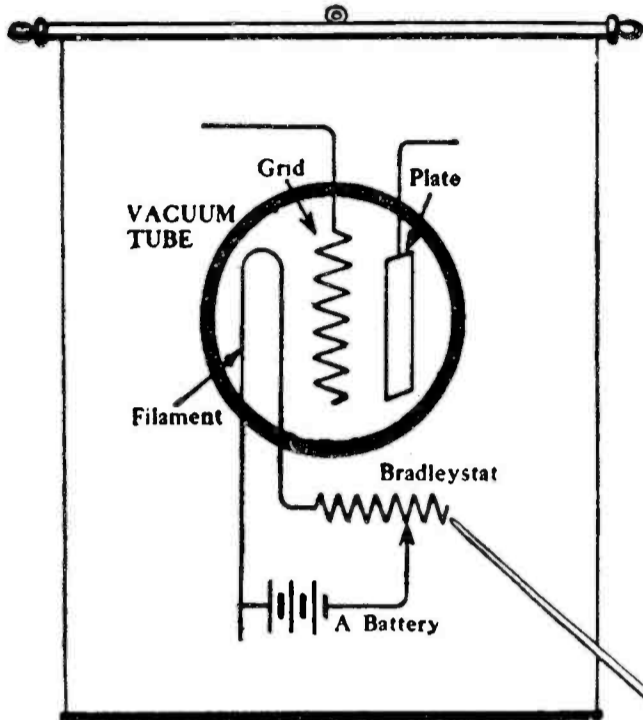

"This is the vital part," says the radio engineer,

"of the receiving set. The heavy circle on the chart is the audion bulb, sometimes called a detector or vacuum tube. It has three wonderful parts—filament, grid, and plate.

"The filament becomes white hot when connected to the "A" battery, and sends out a fairy rain of invisible, electrified particles, which pass through the grid and strike the plate just as a spring rain is driven through the bare twigs of a hedge fence.

"The telephone receivers detect the slightest variation in the rain upon the plate. The broadcasting waves run from the antenna to the grid and interfere with the fairy rain like the leaves on a hedge interfere with a summer shower. So you see, by interfering with the fairy rain, the broadcasting waves make the telephones sing and talk.

"Since it is the fairy rain from the filament which does the trick, it is all-important that you provide noiseless, stepless, and extremely accurate control of filament current. The success of your set will depend upon the quality of your filament rheostat."

For further information, address

Allen-Bradley Co.

Electric Controlling Apparatus

287 Greenfield Ave., Milwaukee, Wis.

Manufacturers of graphite compression rheostats for 20 years

Bradleystat

REGISTERED U. S. PAT. OFF.
PERFECT FILAMENT CONTROL



Retail Price

\$1.85

Postage 10c extra

A single knob applying pressure upon graphite discs provides the amazingly accurate and noiseless control of the Bradleystat. No wire coils, no sliders, no verniers, and no loose contacts to "fry." And above all, the most precise control is available.

The Bradleystat is without equal for filament control of 1/2 and 1 ampere receiving tubes and sending tubes up to 2 1/2 amperes. A guarantee of one year against factory defects is back of every Bradleystat.

Distributors of
"DISTINCTIVE RADIO APPARATUS"

THE ROBBINS CONDENSER

Robbins
 23
 Plate
 Variable
 Condenser
 \$3.25



Robbins
 43
 Plate
 Variable
 Condenser
 \$4.00

Robbins 3 Plate Vernier Condenser, \$1.50

Die cast and mounted on special alloy bearings, ROBBINS VARIABLE CONDENSERS never lose their alignment

Send for Complete Price List

**Robbins
 Electric Co.**

Established 1890

Pittsburgh, Pa.

toothed saw. If a band saw is available it will save considerable time.

Carefully plane up the edges of both the top and bottom of the box and try to get an accurate fit on all sides. Then sand edges and you are ready to fit the hinges.

Use light brass butt hinges about 1" long by 3/4" wide when open. Clamp the top and box with back edges together, as shown in Fig. 4; apply hinge as shown in Fig. 4, on the right. Mark and cut out for hinge as shown at the left of the same figure. Use care in locating and fitting hinges, as they will have much to do with the appearance of the finished box. If it is necessary to move the hinges, plug up screw holes with match-sticks before starting screws in new position.

Small triangular strips may be put in the corners of the box, as shown in Fig. 2, both to strengthen the box and to support the panel and receive the screws that hold it down. These strips should be glued in and need not be nailed, if they fit well in the corner and if good glue is used.

You are now ready for the finish, which will depend upon the wood used to a large extent. If mahogany, the best results will be obtained by the use of a water stain. These stains can be had from various firms on the market.

Antique mahogany water stain is a beautiful reddish brown stain and one ounce will make a quart of stain.

As water stains lift the grain of the wood, it is best before staining to go over the

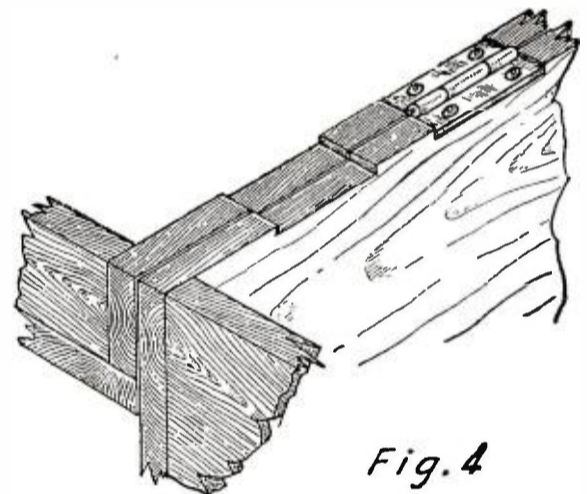

Fig. 4

How to Mount Hinges on a Cabinet.

**A MARVEL OF
 SIMPLICITY AND PERFECTION**

THE SHELL SHAPE DOES IT

THE *only* amplifier built on the correct sound projecting principle and according to laws of acoustics. No tubes to muffle the sound—no horn to distort and destroy delicate notes. Splendid results on both one and two step amplifying sets. Substantially made of heavy aluminum—beautifully designed—highly polished. Portable. Only 8 1/2" high. Use your own standard receivers. Send for descriptive circular.

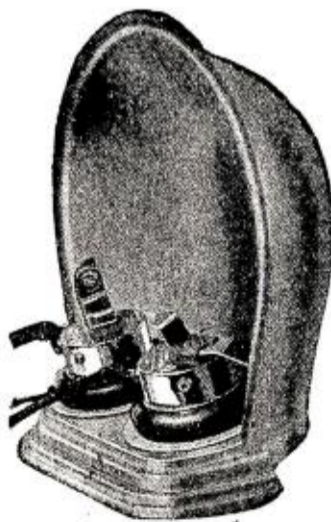

Patent Pending

Price \$5.00 at your dealer or by mail

Special Proposition to Dealers and Distributors

**SHELTON
 LOUD SPEAKER**

\$5

SHELTON RADIO SALES CO.
 20 CLINTON ST., NEWARK, N. J.

\$5

box with clear water, applied with a brush or with cotton waste. When dry rub down with fine sandpaper to smooth down the raised grain and stain with the water stain, mixed in the proportion of one ounce to one quart of water. If you prefer to use oil or spirit stain, you will not need to give the box the preliminary water treatment, as these stains do not raise the grain. They do not as a rule give quite as beautiful or lasting colors as the water stains, however, and are more expensive.

To present a good appearance, mahogany must be filled. Buy a pound can of dark filler, or if this is not to be had, get light filler and color with burnt umber to a dark brown. Thin the filler with turpentine to the consistency of thick cream, and brush it over the outside of your box, rubbing well into the pores. Don't worry about how it looks, just smear it on thoroughly. In a few minutes when the surface of the filler dries out and becomes dull, rub off with shavings or burlap, rubbing across the grain so as not to lift the filler from the pores of the wood. Then moisten a soft cloth with turpentine and go over the surface lightly to clean off thoroughly all filler except that in the pores of the wood, as filler left on the surface of the wood will give a muddy appearance when finished.

After the filler has thoroughly dried, go over the box, both inside and out, with a light coat of orange, thinned with about an equal quantity of wood or denatured alcohol. The shellac will bring out the color that you

The **BENWOOD** Co. INC.

RADIO

"WORLD-WIDE MAIL ORDER SERVICE"



Interior View of Our St. Louis Retail Department

Get Acquainted—

with the Benwood Company and the dependable radio apparatus we manufacture and supply. Established November 1, 1919, we have been in constant touch with all the latest developments in the radio field—we know from actual experience the apparatus that will give highest satisfaction and confine our efforts to handling only the best. Every item in our catalog has been thoroughly tested by radio experts and we guarantee your entire satisfaction or refund your money without any red tape. You can depend on "Benwood" radio parts or sets to get best results.

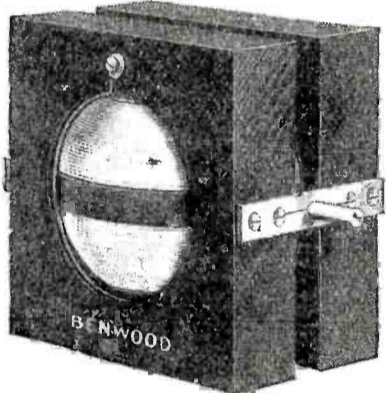

"Benwood" Variometers

PROPERLY designed and constructed, large d.c.c. wire used and no shellac, paint or varnish allowed to cover the wire and diminish the effectiveness. Minimum distributed capacity, minimum distance between stator and rotor, positive contacts. Will give splendid results on wave lengths from 150 to 650 meters when used with any standard variocoupler. Price, each..... **\$5.00**

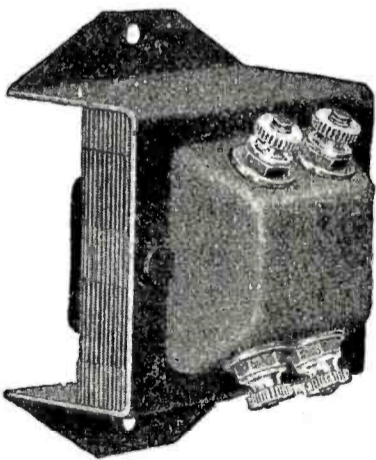

"Benwood" Transformers Audio Amplification

COMPLETELY sheathed in metal, avoids all inductive effects and gives full 4 to 1 amplification without howling or squealing. Base is 2 5/8 x 3 3/8, height only 2 inches—ideal for either base or panel mounting. The core is best laminated steel giving highest transference of energy. Use it with any amplifier tube and get strong, clear signals. A good investment at, each..... **\$4.50**



The "Benwood" Dial Controls

A VERY important feature of these dials is the solid Bakelite Knob of extra large diameter, which minimizes all body capacity effects. The new tapered design fits the fingers of the operator perfectly and the knurling is particularly fine and sharp, affording an excellent grip. They lie perfectly flat against your panel and will not warp.

Solid Bakelite Knob and Dial

Highly polished, solid molded Bakelite throughout. Graduated 0° to 100°—all markings clearly defined in white and stamped into the solid Bakelite—won't wear off. Stops on reverse side prevent turning too far. Set screw deeply countersunk and easily reached.

- BC-7 "Benwood" Control—Diameter, 4 ins.; depth, 1 3/4 ins.; knob, 2 ins. at base, each..... **\$1.75**
 - BC-8 "Benwood" Control—Diameter, 3 1/4 ins.; depth, 1 3/16 ins.; knob, 1 3/8 ins. at base, each..... **\$1.50**
- Specify whether 1/4 in. or 3/16 in. drilling is required.

"Benwood" Binding Posts

AS shown, these have the tapered, knurled solid Bakelite grip which fits the finger tips and matches the dials shown above. Exposed metal part highly nickel-plated. Diameter 7/8 inch. Complete with two washers, each..... **20c**



"Benwood" Vacuum Tube Sockets

Solid Bakelite

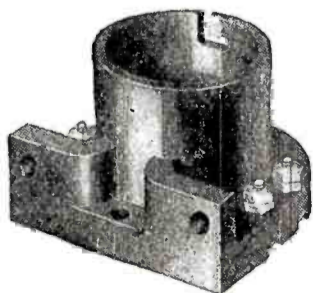

SOLID, highly polished, molded Bakelite, specially designed for either base or panel mounting—the only one of its kind. Firmly holds any standard four-prong detector or amplifier tube. Minimizes ground hum and noises in operation of amplifiers. Terminal posts plainly marked. Base is 2 3/8 inches square, height, 1 1/2 inches. **\$1.00**

A good buy at.....

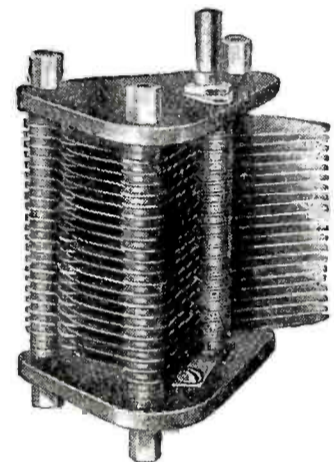

"Benwood" Condensers

43 plate — .0011 Mfd.

THE "Benwood" Variable Condenser has the greatest capacity for its overall size of any condenser made—note the improved stationary plate design. Single bearing, wiping contact assures positive connections. Heavy aluminum plates will not bend or buckle and spring balance holds rotary plates firmly in any position. Bakelite ends assure proper insulation. Panel or table mounting. Complete as shown..... **\$4.50**

The Benwood "Universal" Condenser Shown Below

AN assembly of mica washers and thin copper plates with lugs attached held together by two brass end plates and machine screw through center as shown. Use 2 plates for grid and combine grid leak as illustrated, 10 plates for phone, 35 for filter, or vary to get best results. Standard set of 6 plates and 10 washers, capacity .0005 Mfd., per set.... **75c**
Extra set of 10 coppers and 10 washers (capacity approximately .0005 Mfd.) per set..... **40c**

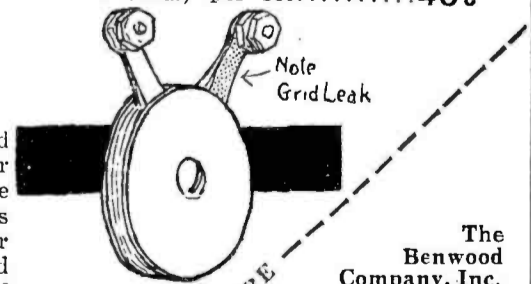

The Benwood Company, Inc.
1111 Olive St.,
St. Louis, Mo.

CATALOG: Send 10c in stamps for the list, also complete catalog and price list of De Forest radio equipment.

DEALERS: We manufacture a complete line of radio apparatus. We have stock on hand and ready to ship. Write or wire for our attractive proposition. New price list issued June 15th.

THE BENWOOD CO., INC. 1111 OLIVE STREET ST. LOUIS, MO.

Name.....
Address.....
City..... State.....

RADIO MEN WANTED

THE world's new industry is radio, which is progressing at a pace that has outstripped all records. Today everyone is concerned with wireless development, from the youngest boy, building his own crystal receiving set, to the largest electrical corporation, making expensive commercial apparatus. Radio is the world's safeguard of the seas. It spans the oceans, links the continents together, and brings to the smallest hamlet the intelligence of the world. Radio is the latest means of communication, a public, world-wide utility, romantic in its operation and as unlimited in possibilities as is the mind of man.

Get in this new industry today, while it is still in the growing period, while the greatest opportunities are offered to men of intelligence and initiative. Today there are not enough trained men to go around. Men, men, and more men, is the cry. The radio industry today needs YOU.

The one best way in which to touch this industry at its very center is through the course of study of the Radio Institute of America, a course that has been developed steadily with the industry during the past fifteen years, and has turned out over 6,000 trained men, 95 per cent. of whom have engaged successfully in this new branch of science and industry.

The graduates of the Radio Institute of America enjoy an exclusive advantage because of the close relation existing between it and the Radio Corporation of America, the world's largest wireless organization, operator of the Long Island Station, that is heard round the world.

Among the thousands of Radio Corporation employes, on ships and ashore, in offices, factories and laboratories, are many former students of the Radio Institute. Think what an advantage it gives you to be able to say: "I am a graduate of the Radio Institute of America."

The Radio Institute of America offers two courses of instruction, one in classrooms and laboratories, to those who can attend personally in New York, and the other by mail. The mail course is skillfully worked out and exactly parallels the personal course. Each student of the Home Study Division has personal attention given to his progress by the experts of the Institute; he loses nothing by not being in New York, and gains by living at home. Code instruction at home is rendered possible by an ingenious automatic transmitting device, variable in speed, so that the beginner learns the code as fast as he is able, exactly as if an instructor sat at his side.

There is a booklet which we send free to you—"Radio, the New Field of Unlimited Opportunity." Send for it and learn more about the extraordinary things that Radio offers to all men of energy and ambition. Send for it today.

Thousands of operators and executives all over the country, both in and out of the Radio Corporation, know what that phrase means. They know that it means that the man who says it, is trained in every phase of wireless—spark, arc, continuous wave, interrupted continuous wave transmitters, the design, maintenance and repair of transmitting and receiving equipment, storage batteries, motor generators, code sending and receiving, operation of the radio telephone, radio goniometry (direction finding), radio laws and regulations.

Everything necessary for making you a successful man in this new and tremendously important radio industry is taught you by the Home Study Course of the Radio Institute of America.

Radio, the newest development of the electrical industry, offers bigger things than the world has yet seen to those who will begin now to help work those things out to success. Will you be one of those who will forge ahead with this new industry?

HOME STUDY DIVISION

Radio Institute of America

(Formerly Marconi Institute)

324 Broadway, New York

may expect in the finished cabinet, so you can now mix putty to match this color for the nail holes. Get a little red lead and burnt umber mixed in oil and mix these into a small piece of putty until its color matches that of the cabinet. Fill the nail holes carefully with this. If the putty is mixed properly before the box is shellacked it will probably be a different color from the wood after shellacking. If the putty is too hard, soften with a drop of linseed oil, and if it becomes too soft while mixing, add a little whiting or crushed and powdered chalk.

After the shellac has dried for three or more hours rub down the outside of the box lightly with No. 0 steel wool. Rub only with the grain and be careful not to cut through the shellac at the corners. Dust the box off thoroughly and you will be ready for your first coat of varnish. In order to do a good job of varnishing it is necessary that everything be clean and as free as possible from dust and dirt. Clean the box by going over it with a lintless rag having a little varnish squeezed into it. This will pick up every particle of dust on the surface. Be sure the brush is clean. Pour the varnish through a clean cloth into a clean bowl and keep it covered when not in use. Go over the outside of the box with varnish, brushing it out thoroughly, and applying just as little as you can to cover the surface. Several thin coats of varnish are much better than one heavy one, for if put on too heavily, the varnish will run and will not dry well. Any high-grade light furniture varnish, such as Pratt and Lambert's No. 38, can be used. Give the varnish plenty of time to dry, not less than 24 hours, and if you find it is not thoroughly dry in that time, wait until it is, if it takes a week. Atmospheric conditions and the season of the year will influence the drying of varnish.

When dry, rub down thoroughly with steel wool, as directed after shellacking. This cuts down all small irregularities on the surface and evens it up. Dust off thoroughly and varnish again. When this is dry cut down with steel wool as before. If the surface is now perfectly smooth without depressions from the pores of the wood, enough varnish has been applied. Otherwise give it another coat and rub down again with steel wool. Follow this with a thorough rubbing with pumice stone and oil; powdered pumice stone can be purchased at any drug store. Dip a wad of cotton waste or soft rags in linseed oil and then dip in the powdered pumice and rub on the box. Rub only with the grain, not in circles, and be careful not to cut through the varnish at the edges. When the box has been rubbed sufficiently it will have a smooth uniform surface, but will not have a high polish. If a polish is desired, follow the pumice with rotten stone and oil, and rub until the desired polish is obtained, after which clean the box off thoroughly with a soft rag.

If your cabinet is of walnut, omit staining, but apply the dark filler, shellac and varnish as for mahogany.

If oak is used and a light finish is desired, finish the same as walnut. The dark filler will stain the wood enough to give a pleasing appearance. If a dark finish is wanted use brown or weathered oak stain, depending on color desired, and complete finishing same as for mahogany or walnut. A simple and rather attractive stained finish is obtained by applying mission oak oil stain and rubbing down with cotton waste or rags. Fill nail holes with black putty made by mixing putty and lampblack. This finish may be left without further treatment, or may be given one or two coats of thin shellac. Do not use filler, as the open pores are a feature of this finish.

The cabinet shown in Fig. 3 is of the usual front panel variety. First nail the ends to the back, then to the bottom. The bottom should overlap all around about 1/4". The box will present a good appearance if it is made about 1/8" shorter and 1/16" less

RADIO SERVICE PRODUCTS

THE AMPLITRON

(A Real Loud Speaker)

The Amplitron is a product of the Radio Service Laboratory and has been designed and constructed especially for radio work. This instrument fills the need for a moderate priced loud speaker. It reproduces radio phone speech and music without distortion—equally good for code. No exciting batteries or adjustments necessary. Uses a Baldwin Type "C" single phone. Price (as illustrated)\$10.00
Price, with Baldwin Phone and Cord 16.50

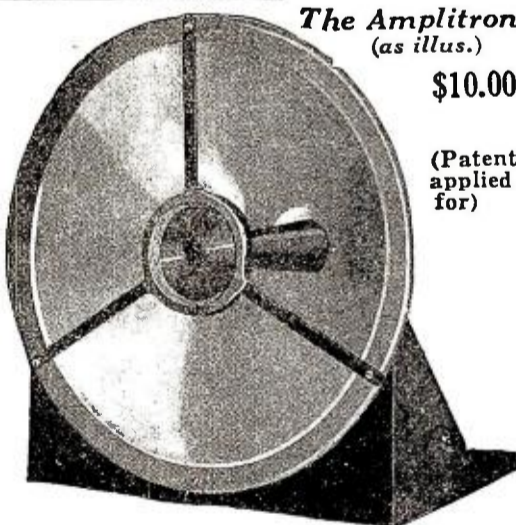

The Amplitron (as illus.)

\$10.00

(Patent applied for)

Other Radio Service Products

- Single VT Sockets Type S10.....\$1.00
- Double VT Sockets Type S3..... 2.00
- Triple VT Sockets Type S4..... 3.00
- 23 Plate Variable Condenser without dial 3.00
- 43 Plate Variable Condenser without dial 3.75
- Grid Condensers .0005 mf. Type S15..... .35
- Phone Condensers .002 mf. Type S16.... .35
- Grid Leak Condensers Type S30..... .50
- Variable Grid Leak Type S40, 1/2 to 3 megohms75

We carry numerous other types of interest to Radio dealers and wireless men. Radio Service Products are for sale by all reliable dealers.

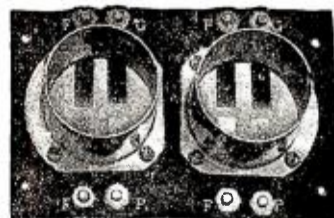

Type S3



Type S10

RADIO SERVICE & MFG. CO.

Factory: Lynbrook, Long Island

Sales Office: 110 West 40th St., New York City

The Book that brings Radio into the home -

WHAT THE BOOK CONTAINS

Section 1. HOW RADIO ENTERS THE HOME. Contains just the information sought by the man who wants to buy a set. What set shall I buy? How much does it cost? What will it do? This section answers a hundred such questions. All types of sets are described from the least to the most expensive. Full installing and operating instructions.

Section 2. HOW TO RECEIVE MOST EFFICIENTLY. Important receiving accessories are described in language that the layman can understand. For the benefit of the amateur, technical data are given on audio and radio frequency amplification, erection of antennae, battery charging, regeneration, etc. Valuable receiving-circuit diagrams are published for the first time.

Section 3. VACUUM TUBE TRANSMISSION FOR THE AMATEUR AND EXPERIMENTER. Everything from A to Z about transmission with new, completely revised transmitting diagrams, incorporating Radiotron transmission and Kenotron rectification. Valuable operating instructions are given, and the use of mica condensers for transmission is emphasized.

Section 4. GENERAL INFORMATION — A VERITABLE GUIDE BOOK TO RADIO. Government laws, National Electric Code Radio Rules, vacuum-tube "Don'ts," radio glossary, specifications for a scientifically constructed amateur station, complete price list of all R C A equipment.



Price
35¢

FOR the first time a book is published at a small price which gives the public all that it should know about radio. It is called "Radio Enters the Home," and it is written by experts. It tells how to enjoy popular radio broadcasting, and it gives complete descriptions of apparatus and installation instructions. No book so richly illustrated, so accurate, and yet so understandable has thus far been published.

The book is divided into four sections. Over 200 illustrations, 112 pages, size 8" x 11". The technically uninformed man will find in sections written especially for him the simply presented facts that he seeks; in other sections are data and diagrams that appeal to the trained amateur.

PRICE, AT YOUR DEALER 35 cents

If your dealer has exhausted his supply, send 35 cents to

Radio Corporation of America

Sales Division, Suite 1802
233 Broadway, New York City

RADIO DEALERS

Send us at once a list of your immediate radio requirements. We are making immediate deliveries on our full line of radio apparatus, parts and accessories.

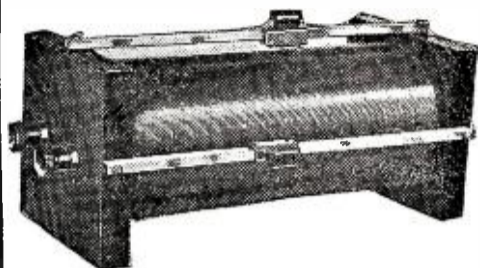

This Tuning Coil tunes up to 900 meters — bare wire — well constructed—list, \$3.75

WE are distributors for the following standard lines of good radio apparatus:

- GREBE DE FOREST
- MURDOCK
- FEDERAL FADA
- HOLTZER-CABOT
- ACME APPARATUS
- A-P TUBES

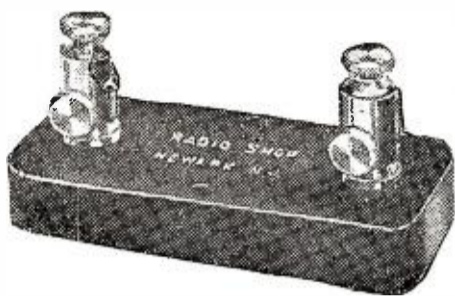

Condenser — .001 capacity — featuring our new double binding post — just what the amateur needs for phone shunting. List 75c

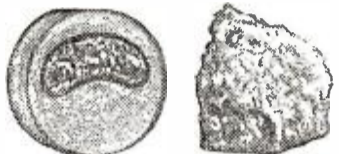

Billion Point Mounted Crystals — the only guaranteed supersensitive mineral on the market—absolutely guaranteed by the manufacturer. Our crystals are used by large radio manufacturers throughout the country. Samples free on request—mounted and unmounted.

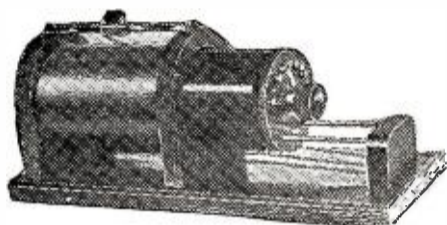

Loose Coupler — 8 taps on secondary—tunes up to 3000 meters —list, \$7.00



Aerial Insulator—list 25c

Immediate delivery—no back orders: Special proposition to dealers—write for particulars

RADIO SHOP OF NEWARK

45 South Orange Ave.
Newark, New Jersey
Dept. V

You Get Stronger Signals

with this new indoor antenna

Springfield 16 Strand Braided Antenna

These two reports are but examples of the way Springfield Braided Antenna is increasing range all over the country:

F. W. Wilbur, Highland Hotel, Springfield, Mass. substituted for his 6 wire cage antenna, 80 ft. of Springfield Braided Antenna on a 1 1/2 ft. square frame, built into a Victrola cabinet. Result—all broadcasting stations copied, as far as University of Minn., a big increase of range. Has abandoned his outdoor 6-wire cage. Equipment, 2 stage Amplifier.

Donald Fancher, Radio 1-B VB, Westerly, R. I., substituted same length of Springfield Braided Antenna for the A wire on his flat top 60 ft. Antenna. Result—1 amp. more radiation, a total of 7 amps. He now hears and works several Canadian radio stations never heard before, and constantly gets letters asking how he increased his range so greatly.

Springfield Braided Antenna is a hollow 16 strand braided cable, about twice the diameter of ordinary cable.

This unusually large conducting surface, and consequently low "skin effect" at radio frequency greatly increases your receiving and sending range.

Retail Price, \$2.50 per 100 feet. Packed in cartons containing 1,000 continuous feet, separated 10 coils of 100 feet each.

Ask your dealer for Springfield Braided Antenna. If he cannot supply you, send us \$5 for 200 feet. No smaller quantities shipped from factory.

DEALERS AND JOBBERS—write for special introductory offer and prices

SPRINGFIELD WIRE & TINSEL COMPANY

387a Main Street



Springfield, Mass.

in height than the panel, which will project slightly all around. Nail and glue the strip across the front of top and glue in corner strips. Hinge back strip and top together before fastening down back strip.

Sanding and finishing will be as already described.

A Simple and Practical Variable Condenser

(Continued from page 257)

The four holes in the base for the standards should then be threaded with an $\frac{3}{32}$ tap, and the two holes, "a" "a" Fig. 3 drilled in the top panel for the binding posts and the two posts "b," drilled in the base to secure the brass strip "J."

The standards are composed of eight pieces of $\frac{1}{4}$ " brass tubing "E" and "H" Fig. 2, through which are placed the $\frac{3}{32}$ brass machine screws "G." These standards serve the double purpose of clamping the top panel and the base rigidly together and supporting the fixed plate "A." It is important that the small pieces of tubing "E" and the large pieces "H" be exactly the same length in order that the plate "A" may present a perfectly flat surface to the plate "B."

The knob "K," together with the bushing "F," was taken from a standard switch unit.

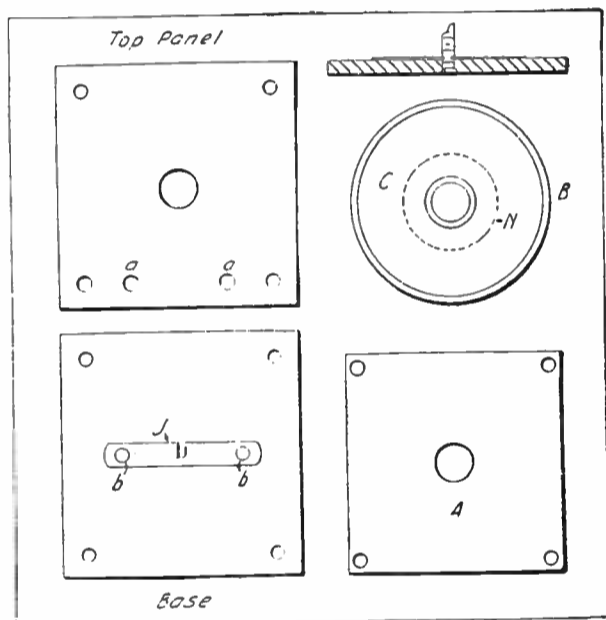

Details of Parts for the Construction of the Variable Condenser.

This bushing should be as long and heavy as possible as it is the main bearing for the screw "D"; it is secured to the panel by the large nut "L." The screw "D" is a length of brass rod threaded with a very fine thread upon which the nut "M" plays. This screw is prevented from moving up or down by the groove cut in its lower end which engages the brass strip "J" see Fig. 3. The hard rubber disc "N" was made from a Wilcox 1" switch knob with the center hole enlarged to $\frac{3}{8}$ ". The spring "P" supplies the proper tension on the nut "M" to force it to travel up or down screw "D" and prevent "M" from revolving.

The fixed plate "A" is of sheet brass. The four holes at the corners are drilled to permit the machine screws "G" to pass through. The movable plate "B" is a standard telephone receiver diaphragm with a $\frac{3}{8}$ " hole drilled through the center. This is secured to the hard rubber disc "N." On "B" is placed a mica washer .005" thick. The thinner this washer is, the higher will be the maximum capacity.

The connection to the fixed plate is obtained by a small brass strip running from the standard to the binding post. In the case of the movable plate, a small flexible lead soldered to the plate runs to the other binding post. A small dial indicator of 360 degrees is attached to the knob and the nut "M" is regulated until maximum and minimum capacity is obtained in one complete turn of the knob.

REMLER

APPARATUS
THAT RADIATES
QUALITY

No. 810

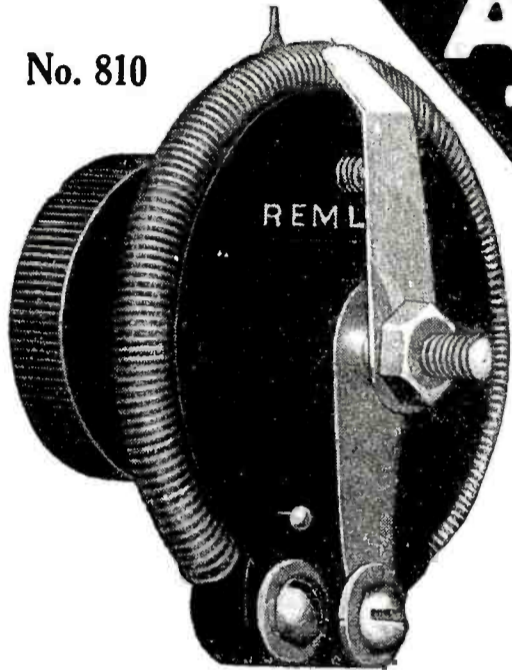

REMLER Jr. Panel Type RHEOSTAT

REMLER Jr. Rheostat No. 810. Resistance unit of 4 ohms with a carrying capacity of $1\frac{1}{2}$ amperes mounted on a bakelite disc 2" in diameter. It is especially designed for filament control of vacuum tubes operating on 4 or 6 volts. The resistance unit is a non-corrosive alloy and can be readily renewed—an exclusive Remler feature. All metal parts are nickel plated and those showing in front of panel are bright polished nickel. An off position is provided, obviating the necessity of a filament switch.

No. 810—Remler Jr., Panel Rheostat, 4 ohms resistance \$1.00
No. 810—RU Resistance Unit Renewal20

No. 92

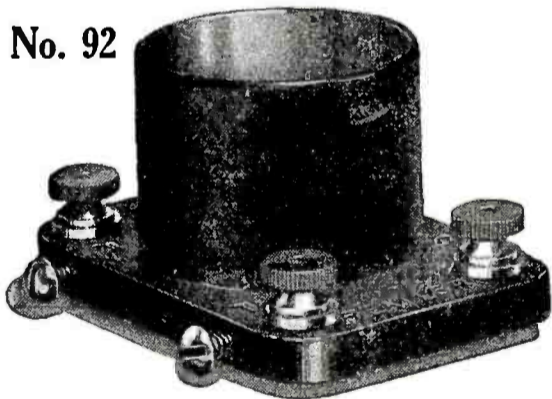

REMLER VT TUBE SOCKET

Panel or Table Mounting

THIS receptacle is designed for all standard 4 prong based vacuum tubes, including the new Cunningham Tubes.

The entire socket is molded from black Bakelite, with a highly polished surface. The base of the socket is of sufficient depth to allow clearance between contact fingers and table.

The contact fingers are nickel plated spring brass. Nickel plated binding post terminals are marked. Nickel plated screws are provided for panel mounting and holes drilled for table mounting. When mounted on panel the tube is set vertically, insuring maximum filament life. Base is $2\frac{1}{4}$ " x $2\frac{3}{4}$ ", and the height $1\frac{1}{2}$ ".

No. 92—Remler VT Socket, Panel or Table Mounting \$1.00

No. 100

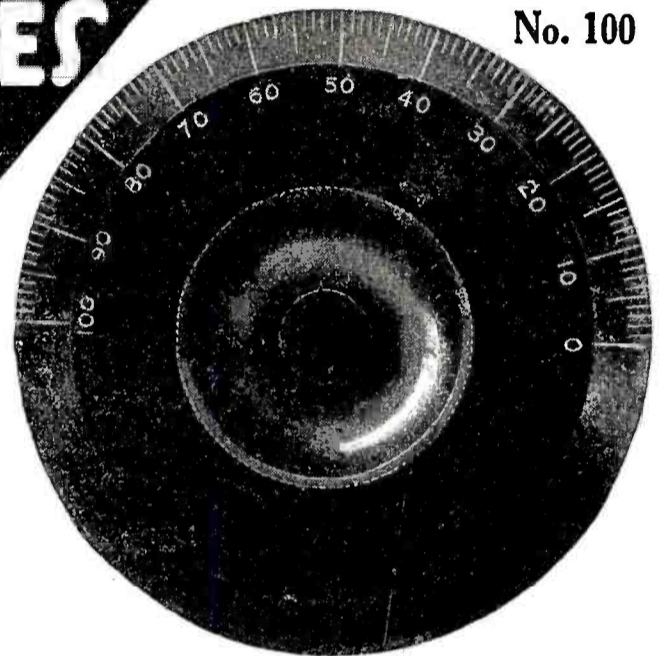

REMLER BAKELITE DIAL

THIS Remler 3" bevel edged dial is molded and ground true from genuine bakelite and will not warp or discolor. It is not brittle like composition. The surface is highly polished. The engraving is filled with white enamel and the 100 division scale reads from right to left for clockwise rotation.

The knob is molded bakelite $1\frac{3}{8}$ " diameter. The bushing is drilled for $\frac{3}{16}$ " or $\frac{1}{4}$ " shaft, and the set screw passes through both knob and bushing. The construction insures an absolutely true running dial.

No. 101—Remler 3" Bakelite Dial only \$0.75
No. 100—Remler 3" Bakelite Dial with knob and bushing, specify $\frac{3}{16}$ " or $\frac{1}{4}$ " shaft 1.00

No. 93

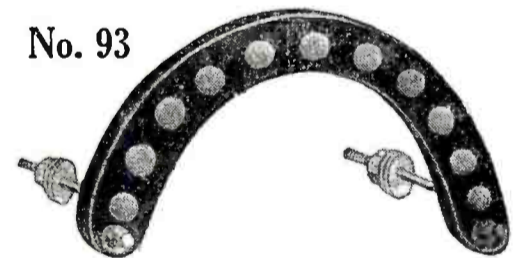

Patent Applied For

REMLER A-BATTERY POTENTIOMETER

THE plate voltage of any detector tube must be carefully adjusted for maximum sensitiveness and signal audibility. Potentiometer control provides close adjustment with ease of operation. This new Remler Unit with metal inserts provides positive definite electrical contact and eliminates the uncertainty of carbon to graphite contact. This Remler Unit is not brittle and is connected across the A-Battery to control the plate potential over a six volt range by half-volt steps. Circuit diagram furnished with each unit.

No. 93—Remler A-Battery Potentiometer Unit only, with studs for panel mounting \$0.75
No. 94—Remler Rotary Lever Switch for use with No. 93 Unit45

Remler Radio Apparatus

THE remarkably high quality of every Remler item is not accidental, but the final result of years of research work, painstaking study and perfection of manufacturing processes. The uniformly handsome appearance of the Remler line—the accuracy and precision of each individual item—the truly wonderful results that are obtained from the use of this "Apparatus That Radiates Quality"—these facts have made REMLER the choice of those who really know radio apparatus.

DEALERS: There is a very profitable proposition for you on Remler Apparatus. Write for full particulars.

REMLER RADIO MANUFACTURING COMPANY

248 FIRST STREET
San Francisco, Cal.

E. T. CUNNINGHAM
General Manager

154 W. LAKE STREET
Chicago, Ill.

Truth Courts the Light But Error Shuns It



DEFINITION
The practice of Chiropractic consists of the adjustment, with the hands, of the movable segments of the spinal column to normal position for the purpose of releasing the prisoned impulse

Ask Your
Chiropractor
for
"The Last Word"

The chiropractor tells you his message in English because he wants you to understand. He doesn't camouflage his ignorance with Latin.

Truth is the same always and everywhere, and because the practice of Chiropractic is based upon truth it is a universally efficient method.

The laws of nature are the same yesterday, today, and forever; and because Chiropractic is based upon natural law, it does not change its explanation of disease with the seasons.

Since Chiropractic depends upon the operation of natural law for its results, chiropractors do not require faith or credulity of their patients.

Chiropractic is a demonstrable science. It is the most efficient method of getting the sick well and any chiropractor will gladly show you just what he does, and tell you why he does it.

Write for information regarding Chiropractors or Schools to the
UNIVERSAL CHIROPRACTORS ASSOCIATION, DAVENPORT, IOWA

ATWATER KENT RADIO APPARATUS

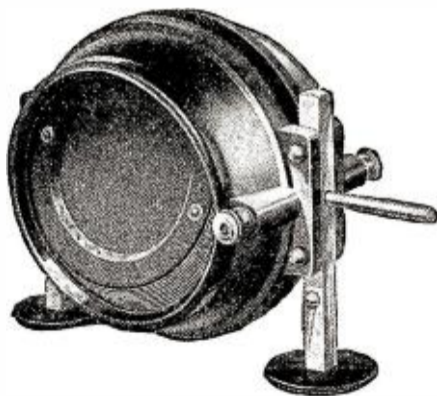

VARIOMETER

VARIOMETERS
TRANSFORMERS
VARIOCOUPERS
RHEOSTATS

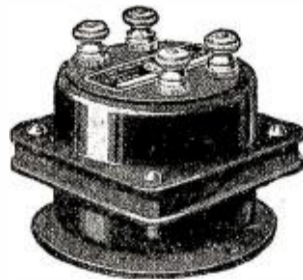

TRANSFORMER

DESIGNED in the Atwater Kent research laboratories and manufactured complete in this plant from moulding of the condensite forms to winding of the fine wire coils—an assurance of quality.

Highest grade materials are used in construction thruout each unit and a very complete final test is a guarantee of 100% performance.

Correspondence Solicited

ATWATER KENT MANUFACTURING COMPANY
4943 Stenton Avenue RADIO DEPARTMENT Philadelphia, Pa.

Should it be desired to mount the instrument on a panel with other instruments it may be built directly upon the panel. On account of its small size, such a condenser is ideal as a grid condenser on a vacuum tube control panel. If it is to be put to such use, the mica washer may be eliminated and one made of paraffined paper used instead, as the mica dielectric is used only in order to obtain a capacity up to .001 microfarads. Fig. 1 is a top view of the completed instrument.

Practical Information on Reception of Radio Signals

(Continued from page 262)

battery current which flows from the plate to the filament. The grid is placed between the plate and filament and is actuated by the energy of the incoming signals in such a way as to control the flow of current in the plate circuit and thus produce vibrations in the telephone receivers.

The characteristics of a detector tube are such that by using a condenser in series with the grid, as at X, the high frequency impulses of the received signals tend to produce and accumulate upon the grid a voltage of negative polarity which causes a decrease in the plate current. In order for the grid to be ready to respond to each succeeding train of electrical vibrations it must rapidly be restored to the filament potential by the leakage of the negative charge upon it.

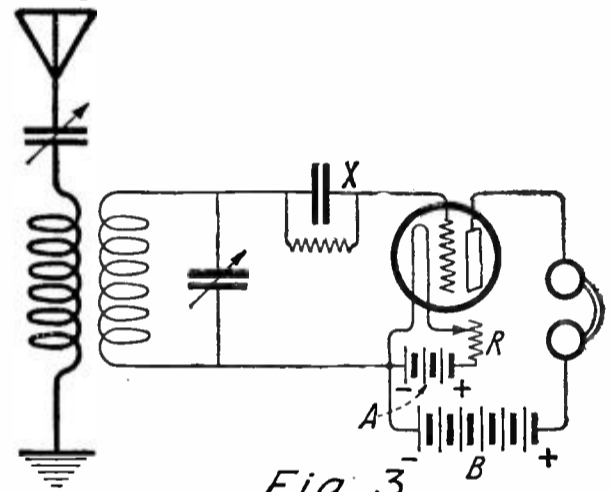

Diagram of a Vacuum Tube Used as a Detector.

With some tubes there is sufficient leakage in the tubes themselves, and sometimes a condenser has imperfect insulation which allows the charge to escape, but where all the insulation is practically perfect it is necessary to place a high resistance in parallel with the grid condenser. This resistance should be of the order of half a million to one million ohms, while the grid condenser should have a capacity of about 0.00025 microfarad. The best values to be employed vary somewhat with different tubes. If the resistance is too high, leakage will take place slowly, causing a sputtering sound in the receivers, while too low a resistance will cause too rapid leakage and a weak signal, because the negative grid potential cannot accumulate to full value in the direction of each wave train. Receiving tubes are usually designed so that they give best operation when the low side of the grid circuit is connected to the negative potential side of the filament.

Filaments of standard receiving tubes are provided to operate on four to five volts at the terminals. This requires a battery of about six volts in order to provide for losses in the leads to the set and filament control by means of the variable resistance R. Tubes now in common use require about one ampere filament current at five volts. To provide for the extra volt of the battery the controlling resistance would therefore need to be about one ohm actually in the circuit.

It is very important that the polarity of the "B" battery should be as shown, with the positive side towards the plate. If this polarity is reversed, no plate current can flow and the tube will be inoperative. With

EISEMANN



RADIO HEAD PHONES

\$8⁰⁰
Complete

Specifications

- Receiver Case—Aluminum.
- Coils—Wound with highest grade enamelled insulated copper wire.
- Resistance—2200 ohms.
- Ear Caps—Rubber composition.
- Magnet—High percentage Tungsten Steel—permanent.
- Diaphragm—Rust-proof.
- Cord—Six foot.
- Head Band—Approved spring wire—self-adjusting, sliding rod type.

FAITHFULLY reproduces all broadcasted musical and spoken sounds. This set is unequalled for tonal quality and perfect balance of the receiver. Designed on sound scientific principles by an engineering organization of long experi-

ence. Made to give you the greatest possible enjoyment from your receiving outfit.

All products manufactured by the Eisemann Magneto Corporation are *guaranteed* to be mechanically and electrically correct.

*Order from your Dealer or direct.
Jobbers and Dealers write for discounts.*

EISEMANN MAGNETO CORPORATION

Radio Division

32-33rd Street, Brooklyn, N. Y.

DETROIT

CHICAGO

See September issue for interesting announcement of other Eisemann Radio Equipment

To Hear Radio Music Perfectly



Matched-Tone is a trademark registered in the U. S. Patent Office.

The fact that Brandes *Matched-Tone* headsets are part of the standard equipment of the receivers supplied by the leading radio manufacturers speaks for itself. Unless the purchaser of a receiver hears well, he cannot enjoy broadcasted music to the utmost.

If your receiver is not equipped with a Brandes *Matched-Tone* headset you can buy one from your dealer, with the understanding that unless you obtain the results expected of it, he will refund your money after ten days' trial.

C. BRANDES, INC.

Wireless Headset Specialists

237 LAFAYETTE STREET

NEW YORK, N. Y.

"Black Beauty" Dial and Knob

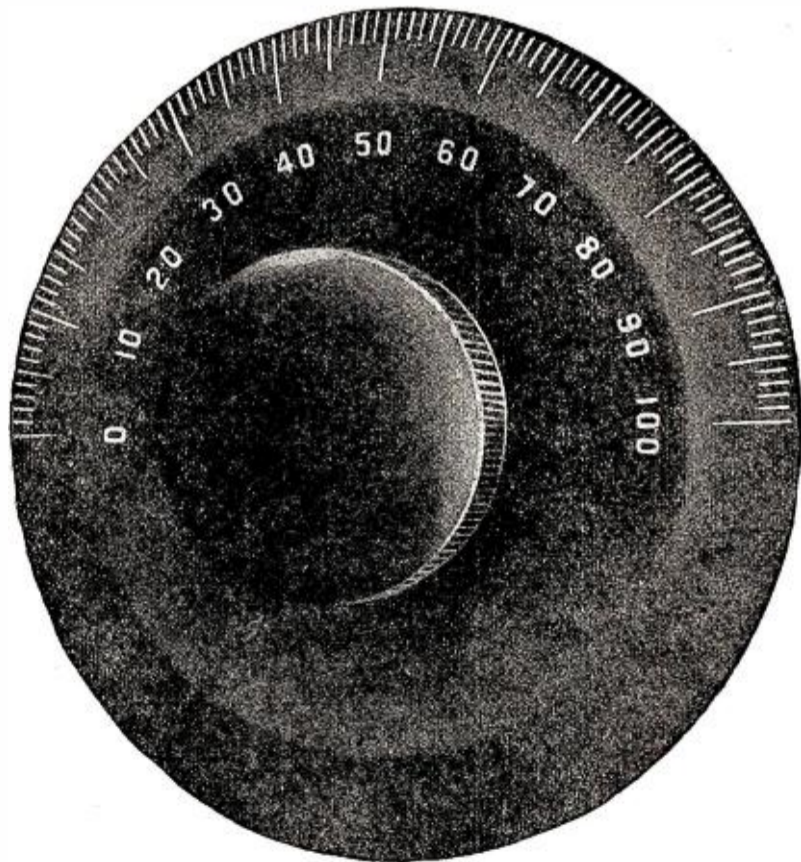

Our No. 1373—Made in 2", 3", 3 1/4", 3 3/8", 4", with 3/16" or 1/4" shaft. They're all guaranteed not to warp, have a permanent jet black surface with genuine silver plated calibrations and figures engraved thereon. Sold without knobs to manufacturers if necessary.

Write for circular on Elimination of Body Capacity and difficulty in tuning

Mr. Manufacturer:

Get ahead of your competitors by using No. 1373 Dial for enhanced appearance, moderate price and quick deliveries. Write for dealers, jobbers or manufacturers' prices.

ETCHED PRODUCTS CORP.

Detroit
Milwaukee
Des Moines
Seattle

MFGS. NAME-PLATES, DIALS, SCALES, ETC.

Long Island City, N. Y.

Tel. Hunters Point 6230-6231

Newark
Boston
Chicago
Cleveland

highly evacuated tubes the "B" battery voltage is not critical and may be 22 to 45 volts, preferably the latter. However, with gas filled tubes, which are more sensitive detectors, it is necessary to have a "B" battery voltage of about the right value, generally 18 to 22 volts. This adjustment may be obtained by tapping to individual cells of the battery or by the potentiometer arrangement shown in Fig. 4. The voltage applied to the plate is the voltage between the negative side of the filament and the positive side of the "B" or plate battery. When the negative of the plate battery is connected to the negative of the filament battery, then the plate voltage will be the voltage of the plate battery alone, while if the negative plate battery is connected to the positive side of the filament battery, the total plate voltage will be the sum of the "A" and "B" batteries together. Thus by adjusting the potentiometer, any desired amount of the "A" battery voltage may be added to the voltage of the "B" battery to give the proper value for best detection.

Referring again to Fig. 2, it will be seen that there is a third inductance coil, inserted in the plate circuit and coupled to the coil in the grid circuit. The purpose of this additional coil is to bring about amplification within the detector tube itself by a process known as regeneration. Since perfect rectification does not take place in the tube there is a certain amount of high frequency current flowing in the plate circuit. By coupling

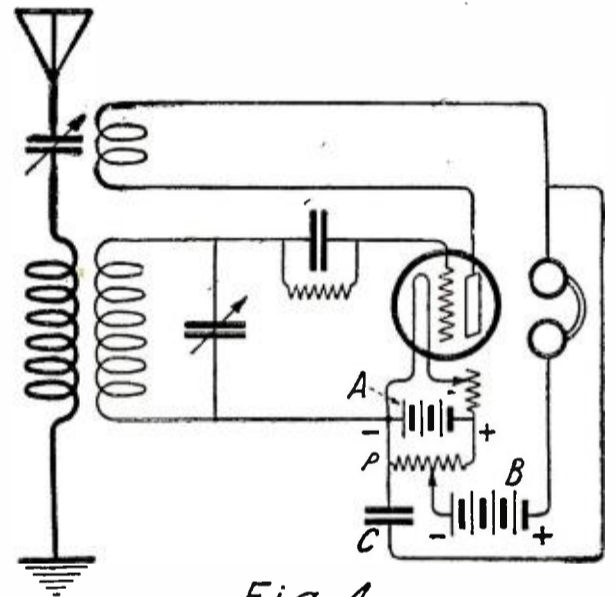

Hook-Up of a Standard Feed Back Circuit.

the plate circuit back to the grid some of this high frequency is again impressed upon the grid circuit and is amplified through the tube. The plate coil, commonly called the "tickler" coil, must be coupled back with the correct polarity and by adjusting this coupling to the proper intensity, the signal strength will be greatly increased. If too much coupling is used the adjustment becomes very critical and the tube will finally oscillate, thus becoming a generator of high frequency which is radiated on the receiving antenna. This radiation will then be picked up by other receiving sets in the vicinity and cause great disturbance to the reception of distant signals. Regeneration should therefore be carefully controlled so that the receiving set does not oscillate, for if several sets in a given locality are all trying to receive on the same wavelength, and are all radiating a small amount of energy, they will interfere with each other and none of them will be able to get any satisfactory results.

The condenser, C, shown in shunt with the telephone receivers and plate battery acts as a by-pass for radio frequencies in the plate circuit, since the telephone windings offer too high an impedance to allow such frequencies to pass freely. The required capacity is not critical, but should have a value between 0.001 and 0.005 microfarad.

There are various other ways of obtaining regeneration, such as capacity coupling



NOW that the problems of Radio broadcasting have been solved, the real pleasure and usefulness of wireless telephony is dependent on possessing the only perfected loud speaker—the Magnavox Radio.

Your receiving set only brings the message, while Magnavox Radio tells it clearly and in full volume to all within reach of its voice.

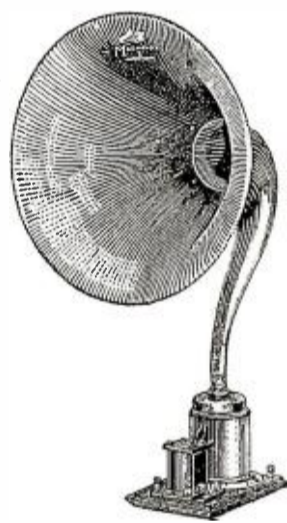

R-2 Magnavox Radio with 18-inch horn

This instrument is constructed on the electro-dynamic principle ("the reproducer with the movable coil") making it a most efficient converter of electrical energy into sound waves.

Type R-2 has very great amplifying power, yet requires only .6 of an ampere for the field.

R-2 serves the requirements of professional use for large audiences, dance halls, etc.

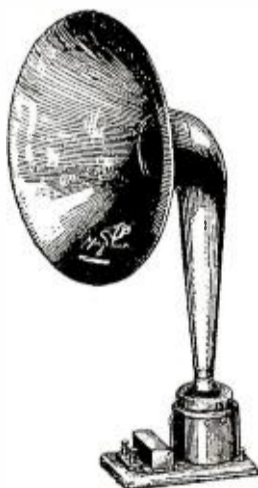

R-3 Magnavox Radio with 14-inch horn

Same in principle and construction throughout as Type R-2, but possessing slightly less amplifying power. Requires one ampere field current from your filament battery.

R-3 Magnavox Radio is ideal for use in homes, offices, amateur stations, etc.

With either type Magnavox Radio the hookup is simple and no extras or adjustments are required.

Attached to any commercial receiving set, the Magnavox Radio makes it possible for you to hear all that is in the air as if it were being played by your phonograph.

Whatever your previous experience (if any) with Radio has been, a new world of enjoyment awaits you in the service of the Magnavox Radio.



Magnavox Power Amplifier—Model C

The Magnavox Power Amplifiers insure getting the largest possible power input for your Magnavox Radio. They can be used with any "B" battery voltage the power tube may require for best amplification.

Switching from stage to stage is made easy by master switches, as illustrated. 2 and 3-stage.

More wonderful day by day grows the range of entertainment, recreation and information supplied by central broadcasting stations in all parts of the country.

It is the development of Magnavox Radio which has made these wireless programs fully enjoyable—removing the restrictions and limitations imposed by the telephone headset.

**Full Information—
Send For It**

Every radio user (present or prospective) will be interested in reading this new folder on the Magnavox Radio.

It contains full information about this wonderful reproducer, with illustration, description and list price of the various instruments.

Even if you do not now own a receiving set you should learn how the possibilities of wireless telephony have been revolutionized by the development of Magnavox Radio.



On receipt of request we shall be pleased to send you free copy by return mail.

THE MAGNAVOX COMPANY

Home Office and Factory: Oakland, California

New York Office: 370 Seventh Avenue

TRADE **ESCO** MARK

**HIGH VOLTAGE MOTOR-GENERATORS
STAND PRE-EMINENT IN WIRELESS FIELD**

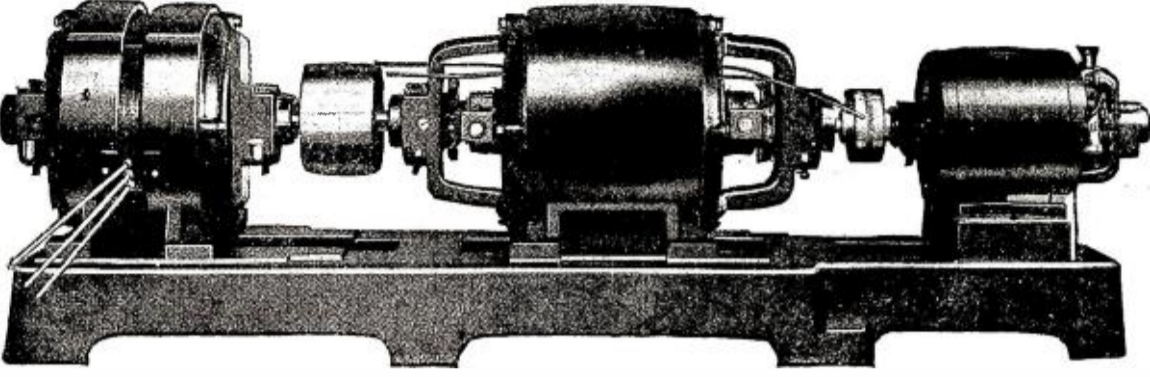

Used by Leading Educational Institutions, U.S. Gov't Research Laboratories, Newspapers, Department Stores, Etc.

ESCO

Manufactures Over 200 Different Combinations of Windings for Wireless and Develops Special Apparatus for Special Requirements. Send Us Your Problems

Write for Bulletin No. 237—Complete Information

**MOTORS—DYNAMOTORS—GENERATORS—MOTOR-GENERATORS
SOLD BY PRINCIPAL DEALERS EVERYWHERE**

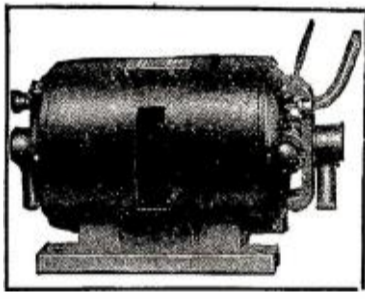

ELECTRIC SPECIALTY CO.

211 SOUTH STREET
STAMFORD CONN., U. S. A.

**“ILLINOIS” THE RELIABLE
MADE RIGHT - STAYS RIGHT**



STYLE NO. 1



STYLE NO. 2



VERNIER

Three Styles: No. 1, Panel; No. 2, Open Type as shown; No. 3, Fully Encased. Anti Profiteer. Less than pre-war prices. Fully assembled and tested.

	Style No. 1	No. 2	No. 3
67 Plates,	\$7.00	\$8.00	\$8.50
43 "	3.50	4.50	4.75
23 "	2.75	3.75	4.00
13 "	2.25	3.25	3.50

Money back if not satisfied. Just return condenser within 10 days by insured Parcel Post.

Options: — With Style No. 1—instead of Scale and Pointer, a 3-inch Metal Dial at 50 cents extra, or a 3-inch Bakelite Dial at \$1.00 extra. Large Knobs. Both excellent values. Or we will, if desired, supply the Condenser with smooth 3-16 inch center staff, without Scale, Knob and Pointer, at 15 cents off the list to those who prefer to supply their own dial.

Vernier with single movable plate applied to 13, 23 or 43 plate condenser, \$3.00 extra.

We allow no discounts except 5 percent on orders of 6 or more.

SENT PREPAID ON RECEIPT OF PRICE

Except: Pacific States, Alaska, Hawaii, Philippines and Canal Zone, add 10c. Canada add 25c. Foreign Orders other than Canada not solicited.

G. F. JOHNSON, 625 Black Ave., Springfield, Ill.

between the grid and plate, or by tuning the plate circuit, all of which produce substantially the same results, greatly increasing the signal strength. Regeneration is therefore a valuable asset in obtaining strong signals, but its use should not be abused in broadcast receiving by allowing the set to radiate, thus causing misery to all nearby listeners.

THE AMPLIFIER

We have studied some of the main points which must be kept in mind in order to secure efficient operation of a detector circuit, and now that we have learned how to make the signals audible our next step will be to find out how to increase the strength of these signals. This is desirable in order to make weak signals loud enough to be understood distinctly and in some cases can be carried to a point where the signal strength will operate loud-speaking devices so that it is not necessary to use headphones.

In studying the vacuum tube detector we learned that it acts as a relay in which the amount of current flowing through it from a local battery is controlled by the weak impulses of incoming signals. By the use of one or more additional vacuum tubes the detected signal can be greatly increased in volume. Each tube has a certain amount of voltage impressed upon its grid and input circuit, and because of its relay action this voltage is amplified and passed along to the next tube or to the telephone receivers.

The problem, then, is to provide a means of coupling the output of one tube to the input of the next, to obtain as much amplification as possible and at the same time to

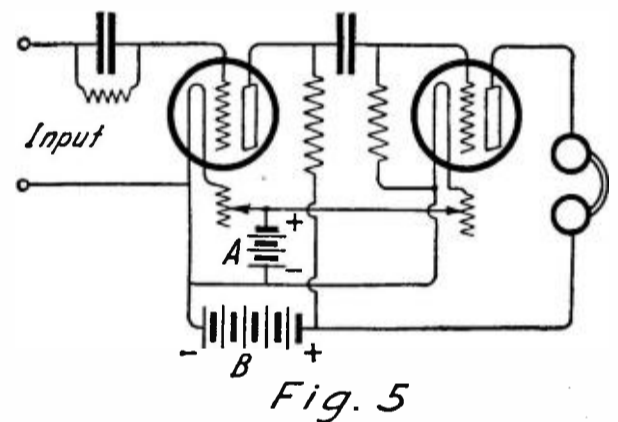

Diagram of a Vacuum Tube Detector and One-Stage Resistance Coupled Amplifier.

preserve the original quality of the signal without distortion. Tube coupling can be accomplished by means of various combinations of resistances, reactances, condensers or transformers. Resistance coupling gives the least amplification but preserves the best quality of reproduction, while transformer coupling produces the most amplification and is liable to cause more or less distortion to the signal in doing so.

Fig. 5 shows a method of coupling from a detector to an amplifier tube by means of resistances and a condenser. The plate resistance should be equal to or a few times greater than the internal plate circuit resistance of the tube. For standard tubes this would be 25,000 to 200,000 ohms. The grid resistance should be one or two megohms, and the coupling condenser about .005 microfarad. Such an amplifier will increase the signal audibility about five times per stage and will preserve good quality in the speech and music of telephone signals. It is quite important that all contacts and connections be as nearly perfect as possible in order to eliminate amplifier noises.

For reactance coupling, the plate resistance or both the plate and grid resistances, should be replaced by choke coils having impedances at audio frequencies equal to the resistances replaced. Reactance coupling will give somewhat greater amplification than plain resistances since the required voltage drop across them can be obtained with less energy lost in the resistance of the circuit.

Fig. 6 shows the typical connections for a detector tube and one stage of transformer

Ask to See This New Radio "B" Battery

Ask also to see the Willard All-Rubber Radio "A" Battery—a 6-volt battery built especially for Radio reception.



Ask your dealer or your nearest Willard Service Station to show you this specially designed 24-volt rechargeable Radio "B" Battery. Note the leak-proof glass jars—hard rubber screw-on covers—special Radio "B" plates—Threaded Rubber Insulation.

These features considered, it is not surprising that the Willard Radio "B" Battery has such a *remarkable ability to hold its voltage*, or that it is so noise-free and trouble-proof.

WILLARD STORAGE BATTERY COMPANY, CLEVELAND, OHIO
Made in Canada by the Willard Storage Battery Company of Canada, Limited, Toronto, Ontario

Willard

THREADED
RUBBER
BATTERY

**SERVICE IS
P.W.S.
SLOGAN**

Since 1911 the constant efforts of our personnel to render the highest possible service to manufacturers and dealers has placed us among the leaders in the Radio field.

Every article sold by us is backed by our approval, which marks it as a standard product of merit.



We cordially invite you to avail yourself of this service, whether your business is large or small.

We will be pleased to correspond with manufacturers desiring distribution in our territory

Philadelphia Wireless Sales Corp.
1533 PINE STREET PHILADELPHIA, PA.



Thousands of Unfilled Orders
for the
TELMACOPHONE
What's the Reason?



Much to our regret we have been unable to fill all orders for the Telmacophone promptly. The demand has been far beyond our expectations. When we first advertised the Telmacophone we felt confident that it was the greatest value ever offered.

Our own confidence has been sustained by the public, which has taxed our manufacturing facilities to the limit.

All unfilled orders will be taken care of just as soon as possible. To those who have not yet ordered the Telmacophone we want to assure you that it is well worth waiting for. Do not be satisfied with an inferior substitute.
Price, Complete, \$20.00 Fully Guaranteed

**RADIO DIVISION
TELEPHONE MAINTENANCE CO.**

Note new address
Dept. B, CHICAGO, ILL.

DEALERS! We are distributors for nearly all standard lines. Full discounts on the Telmacophone. Write for proposition on our complete line.
20 S. WELLS STREET,

coupled amplification. In arranging such a circuit it is important that the various parts be so placed that the wiring will be as short and direct as possible. This is especially desirable where two or three stages of amplification are to be used since back coupling from the output to the input of the amplifier will cause it to oscillate or "howl" so that it is useless for signal reproduction. Even if it does not actually oscillate, a little back coupling will cause enough regeneration to bring the tubes near the oscillating point, and this condition will make the signals hollow sounding or "ringy."

There are a good many types of amplifying transformers on the market, some with air cores, but most of them with iron cores, since the latter construction requires considerably less turns of winding and can be made to occupy less space. Naturally the various makes of transformers differ in their amplifying characteristics and most of them amplify much better at some particular tone than they do at other tones higher or lower. For this reason transformer coupling, when used for the reception of radio telephone music, is liable to change the proportion of the sound intensities and destroy their original pleasing qualities.

Referring to Fig. 6, it will be seen that the filament rheostat is in the negative side of the filament lead, and that the low side of the transformer is connected to the negative side of the battery. Since the reference point of the various tube voltages is the negative side of the filament, this arrangement will place a negative potential on the grid of the amplifier tube, amounting to the voltage drop of the rheostat, and this will usually give the greatest amplification. The characteristics of amplifier tubes are such that about one volt negative voltage on the grid is desirable. A positive grid voltage will cut down the amplification and a connection directly to the positive side of the filament may even make the tube inoperative or reduce the signal instead of increasing it.

The Sensitivity and Precision of the Electrostatic Transmitter for Measuring Sound Intensities

(Continued from page 238)

sitivity was observable. It is thus reasonable to assume that under ordinary conditions the sensitivity will not change appreciably during the course of several years.

EFFECT OF TEMPERATURE AND PRESSURE ON SENSITIVITY

When a rigid plate was used in place of the flexible rubber diaphragm, C, and equalization of the static pressure on the two sides of the diaphragm thereby prevented, measurements with the piston-phone and electrostatic voltmeter showed that the sensitivity of the transmitter changed about 2 per cent. per degree Centigrade at 200 cycles. With the rubber diaphragm, however, within the temperature range of 20 to 40 degrees C. the total change in sensitivity was less than 2 per cent., which is negligible for all practical purposes. The principal reason for this small temperature coefficient lies in the fact that the instrument is constructed almost entirely of the same material. The clamping rings and the diaphragm have nearly the same temperature coefficient of expansion, so that any change in temperature will produce but little change in the tension of the diaphragm. The diaphragm, although thin, cannot assume a temperature very different from that of the frame, for it is separated by such a small distance from the back plate that heat can flow from one to the other nearly as readily as if they were in contact.

*Everything
in
Insulation*

"SPAGHETTI"

PAPERS, WAXES, COMPOUNDS, PAPER TUBES, VARNISHES FOR IMPREGNATING AND FINISHING, ETC., ETC.

ESTABLISHED 1889

MITCHELL-RAND MFG. CO., 21 VESEY STREET, NEW YORK

Picked Up Detroit— Denver—Pittsburgh—Newark —With No Amplification

CHICAGO, ILL.

"I THOUGHT that you might be interested in hearing of the results I obtained on Monday night of this week with your H. R. Receiver and absolutely no amplification. An interior antenna consisting of about a hundred feet of No. 14 rubber covered wire was used.

"My home is at Winnetka, about eighteen miles north of Chicago, on the lake. After picking up the Chicago station I next listened to a concert in Detroit, then a concert at Pittsburgh, then a concert and entertainment at Newark, and next the last part of the Denver, Colo., program. After that I picked up two other stations that I could not identify, but as it was after ten o'clock here I figured that they must be western stations."

CHARLES A. NASH

THIS is a typical experience with Clapp-Eastham equipment—we receive such letters daily. The wide range of this H.R. Set and the sharp clearness with which messages and music come in surprise experienced radio men and absolutely amaze the inexperienced.

Simple to operate—neat in appearance—reasonable in price—this set appeals to radio enthusiasts of all types. And the fact that it is made in a plant that has specialized exclusively in radio for more than 14 years guarantees careful workmanship.

If your dealer, because of the unprecedented demand, cannot show you this Clapp-Eastham Set, or cannot supply this set from his jobber, write us. Complete new Radio Catalog 6c.

CLAPP-EASTHAM CO.,
139 Main Street, Cambridge, Mass.
Oldest and Largest Exclusive Makers of Radio Equipment

SPECIFICATIONS

Cabinet: Solid mahogany, dull finish.
Panel: Condensite, dull finish, machine engraved, white lettering.
Dials: Indestructible metal, black with white lettering.
Condenser: Balanced type, built as a Vernier; 2 rotary, 3 stationary plates.
Antenna Inductance: Wound on formica tube.
Plate Inductance: Wound on molded ball.
Binding Parts: Black rubber covered.
Switch: Fan blade.
Rheostat: Clapp-Eastham type H 400.
Circuit: Single circuit regenerative.
Price: \$40.

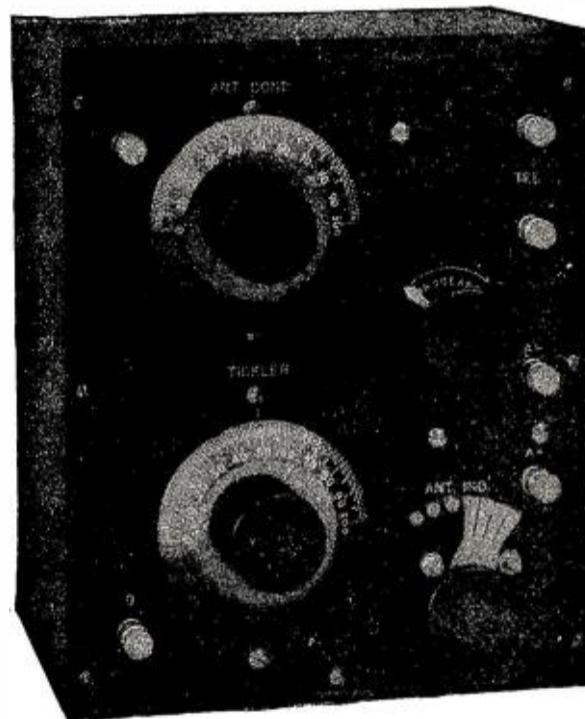

Regenerates wave lengths of 180 to 825 meters perfectly.

CLAPP-EASTHAM

TYPE HR

Regenerative Receiving Set

(Licensed under Armstrong U. S. patent No. 1,113,149)

Puts You in Touch With the World

Price, Prepaid
\$20⁰⁰

Including 22½ volt "B" Battery, 150 feet aerial and insulators.

Price, without these accessories **\$18⁰⁰**

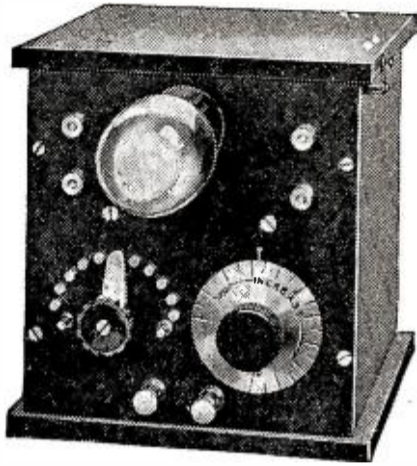

DEALERS:

Write or wire at once for our attractive proposition. You will be proud to handle the Miraco equipment. Sells readily and keeps your customers "sold" by giving lasting satisfaction.

The Midwest Radio Company
Cincinnati, Ohio

Miraco Vacuum Tube Radio Receiver

The Miraco Vacuum Tube Radio Receiver will put you in touch with the world. You can enjoy concerts, market and weather reports, speeches and sermons while seated by the camp fire or on the porch of your cottage several hundred miles away from the powerful broadcasting stations.

The Miraco Vacuum Tube Receiver does away with all troublesome crystal detector adjustments. It is carefully constructed in our own factory and is dependable, efficient and up-to-date in every respect. It is handsomely finished and extremely durable. Perfect reception on wave lengths from 150 to 600 can be obtained.

All you need to complete your Miraco outfit are 'phones, vacuum tube and a 6-volt storage battery or dry cells.

If there were no displacement of the rubber diaphragm a change in temperature of 20° C. would produce a difference in pressure on the two sides of the diaphragm equal to 7 per cent. of one atmosphere. It follows, therefore, that a change in atmospheric pressure as great as this will not change the sensitivity of the transmitter by an appreciable amount.

COMPARATIVE SENSITIVITY OF THE TRANSMITTER

The mean value of the sensitivity of the transmitter given above is approximately 0.35 millivolt per dyne. A more comprehensible idea of this sensitivity may be obtained from the fact that the male voice in ordinary conversation exerts a pressure of about 10 dynes per sq. cm. at a distance of 3 cm. from the mouth of the speaker. With a three-stage amplifier, thermocoupler and a galvanometer pressures as low as 0.01 dyne per sq. cm. may be measured. If the tone is produced by some electrical device such as a telephone receiver and the source of current is supplied by an oscillator, an a.c. potentiometer may be used. In this case pressures may be measured which are barely perceptible to the ear.—*Abstract from the Physical Review.*

A Hill Billy's Radio

(Continued from page 249)

mountain peaks, but they were so close together, and so high, that I could only use a 25' aerial, but I had to use a 5280' lead in, coming vertically from the aerial to my window. The logarithmic decrement of this aerial was 10.679 Dynes and I thought this was a good sign. The wave-length of the aerial was so low that I had to use a whole hive of honeycomb coils to bring it up to par.

Very probably my method of measuring the wave lengths of the incoming messages will be of interest. I lower the aerial, while it is receiving messages, and hook a steel surveyor's tape over a hook glued on the cast iron insulating spreaders. The tape is graduated in both amperes and ohms. I can measure the waves with no trouble. The fundamental wave-length of my aerial is four kilowatts, and my set will receive messages from one *chronometer* to 19 *light years* in length. As you probably guessed, time signals come in on both of these wave-lengths.

With my set I operate even to the third and fourth regeneration. On my former aerial there was not much input current, but now there is enough juice to flood the magnetic fields.

Speaking of time signals, it reminds me that they come here exactly an hour early each day. Some one tried to explain it, but I could not understand. I think it is because they use the common one cycle wave. I plan to use a *bi-cycle* wave, which would travel faster than a walk. I visited one of the time signal sending stations last fall. The local jeweler sets his clock by the time signals, and the telegrapher sets his watch by the jeweler's clock, and the watch is the standard for sending out the time signals.

I must not forget my sending station. I use only the spark set. I employ the conventional Colpitts circuit, with Heising Circuit modulation. I have placed electrodes of formica on the rotor of the phonograph, and use it as a rotary spark gap. I send C. W. and telephone with my spark set. Owing to the fact that the turntable, or rotor, runs by spring power, the speed rotation varies from zero to infinity, thus aiding the reception of signals. I have found that the use of condensers, coils and oscillation transformers is unnecessary with my set, and with one kilowatt input I radiate fifty-six amperes. Owing to the high temperature—I

PINK-A-TONE

DETECTOR OF THE AIR

MANUFACTURED BY
PINKERTON ELECTRIC
EQUIPMENT COMPANY



GENERAL SALES AGENT
NATIONAL SERVICE COMPANY

The Crystal Radio Receiver with
the Seven Points of Superiority
that has already achieved its
success in New York City.

10,000 Sets Sold in Six Weeks

Executive Office 1834 Broadway New York City



Radio Frequency Transformers

Type RT-1, for the amateur and
broadcasting range, 175-500 meters.
(Patent Pending.)

\$6.00

Will work on all tubes.
"The only completely shielded iron core
R. F. transformer"

RASLA SALES CORPORATION
10 EAST 43rd STREET NEW YORK
National Distributors for Radio Service Laboratories, Inc.



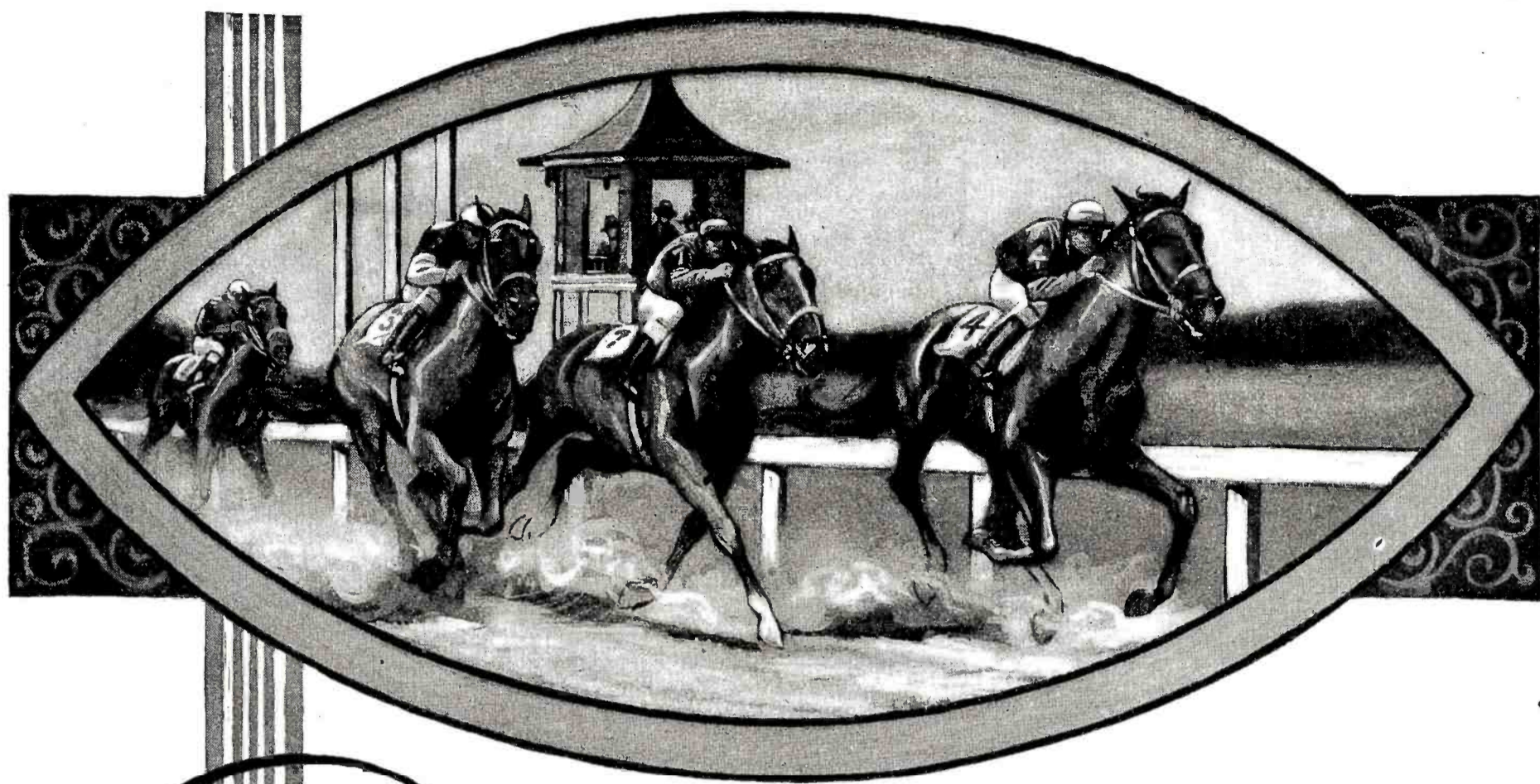

Here off!!!



OFF the beaten path and on the trail to a worth-while goal. "Thoroughbred Apparatus" has been constantly winning new friends and has hung up some enviable records as a quality leader in radio apparatus.

Our goal is *unwavering superiority*, and we intend to come under the wire *with* "Thoroughbred Apparatus" in the lead of the radio field.

On June 1st we moved into our new factory. Now, with greatly increased facilities, we are prepared to handle your orders as they come. Write for our interesting offer to reliable dealers.

"Thoroughbred Apparatus" consists of: Moulded Variometers, Vario-couplers, "Read 'em" Binding Posts, 17 styles, Amplifier Panels, Detector Panels, Variable Condensers, Fixed Condensers, Binding Posts, Contact Points and Stop Pins, Switch Levers, Dials, Single Sockets, Rheostats, Crystal Detectors.

THE MARSHALL-GERKEN CO.

Jackson and N. 12th St.

Toledo, Ohio

Thoroughbred Apparatus

EKKO
Fits Any
Standard
Phonograph



EKKO
Fits Any
Radio
Headphone

Make a Loud Speaker of Your Phonograph

Ekko is a simple mechanical device that connects your headphones with the tone arm of your phonograph, and transmits Concerts and Programs through the sound box.

Ekko is the best Loud Speaker you can use. By utilizing the scientific design and fine workmanship of the phonograph sound box, Ekko produces a clear, pure tone unsurpassed by the most expensive amplifiers.

If your dealer does not yet carry Ekko, send \$3.00 and we will mail you one immediately, post paid. Money back if you are not satisfied. Mention the make of your phonograph in ordering.

THE EKKO COMPANY, 911 Harris Trust Bldg., Chicago

REX

TURNEY
Unexcelled Radio Products

Voxola 7½x9x5½ -	\$30.00
Monoplex 11x11x4½	40.00
Multiplex 11x16½x4½	65.00
Head Set (Non-Fatigue 8-Ounce)	6.50
Socket - - - - -	.60
Two-Way Plug - - -	1.20
Plex 4½x5x4½ - - -	5.50
Duplex 16½x4x6 - -	15.00
Vitaphone 8½x11x4½	20.00
Amplifier 8½x11x4½	20.00

Send for descriptive catalog of complete Turney Radio Products

Rex Radio Sales Corporation

National Distributors of

TURNEY'S Unexcelled Radio Products

GET on the band-wagon for prompt delivery. Ask about the TURNEY Spider Web Coil and Non-Fatigue 8-Ounce Head Set.

Liberal Discounts to Jobbers and Dealers

REX RADIO SALES CORPORATION

Distributors of "Everything Radio"

1452 BROADWAY Telephone, Bryant 6456 NEW YORK

IF YOU CAN'T READ

Dots and dashes you are missing the most important and interesting part of radio receiving. Continental Code Chart as used by author in teaching, is the surest, quickest and most reliable way of learning. \$1.00, no stamps.

E. A. NIELSEN Box 67, Waverley, 79, Mass.



use a hot wire ammeter—I was troubled for a while with a *Corona*, but now I use a rebuilt Underwood, purchased on the installment plan.

I will tell of a few of the improvements I have made in the reception of signals. I found that at times the signals were so weak that they were almost illegible. I constructed an electromagnet and put it in series with the receiver, which would not sound, due to the weakness of the currents. I purchased a large drum and drumsticks of laminated iron, and hinged them so that the pull of the electromagnet would cause the drumsticks to strike the drum, and thus reproduce the signals. I had no more trouble with weak signals, and this would also receive music to perfection.

The device which I consider my most valuable contribution to radio, however, is what I call a static trap. The theory follows, although patent litigation does not permit me to divulge all particulars. I have a waterproof basket arranged on my operating table, and when the static waves come over it, they fall in. There is no trouble in receiving music, however, for the audio frequency voice waves are superimposed on a carrier wave. This carrier wave carries the music over the basket, without falling into the set. I save the static waves, which are made of lightning and X-rays and use them for medical purposes. It is generally known that after a person is exposed to lightning, he is no longer subject to the ills which beset human flesh.

The Electron Theory Simplified

(Continued from page 240)

form a molecule of lead sulphate (PbSO₄).

It is now generally accepted that the atoms of matter are minute systems of *electrons*, which are united charges of electricity of negative polarity, either revolving about a central positive nucleus or surrounded by a sphere of positive electricity. These electrons are considered as being the smallest quantities or charges of negative electricity that ever were found to appear in electrolysis. It is estimated that the diameter of an electron is on the order of a million millionth of a centimeter. Or in other words, an electron is about 60,000 times smaller in volume than the hydrogen atom. Is it any wonder that its (*the electron's*) existence is difficult to comprehend? The electronic system may be thought of as similar to our solar system. Thus the movement of the electrons in definite orbits about the central positive nucleus resembles that of the different planets which revolve about the sun located, as it is, at the center of their orbits. There is this important difference, however. The various planets are not alike in size or weight, whereas all the electrons are identical. The difference between the atoms of the various substances is merely in the number and arrangement of the electrons constituting them. Under normal conditions the positive charge of the nucleus about which the electrons move is equal to the sum of the negative charges of the electrons. Hence, the amounts of positive and negative electricity neutralize one another and none of the common manifestations of an electrical current are observed.

If one or more of the electrons become detached from an atom of matter, the latter is left with an excess of positive electricity. The atom is then said to become a *positive ion*. Likewise, if one or more electrons in excess of the normal complement of an atom are added to the latter, a surplus of negative electricity will result

(Continued on page 305)

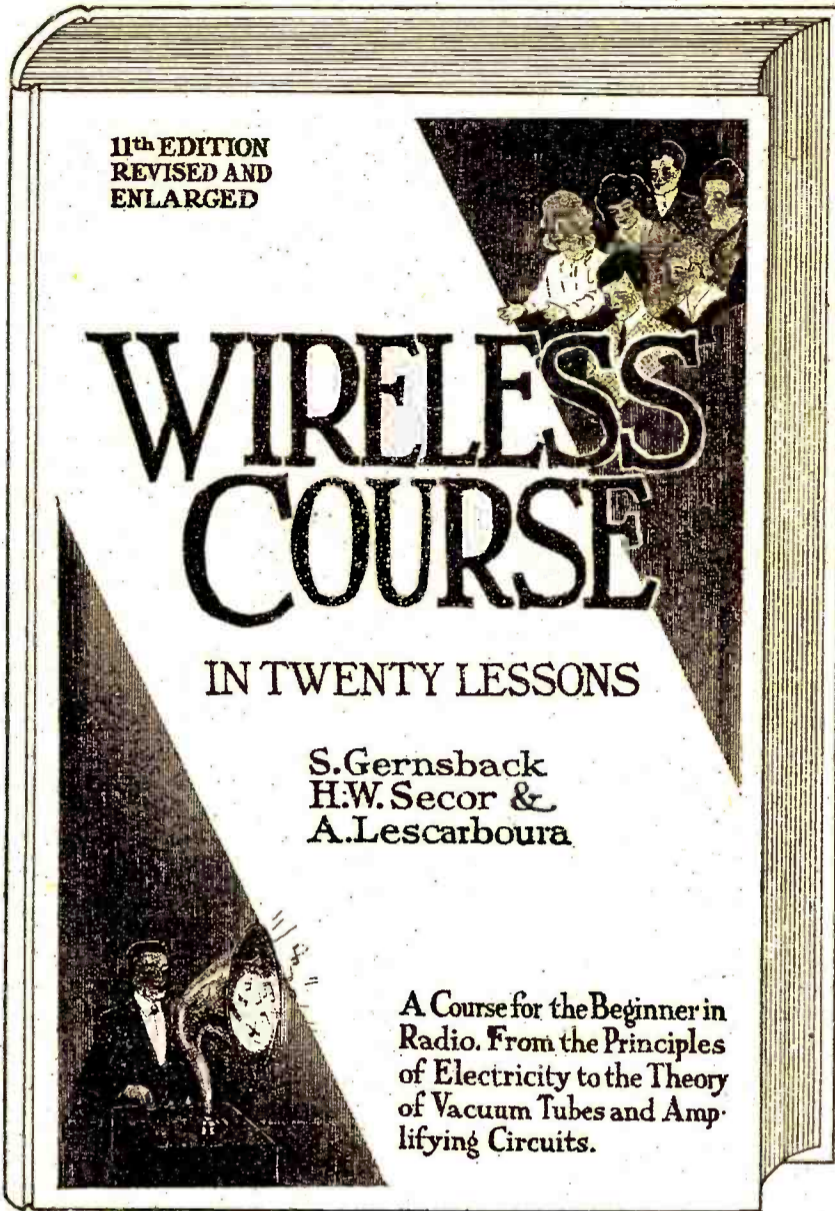

WIRELESS COURSE

in 20 Lessons

By

**S. GERNSBACK, H. W. SECOR,
A. LESCARBOURA**

Beautifully Stiff Bound
in Red Cloth
Gold Stamped
Size 7 x 10 inches
160 Pages
20 Lessons
360 Illustrations
30 Tables
Price \$1.75 Prepaid



Exactly the Same Books
But Soft Bound,
and not Gold Stamped
Price \$1.25, Prepaid

The Experimenter Publishing Co., Inc.

53 PARK PLACE
NEW YORK, N. Y.

THIS Course has been considerably revised in order that it meet some of the many important changes which have occurred in Radio Telegraphy and Telephony within recent years. Much valuable data and illustrations concerning the Vacuum Tube has been added. This comprises the theory of the Tube as a detector and as an amplifier, and in addition has been included modern amplification circuits of practical worth. Incidentally, space has also been devoted to the development of the Radio Compass as operated and controlled by the United States Navy with its consequent great aid to present-day navigation.

The beginner and general student of radio will find this Course of great value in securing the necessary fundamentals of a most fascinating and instructive vocation, or avocation—as the case may be. Radio holds out considerable inducements as a career.

The Publishers

The Experimenter Publishing Co., Inc.
53 Park Place, New York, N. Y.

Enclosed find \$1.75 for which send me one copy of
 stiff \$1.25
 soft bound WIRELESS COURSE. Postpaid.

Name

Town

Address

State

R. N.—8-22

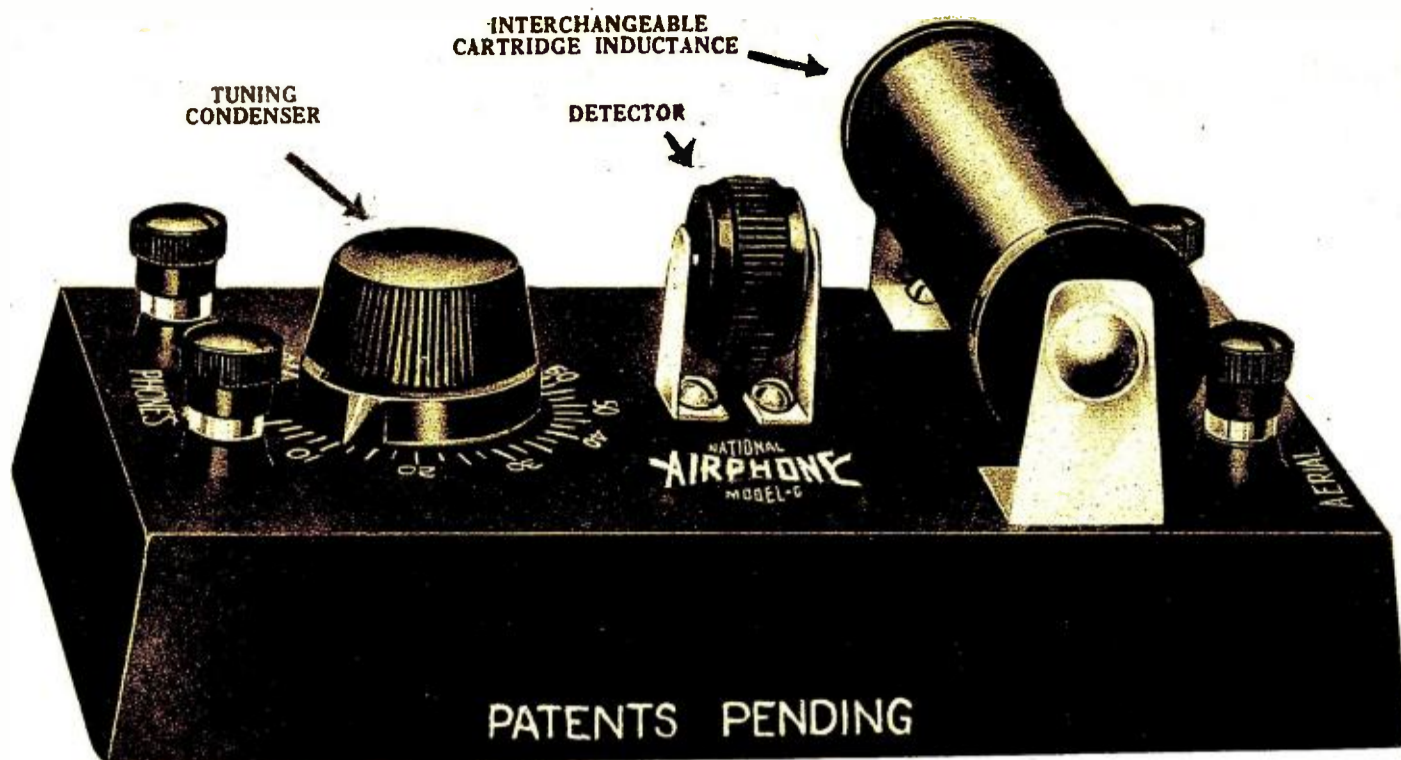

Price \$12.50

(Without Phones)

NATIONAL AIRPHONE

(MODEL G)

**A New Radiophone Easily Operated by a Child
Practical for the Office and Home**

To operate simply connect aerial, ground and head-phones. Will receive radio broadcast entertainments and commercial reports within a radius of 25 miles; Code signals 1000 miles and over depending upon coils used.

Outstanding Points of Superiority:

1. Most Compact Radiophone Receiving Set Made: 6½" long, 4¼" wide, 2¾" high—small enough to put in coat pocket or desk drawer.
2. Rugged construction throughout, nothing to get out of order, insuring long life in service.
3. Entire casing constructed of hard rubber composition. No wood, no warping, no losses through leakage.
4. Ultra-sensitive Foolproof Detector; entirely enclosed in composition case. Air and dustproof, no fussy minerals, no Catwhisker, no balls nor spring. To adjust for maximum sensitivity simply rotate the black disk slowly.
5. Elimination of all switches, current taps and switchpoints prevents loss of electrical energy.
6. Use of interchangeable cartridge coils gives wide range over which radiophone broadcast or radio telegraph signals can be heard. 25 miles or over for radiophone concerts; up to 1000 miles for telegraph signals depending upon coils used.
7. Two Cartridge tuners, wave length 150 to 400 meters, supplied with each outfit; one takes in general broadcasting stations (360 meters), the other from 500 to 1000 meters.
8. Variable Mica Condenser used is acme of simplicity—high capacity, impossible to short-circuit.
9. Anyone without previous experience can operate a NATIONAL AIRPHONE, no delicate adjustments necessary, no fussing.

TRADE MARK **NATIONAL AIRPHONE** REG. U.S. PAT. OFF.
CORPORATION

18 Hudson Street
NEW YORK

NOW READY! The Fourth Edition of the NOW READY!

Consolidated Radio Call Book

**Very Greatly Enlarged
With Seven Two-Color Radio Maps**

280 pages (88 pages more than the 3rd edition), better paper, stiff covers, etc.
25,000 Copies

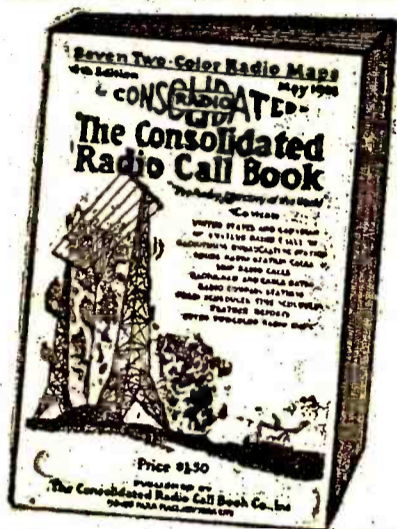

Some of the special information contained in the new book: All Amateur Radio Calls of the United States and Canada; Every Vessel, Coast Station, and Radio-Compass Station in the World; Radiophone Broadcasting Stations of the United States; Every High-Power Station in the World; Special Land Stations of the United States; Time Signals, Hydrographic and Weather Reports of the United States and Principal Foreign Countries; International Abbreviations; Assignment of International Calls; Press Schedules; Radiogram Rates; Cable Rates; International Morse Code and Continental Signals; and Complete General Information covering Distress Calls, International Safety Signal, Use of 800-Meter Wave Length, Amendments and Changes in Various Governmental Regulations, How to Determine Charges on Radiograms, Free Medical Advice by Radio to Vessels, and much other useful information.

The Consolidated Radio Call Book is the only book in print officially listing all the Radio calls as issued by the Bureau of Commerce. Every vessel and land station in the world is represented and listed alphabetically, according to name of vessels or land stations, and according to call letters. The New Radiophone Broadcast Section is particularly complete and gives all available information concerning Calls, Wave Lengths, Programs, etc.

Every Amateur Call in the United States and Canada Is Listed

SPECIAL RADIO MAP SECTION

Contains Five Two-Color Continental Maps showing All Stations thruout the World Handling Commercial Traffic with their Calls; a Two-Color Map showing the Amateur Radio Districts of the United States and the Principal Radiophone Broadcasting Stations with their Calls; and a Map of the United States Weather Forecast Zones.

The third edition of 10,000 copies was exhausted in two weeks. The fourth edition is selling just as quickly. Don't wait until it is all gone. Order at once, either direct from us or from your favorite dealer.

Price \$1.50 Prepaid

Order Direct from us or for sale by the following responsible Dealers:

- | | | | |
|---|---|--|---|
| Alamo Sales Corp. Indianapolis, Ind. | Ferro Co., R. F. N. Y. City | Meyberg Co., Leo J. San Francisco, Cal. | Rose Radio Supply New Orleans, La. |
| Am. Electro Tech. App. Co., N. Y. City | Fergus Elec. Co. Zanesville, O. | Milnor Elec. Co. Cincinnati, Ohio | Roy News Co., Fred J. Toronto, Can. |
| American Hdw. Stores, Bridgeport, Conn. | Findley Electric Co. Minneapolis, Minn. | Mohawk Elec. Sup. Co., Syracuse, N. Y. | Sands Electric Co. Wheeling, W. Va. |
| Andrea & Sons, Julius, Milwaukee, Wis. | Fleron & Son, M. M. Trenton, N. J. | Montgomery-Ward & Co. Chicago, Ill. | Sayre-Level Radio Co. Phila., Pa. |
| Anthracte Radio Shop Scranton, Pa. | Fuller Co., Seth W. Boston, Mass. | Morehouse-Martens Co. Columbus, Ohio | Schmidt & Co., R. Rochester, N. Y. |
| Associated Merchandising Corp., N. Y. C. | Gainday Elec. Co. Pittsburgh, Pa. | National Radio Corp. Atlanta, Ga. | Sears, Roebuck & Co. Chicago, Ill. |
| Atlantic Radio Co. Boston, Mass. | Galveston W'less Sup. Co., Galveston, Tex. | Nat'l Radio Institute, Washington, D. C. | Shotton Radio Mfg. Co. Scranton, Pa. |
| Bamberger & Co., L. Newark, N. J. | Greene, Jos. E. Boston, Mass. | New England Motor Sales Co., Green-
wich, Conn. | Smith Radio Lab. Sarnia, Ont., Canada |
| Banister & Pollard Co. Newark, N. J. | Gurd & Co., Wm. London, Canada | New Era Shop Milwaukee, Wis. | Smith Novotay Elec. Inc., Charlotte, N. C. |
| Beckley-Balston Co., The Chicago, Ill. | Hall Electric Co., Wm. Dayton, O. | Newman-Stern Co. Cleveland, O. | So. California Elec. Co. Los Angeles, Cal. |
| Benwood, Specialty Co. St. Louis, Mo. | Hartford Elec. Sup. Co. Hartford, Conn. | Nichols Radio Sup. Co., Big. Green, Ky. | Southern Elec'l Sup. Co., San Diego, Cal. |
| Bluebird Electric Shop, Jersey City, N. J. | Hatfield Electric Co. Indianapolis, Ind. | Nola Radio Co. New Orleans, La. | Southwest Radio Sup. Co. Dallas, Tex. |
| Brode Electric Co. Los Angeles, Cal. | Heustis, A. E. Fitchburg, Mass. | Noll & Co., E. P. Philadelphia, Pa. | Sprott-Shaw Schl. Vancouver, B. C. |
| Brown, J. Edw. Glenbrook, Conn. | Hickson Electric Co. Rochester, N. Y. | Northern Radio & El. Co., Seattle, Wash. | Standard Drug Co., The Detroit, Mich. |
| Bunnell & Co., J. H. New York City | Hiro Wireless Sup. Co. Marion, Ill. | Northwest Radio Serv. Co., Seattle, Wash. | Steiner Elec. Co. Chicago, Ill. |
| California Elec. Co., San Francisco, Cal. | Holt Electric Util. Co., Jacksonville, Fla. | N. S.W. Bookstall Co. Sydney, Australia | Steinman Hardware Co. Lancaster, Pa. |
| Capital Radio Sup. Co. Indianapolis, Ind. | Hommel-Ludwig & Co. Pittsburgh, Pa. | Paramount Radio Sup. Co., Atlantic City | Sterling Electric Co., Minneapolis, Minn. |
| Carter Electric Co. Atlanta, Ga. | Hook Drug Co. Indianapolis, Ind. | Pearlman's Book Shop, Washington, D. C. | Stubbs Electric Co. Portland, Ore. |
| Central Radio Co. Independence, Mo. | Huey & Philip H'dware Co., Dallas, Tex. | Penn Radio Apparatus Co., Reading, Pa. | Sunbeam Elec. Sup. Co. N. Y. City |
| Chase, Geo. H. Newport, R. I. | Hughes Elec'l Corp. Syracuse, N. Y. | Penn. Marconi Wireless Schl. Phila., Pa. | Tuska Co., C. S. Hartford, Conn. |
| Chesapeake Elec. Co. Baltimore, Md. | Jenkins, Lester I. New Bedford, Mass. | Pettingell-Andrews Co. Boston, Mass. | Union Elec. Sup. Co. Providence, R. I. |
| Chicago Radio Ap. Co. Chicago, Ill. | Kesselman-O'Driscoll Co., Milwaukee, Wis. | Phila. Schl. of Wireless Tele., Phila., Pa. | United Elec. Stores Co. Braddock, Pa. |
| Cleveland Co., L. W. Portland, Me. | Keubler Radio Co. Toledo, O. | Piedmont Electric Co. Asheville, N. C. | United Electric Sup. Co. E. Pittsburgh, Pa. |
| Cloud & Son Macy, Ind. | Killoch Co., David New York City | Pioneer Electric Co. St. Paul, Minn. | United Elec. Sup. Co. Boston, Mass. |
| Con. Radio & Elec. Corp. N. Y. City | King Radio Co. Pittsburgh, Pa. | Pitts Co., F. D. Boston, Mass. | U. S. Radio Co. Pittsburgh, Pa. |
| Continental Elec. Sup. Co., Washington,
D. C. | Klaus Radio Co. Eureka, Ill. | Pitts. Radio Sup. Co. Pittsburgh, Pa. | Virginia Novelty Co., Martinsburg, W. Va. |
| Daily Battery & Equipment Co., Pitts-
burgh, Pa. | Kluge, Arno A. Los Angeles, Cal. | Port Arthur Radio Lab., Port Arthur, Tex. | Warner Bros. Oakland, Cal. |
| Delancey-Felch & Co. Detroit, Mich. | Knoxville Radio Co. Knoxville, Tenn. | Post Office News Co. Chicago, Ill. | Western Radio Co. Kansas City, Mo. |
| Delancey-Felch & Co. Pawtucket, R. I. | Kusel Co., D. & F. Watertown, Wis. | Precision Equipment Co. Cincinnati, O. | West'n Radio Elec. Co., Los Angeles, Cal. |
| Detroit Electric Co. Detroit, Mich. | Lehigh Radio Co. Bethlehem, Pa. | Quaker Light Sup. Co., The Phila., Pa. | Wetmore-Savage Co. Boston, Mass. |
| Dewey Sptg. Goods Co. Milwaukee, Wis. | Liberty Incandescent Sup. Co., Pittsburgh,
Pa. | Radio Distributing Co. Newark, N. J. | Wheeler Green Electric Co., Rochester,
N. Y. |
| Doubleday-Hill Elec. Co. Pittsburgh, Pa. | Liberty Radio Sup. Co. Chicago, Ill. | Radio Electric Co. Pittsburgh, Pa. | Whitall Elec. Co. Springfield, Mass. |
| Dreyfuss Sales Co. New York City | Linsch Elec'l. Sup. Co. St. Louis, Mo. | Radio Equipment Co. Boston, Mass. | Whitall Electric Co. Westerly, R. I. |
| Duck & Co., Wm. B. Toledo, O. | Litscher Elec. Co., C. J. Grand Rapids,
Mich. | Radio Equipmt. & Mfg. Co., Minneapolis | Williamson Elec. Co. Seattle, Wash. |
| E. S. & E. Co. Hartford, Conn. | Ludwig Hommel & Co. Pittsburgh, Pa. | Radioelectric Shop Cleveland, O. | Wilmington Elec. Spec. Co., Wilmington |
| Electro Importing Co. N. Y. City | Luther, H. E. Centerville, Ia. | Ray-Di-Co. Chicago, Ill. | Wilson Co., Harold K., Grundy Center,
Iowa. |
| Elite Electric Shop El Paso, Tex. | Manhattan Elec. Sup. Co. Toledo, O. | Reynolds Radio Denver, Colo. | Winner Radio Co. Aurora, Colo. |
| Erie Book Store Erie, Pa. | Marshall-Gerken Co. Toledo, O. | Reuter Electric Co. Cincinnati, O. | Wireless Mfg. Co. Canton, O. |
| Farley & MacNeill Boston, Mass. | McCarthy Bros. & Ford, Buffalo, N. Y. | R. I. Elec. Equip. Co.- Providence, R. I. | Wolfe Electric Co. Omaha, Neb. |
| Farrington & Clark Boston, Mass. | McMillan Bros. Pittsburgh, Pa. | Riverside Laboratory Milwaukee, Wis. | Zamoiski Co., Jas. M. Baltimore, Md. |
| Federal Elec. Sup. Co. Detroit, Mich. | Merchant, A. P. & Co. Boston, Mass. | Robertson-Cataract El. Co., Buffalo, N. Y. | Zibart Bros. Nashville, Tenn. |

Published by

Consolidated Radio Call Book Co., Inc.
96-98 Park Place, New York City

and a negative ion will correspondingly be produced.

An electron (negative electricity) is always attracted by a positively charged body and, on the other hand, is repelled by a negatively charged body—or another electron. This is in accordance with the long established law that unlike charges of electricity attract one another, while like charges of electricity repel one another. These effects are said to be due to stresses in the medium in the intervening space.

Electrons may travel from atom to atom within a conductor, or, as will be seen later, may be projected (seemingly) across space similar to shots from a gun. In either case the movement of electrons constitutes a current. It is important to note here, however, that the direction of the *electron current*, being from negative to positive by reason of the fact that the electrons are negative charges, is opposite to that of an *electric current* as considered in practice. This condition is due to the fact that electricity was commonly accepted as passing from the positive end to the negative end of a conductor long before general recognition of the electron theory. As a result, though it is now agreed that a current of electricity is due to electrons moving from *negative to positive*, the direction of an electric current is still spoken of as being from *positive to negative* in practice. This is not as unfortunate a condition as may at first appear and in no way hinders the design or understanding of the operation of electrical apparatus. Nevertheless it is good to keep in mind the distinction between the *electron current* (supposedly an actual movement of electricity) and the *electric current* (practical term indicative of a movement, but not specific).

From the foregoing it is seen that all bodies really are, to a greater or less extent, conductors of electricity. It is customary, however, to divide them into two classes: (1) Those that readily convey a charge of electricity from one point to another and (2) those that offer considerable opposition or resistance to such a transfer or current of electricity. The first mentioned are the so called *conductors*; the latter *non-conductors*, *insulators*, or *dielectrics*.

In accordance with the electron theory a conductor is considered to be a substance in which the electrons are not tightly bound to the atoms, but are relatively free to move from atom to atom upon the application of a suitable electromotive force (force to move electricity). Similarly an insulator is believed to be a substance in which the electrons are held rather tightly within their atoms, thereby tending to prevent any electronic motion in the form of a current.

It was previously pointed out that electrons may move across space, as well as through a solid conductor. This may be readily understood from what follows. If a conductor is suitably heated, as for instance, the filament in a common incandescent electric lamp, some of the electrons will overcome the force which normally keeps them within the material of the filament and will escape into the surrounding space. Consequently it is found that the space about the hot filament becomes a good conductor of electricity.

Suppose, now, that a positively charged metal plate is sealed into the incandescent lamp so as to be near the filament. The electrons which issue from the filament, being negative, will then be attracted by the positively charged body, thereby establishing a current across the gap between the heated filament and the cold electrode. On the other hand, if the second electrode is made negative with respect to the filament, the electrons will be repelled by the negatively charged body and no current will flow. Thus it is evident that this device, consisting of a hot and cold electrode in a glass bulb from which the air has been exhausted, is uni-directional in

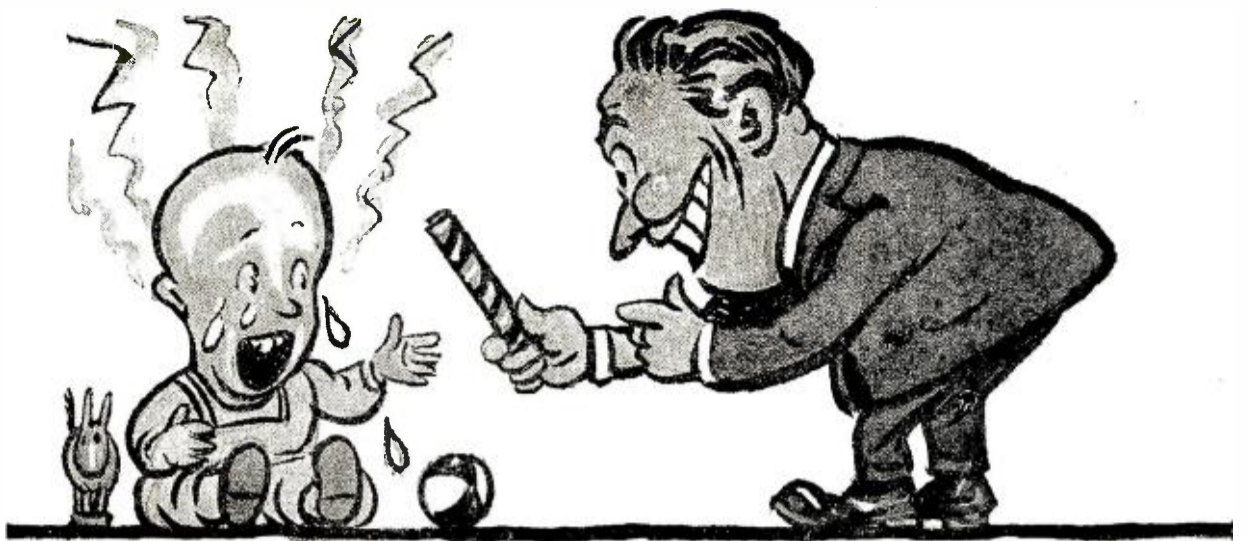

The end of a perfect howl—

THE squalls of a two year old are as music to the ear beside the howling demonstration put up by a fractious radio set. And how a set can howl unless one offers the soothing influence of the proper amplifying transformer.

Most any transformer can amplify sound, but it will also amplify the stray fields which produce howling and distortion. It takes the Acme Amplifying Transformer with its specially constructed iron core and coil to put an end to the howls and yowls. Only when you add the Acme do you get the realistic tone and volume so markedly absent in the ordinary radio receiving set.

The Acme Radio Frequency Transformer greatly increases the range of any receiving set, either vacuum tube or crystal detector type. The Acme

Audio Frequency Transformer produces not only volume, but reality of tone. It is indispensable to the satisfactory operation of loud speaking devices. The combination of one or more stages of Acme Radio and Audio Frequency Transformers assures the maximum of range, of volume and of reality in tone.

The Acme Apparatus Company, pioneer radio engineers and manufacturers, have perfected not only Radio and Audio Frequency Transformers as well as other receiver units and sets, but are recognized as the foremost man-

ufacturers of Transmitting Apparatus for amateur purposes. Sold only at the best radio stores. The Acme Apparatus Company, Cambridge, Mass., U.S.A. New York Sales Office, 1270 Broadway.

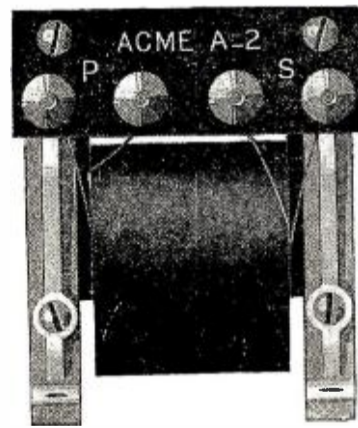

Type A-2 Acme Amplifying Transformer
Price \$5 (East of Rocky Mts.)

ACME

for amplification

THE RADIO READING COURSE

A THOROUGH RADIO EDUCATION WITHOUT LONG, TEDIOUS STUDY

All the Data in Simple, Easily-Understood and Interesting Style in Low-Priced Course

While you may have no desire to spend the time and effort to study radio in all its branches and attempt to become an "expert," you do want to know the fundamental and practical things that will help you get the utmost pleasure from your hobby—to be able to instantly locate and correct troubles — to save money on parts and units by doing your own work.

You can now get all the working details without long, tedious study. The Radio Reading Course in five complete Lecture Books supplies in an actually entertaining way the most helpful, comprehensive and correct information on the subject. It gives you all the necessary data through simple, non-technical language and drawings to intelligently choose, design, construct, operate and maintain radio reception apparatus.

Written by a foremost radio engineer, inventor and "father" of radio telephony, it takes you quickly and smoothly over the ground, giving you a wonderful grasp of the whole subject. Not a re-written left-over of radio of years ago, but of radio as it is known and practised today in the great radio research laboratories.

Instructor, Guide and Reference

You continually run into trouble with your apparatus. Your set doesn't func-

tion right. You lose half the pleasure that can be yours. You forever spend money to get your apparatus into condition. With The Radio Reading Course as instructor, guide and for reference, you will know how to analyze trouble symptoms yourself and take the proper steps to correct them; you will design and make parts and units that will add immeasurably to the scope and efficiency of your set, and at the same time save large sums of money that you would spend in stores. You will actually save much more than the price of the Course.

Make This Small Investment

If you want to really enjoy radio and get RESULTS, make this small investment which will be returned many times over. Very moderately priced at \$4.25 for the complete Course, which is cheaper for you than buying miscellaneous books and pamphlets. Take advantage of this opportunity to get this splendid radio training. You need The Radio Reading Course right beside your set, so send your order NOW.

RADIO COURSES, INC., Dept. A6,
15 East 40th Street, New York City.

Gentlemen: Herewith, \$4.25 postal money order (or check), for which forward at once The Radio Reading Course, complete in Five Lecture Books.

NAME.....
STREET.....
CITY AND STATE.....

operation and is, therefore, a *rectifier*. Quite naturally, this fact led to the employment of the *two-electrode vacuum tube*, as the device is commonly called, as one of the early detectors for radio telegraphic reception.

By the introduction of a third electrode between the filament and plate of the vacuum tube, we produce the type of detector and oscillation generator now so universally used for radio telegraphic or radio telephonic reception and transmission. The additional electrode, however, must be constructed in the form of a wire grid, perforated metal plate, metal gauze cylinder, or otherwise designed so that its position may not obstruct the passage of electrons from filament to plate under favorable conditions.

It would not be in strict accordance with the method of modern science to state with certainty that the electron, as small as it may be, is indivisible. Such dogmatic assertions were once made by some teachers and scientists with respect to the atoms of the elements, but far seeing physicists as a rule were always careful to avoid being committed to the belief that the ultimate had been reached with the atoms of chemistry. It was not, of course, until recently that a basis existed for asserting anything about the insides of the atom, and hence it was unnecessary to state more than that the smallest thing which took part in chemical reactions was apparently the atom.

In much the same manner, the electron has been considered as the smallest quantity of electricity found to be invariably carried by the atom of an element in electrolysis. Nothing, however, has been said about its necessary ultimateness. Evidence has lately been presented which purports to show that smaller electric charges than the electron exists; that is, there is a *sub-electron*. Thus the reader will be left with something to think about. *What will the future bring?*

Correspondence from Readers

(Continued from page 235)

The standard key is not what would be selected by an AP man, but becomes easy of operation with use and can't be beat when the air is bumpy.

I have operated in a plane all along the coast to Hampton Roads and return besides considerable local flying, without coming down to ten a minute.

If Mr. Davenport will agree to copy I'll send a *good readable* twenty-five on an aircraft key at any time.

The point at issue may have been intended as a knock or only a "wise crack," but in either case it looks bad in print, wherefore a protest is entered by the radio gang.

F. DICKINSON	NELSON M. COOKE
PAUL C. RISH	GEORGE M. SEMMENS
MYRON N. FLEMING	MYRON A. WRIGHT
W. E. ROLLER	CHAS. L. DAY
GORDON GLENN	W. E. MARTIN
FORREST V. BELL	BRUCE E. BUTTON
M. H. DUNBAR	E. V. SIZER
	P. F. RANDOLPH

Naval Air Station, Sqd. V.,
Pensacola, Fla.

WIRELESS TELEPHONY IN NEW ZEALAND

Editor, RADIO NEWS:

A fair number of your excellent publications find their way out here through news agents, etc., and are appreciated and well read by the amateurs who get them.

We all look forward to the latest trials, etc., made by the amateurs and commercial companies, as very little transmission is done out here in New Zealand.

Outside of the Dunedin University, we are the only folks in New Zealand sending out wireless telephony and music. Our aerial is 100' overall. It is about 50' from the ground,

Holtzer-Cabot

NATIONAL RADIO TELEPHONE

The experience gained through the extensive manufacture for many years of telephones for navy and other exacting service enables us to offer

RADIO TELEPHONES

that are correctly designed and properly built for receiving broadcasted concerts, lectures, etc., satisfactorily.



Demand *Holtzer-Cabot* Radio Telephones

Order Through Your Dealer

The Holtzer-Cabot Electric Co.
BOSTON, MASS.

CHICAGO
PHILADELPHIA

NEW YORK
SAN FRANCISCO

BALTIMORE
CLEVELAND

S-144



WIRELESS APPLIANCES CO.

OLD COLONY BUILDING
CHICAGO

Manufacturers and Distributors

Plugs
Jacks
Head Sets
Rheostats
Condensers



Stop Buzzing and Sizzling

FORMICA insulation for Radio use is perfect insulation! It prevents buzzing, sizzling and noise that makes it hard to hear over your radio telephone. There are no weak places in Formica panels. They are not affected by moisture and weather conditions and do not deteriorate. They will give perfect service for years.

Formica is the most widely used radio insulation. It is approved by the Navy and the Signal Corps. It is a thoroughly high quality product—the finest possible insulating material all the way through. It contains no absorbent matter that will take up water and lose its insulating strength through humidity and moisture. Formica panels have a handsome gloss or satin finish—black and natural brown.

DEALERS—We have now in operation an addition to our plant which doubles our previous capacity. Back orders for Formica are being shipped rapidly. We always do our utmost to serve you promptly.

THE FORMICA INSULATION COMPANY
4618 SPRING GROVE AVENUE
CINCINNATI, OHIO

SALES OFFICES

50 Church Street, New York, N. Y.
9 South Clinton Street, Chicago, Ill.
414 Finance Building, Cleveland, Ohio

1042 Granite Bldg., Rochester, N. Y.
422 First Avenue, Pittsburgh, Pa.
Sheldon Building, San Francisco, Cal.

932 Real Estate Trust Bldg., Phila., Pa.
321 Title Building, Baltimore, Md.
415 Ohio Building, Toledo, Ohio.

FORMICA

Made from Anhydrous Redmanol Resins

SHEETS TUBES RODS

ABC Standardized Radio PARTS

ABC Parts offer the radio user the very highest quality, due to the fact that all ABC radio products are manufactured in our own splendidly equipped factory.

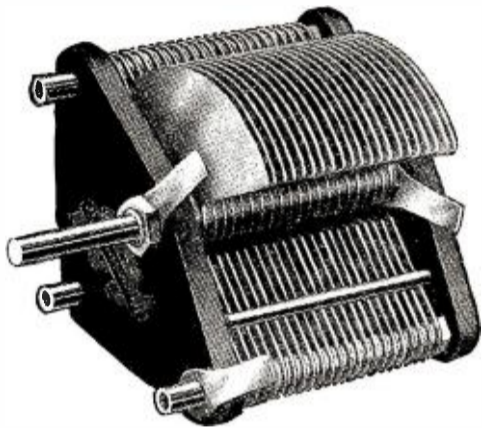

ABC Variable Plate Condensers

These Condensers are distinguished by many special features from any other on the market. While their appearance can be imitated, the quality is found in the ABC alone.

Prices

- No. 650-43, with 43 Plates, \$5.00
- No. 650-21, with 21 Plates, 3.75
- No. 650-11, with 11 Plates, 3.00
- No. 650-3, with 3 Plates, 2.25

Use an ABC Condenser to secure most satisfactory results.

ABC Transformer

Magnetic leakage is impossible in this Transformer, designed to provide the correct ratio of impedance for present-day VTs. **Price \$7.00**

ABC Head Sets

These consist of two standard Murdock head phones with improved Signal Corps type head band. Order by number.

- No. 770-L2—2000 ohms—\$8.50
- No. 770-L3—3000 ohms—10.50

Ask your dealer for ABC Parts, or send your order direct to us. Also write for ABC Parts Catalogue.

Jewett Manufacturing Corp.
342 Madison Ave., Dept. R8,
New York

but only 15' above the nearest roof, so you can see it is very medium indeed. We have three wires spaced 3' apart.

The ground is connected to the water pipes and also a 7/18 wire is put down the drain and two of the tin roofs are connected into the earth circuit.

Using a de Forest O.T.3 set and three Moorhead tubes of 500 volts on the plate and six volts on the filament, we radiate .7 amp. on 270 meters. Previous to connecting up two roofs in the earth circuit, our maximum radiation was between .5 and .6 amperes.

Every Monday and Friday evening from 7:30 to 9 p. m. we send out gramophone music and speech and have had some very fair distances, considering the position of our aerial. Wellington is situated in a valley with hills all around, up to about 1,600' high.

Amateurs have reported us readable at Wangauni, which is about 180 miles away, and amateurs in Dunedin have heard us, Dunedin being nearly 400 miles away.

As we do not use our full radiation (we send out on .6 amp.) the results are very fair indeed, using such small power.

A large set is on order (a Type O.T.20) when we expect to be able to do some very serious work and get greater distances.

The regulations out here state that the overall length of the aerial must not be more than 100', so we cannot put up a bigger aerial at present. The length of the flat-top lead-in and ground lead must not be more than 100'.

However, using a "T" aerial only one half of the flat top is counted. This means that an amateur can get 100' of flat top in a "T" aerial with a 30' lead-in and 20' earth lead, and just come within the regulations.

Even on these aerials very good results have been obtained. Many of the amateurs on one tube using a three coil circuit receive up to 6,000 miles and some of them hear Lafayette, Nauen and San Diego.

We look forward to the amateurs in U. S. A. to reach as far as Scotland, as their power is practically unlimited and the aerial can be any size.

Shall be very pleased to hear from the amateurs who are doing great distances using phones, with a copy of their tests between U. S. A. and Scotland.

CHARLES E. FORREST,
International Electric Company,
53 Courtenay Place,
Wellington, New Zealand.

Multiple Wave Lengths to Improve Broadcasting

(Continued from page 245)

The accompanying diagram shows the idea in a simple way. Experiments would have to be carried out to ascertain whether the several different wave-lengths at the broadcasting station could be radiated successfully from a single antenna, or whether a different aerial should be used for each wave-length radiated. For each instrument, such as a violin, saxophone, piano, etc., or for each singer in a quartet, there would be a collecting horn attached to a microphone in the usual manner. The respective microphones would be connected to individual V. T. transmitting sets, adjusted for different wave-lengths, such as 300 meters for the bass viol; 350 meters for the saxophone; 400 meters for the violin; and 450 meters for the piano.

At the receiving stations, these several different wave-lengths are collected, let us say, on a single antenna and the individual wave-lengths weeded out and directed to their respective loud speakers, through suitably tuned V.T. receiving sets, numbered 1, 2, 3 and 4 in diagram, the four receiving sets in this case being tuned for the four wave-lengths transmitted, viz., 300, 350, 400, 450

SPECIAL DISCOUNT 10%

Cardboard Tubes, Seamless, Gray, 1/8-inch wall, 2 1/2x12, 25c; 3x12, 30c; 3 1/2x12, 35c; 4x12, 40c; 4 1/2x12, 45c; 5x12, 50c; 5 1/2x12, 55c; 6x12, 60c.

Contact Points, Nickeled..... 6 for 30c
Contact Points, Brass..... 6 for 25c
Stops, Nickeled..... 2 for 10c
Phone Binding Posts, Nickeled, each..... 15c
Binding Posts, H.R. Top, Nickeled, each..... 10c

ROUND BRASS RODS, POLISHED
THREADED
1/8x13.... 15c 1/8x18.... 20c 1/8x22.... 25c

SQ. BRASS RODS, POLISHED AND DRILLED
BRASS SLIDERS
1/4x 7.... 15c 1/4x 7.... 20c 1/4x 7.... 25c
1/4x 9.... 15c 1/4x 9.... 20c 1/4x 9.... 25c
1/4x13.... 20c 1/4x13.... 25c 1/4x13.... 30c

MAGNET WIRE

B. & S. Ga. Enameled	Double Cotton		Double Silk	
	1/2 lb.	1/4 lb.	1/2 lb.	1/4 lb.
No. 18	—	—	\$.75	—
No. 20	\$.60	\$.30	.80	\$1.00
No. 22	.65	.35	.85	1.05
No. 23	—	—	—	1.10
No. 24	.70	.40	.90	1.10
No. 26	.75	.45	.95	1.15
No. 28	.80	.50	1.00	1.20
No. 30	.85	.55	1.05	1.25
No. 32	—	.60	—	.75

Prices net; parcel post prepaid anywhere in U. S. Send for our catalog FREE.

THE KING RADIO CO.

113 Sheridan Ave., PITTSBURGH, PA.

EINSTEIN

Has the dope on **RELATIVITY**
We have the dope on **RADIO**



Longer Distance
Clearer Signals
Thru More Interference
Non-infringing Apparatus

Are you from "Missouri"?
Write us today!

SCIENTIFIC ENGINEERING ASSOCIATION

817 MAIN STREET CINCINNATI, OHIO



Firco Radio Apparatus

For sale by all prominent dealers

JOHN FIRTH & CO., Inc.

Pioneers since 1901

709 6th Avenue

New York

RADIO DEALERS AND MANUFACTURERS

We have them—all parts needed for the radio trade promptly delivered.

Send us your requirements for prices

SMITH ENGINEERING CO.

One Union Square

New York City

Better Radio Receiving

Improve the Reception of Your Radio Set



Every radio enthusiast desires to get the most out of his set, and feels unusually proud when he is able to secure better results than his neighbor. A radio receiving set is only as good as the receivers used with it. To secure maximum results, use a set of Kellogg radio receivers, which are built by the Kellogg Switchboard and Supply Company for radio use only.

Kellogg radio receivers are unusually sensitive and require minimum of pressure on the ears, resulting in clear, distinct transmission. The extreme lightness in weight is a noteworthy feature to any one listening to a radio concert. Heavy, bulky receivers become most disagreeable. The head band is strong, of neat construction, and the receivers easily ad-

Listen in—On the World—with Kellogg

justed for the most comfortable position. Kellogg sets will not disarrange a lady's head dress. Kellogg radio receivers are the choice of the professional, as well as the amateur, due to their many points of superiority.

Order a set today. If your dealer does not have them, write us.

Kellogg Microphones



Kellogg No. 21 Microphone is a hand microphone with a switch in the handle and made up to government specification and will stand extraordinary severe service. This product is so arranged as to prevent the mouth being placed inside the transmitter mouthpiece, thus assuring perfect modulation.

Kellogg Tube Sockets

Kellogg molded tube sockets fit all standard four prong vacuum tubes. Four German Silver springs with rounded ends are firmly held in position in deep grooves. Cannot touch mounting surface. Binding posts plainly marked for wiring.



Kellogg sockets are 2 3/16 inches square with round corners, with a total depth of 1 1/4 inches.

Kellogg Insulators



Kellogg No. 3 strain insulators consist of Bakelite rods in which are firmly inserted metal end rings. These insulators stand a direct pull of approximately 350 pounds.

Nos. 4, 5 and 6 are the same as No. 3 except the length. The lengths are: No. 3, 3 inches; No. 4, 2 inches; No. 5, 4 inches; and No. 6, 6 inches.

*Dealers and Jobbers
Write for Your
Discounts*

*We also manufacture
radio jacks, plugs,
condensers and other
radio accessories*

The Kellogg Company announce that in addition to their standard head set of 2400 ohms that lists at \$12.00 they are now building a 1200 ohm head set which lists at \$8.00.

Kellogg Switchboard and Supply Company

Manufacturers of Standard Telephone Equipment

CHICAGO, ILLINOIS

Electrical Experts EARN \$12 to \$30 a Day

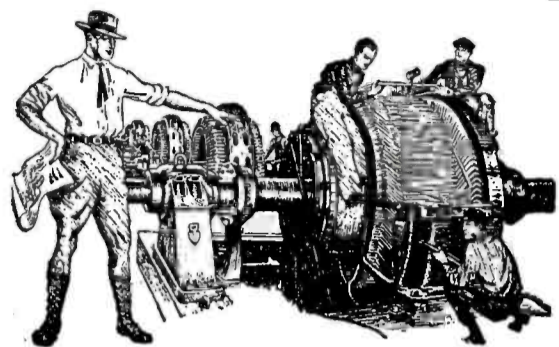

What's YOUR Future?

Trained "Electrical Experts" are in great demand at the highest salaries, and the opportunities for advancement and a big success in this line are the greatest ever known. "Electrical Experts" can earn \$70 to \$200 a week. Fit yourself for one of these big paying positions—

BE AN "ELECTRICAL EXPERT"

Today even the ordinary electrician—the "screw driver" kind—is making money—big money. But it's the trained man—the man who knows the whys and wherefores of Electricity—the "Electrical Expert"—who is picked out to "boss" ordinary electricians—to boss the big jobs—the jobs that pay.

\$3,000 TO \$10,000 A YEAR

Get in line for one of these "Big jobs," by enrolling now for my easily-learned, quickly grasped, right-up-to-the-minute, Spare-Time Home-Study Course in Practical Electricity.

AGE OR LACK OF EXPERIENCE NO DRAWBACK

You don't have to be a College man; you don't have to be a High School Graduate. My course in Electricity is the most simple, thorough, and successful in existence and offers every man regardless of age, education, or previous experience, the chance to become, in a very short time, an "Electrical Expert," able to make from \$70 to \$200 a week.

I GIVE YOU A REAL TRAINING

As Chief Engineer of the Chicago Engineering Works, I know exactly the kind of training a man needs to get the best positions at the highest salaries. Hundreds of my students are now earning \$3,500 to \$10,000. Many are now successful ELECTRICAL CONTRACTORS.

YOUR SATISFACTION GUARANTEED

So sure am I that you can learn electricity—so sure am I that after studying with me you can get into the "big money" class in electrical work, that I will guarantee under Bond to return every single penny paid me in tuition if, when you have finished my Course you are not satisfied it was the best investment you ever made.

FREE—ELECTRICAL WORKING OUTFIT—FREE

I give each student a Splendid Outfit of Electrical Tools, Materials and Measuring Instruments absolutely FREE. With me you do practical work right at the start—at home. You start right in after the first few lessons to WORK AT YOUR PROFESSION in a practical way.

FREE RADIO COURSE

An-up-to-the-minute course in Wireless Telephony and Telegraphy given free with my great Electrical Course—two courses for the price of one. Coupon brings particulars.

GET STARTED NOW—MAIL COUPON

I will send you a valuable book, entitled "How to Become an Electrical Expert," and full particulars of my free outfit if you will send this coupon now.

**L. L. COOKE, Chief Engineer,
CHICAGO ENGINEERING WORKS**
Dept. 66-C 2150 Lawrence Ave.
CHICAGO, U. S. A.

CHIEF ENGINEER COOKE
Chicago Engineering Works
Dep't. 66-C. 2150 Lawrence Ave., CHICAGO, ILL.

Dear Sir: You may send me entirely free and fully prepaid, a copy of your book, "How to Become an Electrical Expert," and particulars about your Home Study Courses in Electricity and Radio.

Name

Address

City..... State.....

meters, respectively. In this way each loud talker would have only to reproduce the music from one, or possibly not more than two or three different instruments, so that a much clearer and louder reproduction would result.

This idea is given for what it is worth, and no doubt there are a number of different ways in which this scheme may be carried out. By utilizing special carrier wave combinations and suitably super-imposing the voice on these waves, it will come to pass no doubt, that all of the different tone waves so to speak, can be transmitted from a single antenna. By a suitably worked out compound tuning scheme at the receiving station, all the different tone waves may be weeded out and directed into their respective loud talkers. Once the wave-lengths to be used are decided upon, the tuning of the transmitting and receiving sets can be simplified by gearing or linking the several condensers and inductances together, so as to be operated by a single handle.

The World's Largest Radio Horn

(Continued from page 245)

influence of radio on the world's work and play which warrants attention.

To the radio expert, however, the most interesting aspect of the situation is the fact that, through the use of its electro-dynamic reproducer, such true tones have been produced as to eliminate "distortion" even when employing this tremendous horn.

Four Principles for Care of Radio Storage Batteries

(Continued from page 255)

on the cell actually being tested. The plug on this cell should be replaced before the next one is removed. If this is done, there will be no accidental exchange of solution from one cell to another.

When all cells are in good order, the specific gravity of the electrolyte will test about the same (within 20 points) in each of them. Gravity at 1.235 to 1.250 indicates a fully discharged battery, which should not be used without recharging. If, after having a battery fully charged, it soon runs down again there is undoubtedly something wrong with the wiring system.

When the gravity is markedly lower in one cell than the other, especially after successive readings show the difficulties to be increasing, it is probable that the low cell is not in good order. If there is no leak in the jar and if the gravity has dropped 50 to 75 points below that of the other cells, a partial short circuit or broken insulation within the cell is indicated. Either of these may cause serious injury to the battery and should receive the prompt attention of a good battery repair man.

U.S. PATENTS



SEND FOR THIS FORM

Don't Lose Your Rights

Before disclosing your invention to anyone send for blank form "Evidence of Conception" to be signed and witnessed. A sample form together with printed instructions will show you just how to work up your evidence and establish your rights before filing application for patent. As registered patent attorneys we represent hundreds of inventors all over the U. S. and Canada in the advancement of inventions. Our schedule of fees will be found reasonable. The form "Evidence of Conception" sample, instructions relating to obtaining of patent, and schedule of fees sent upon request. Ask for them—a post card will do.



270 OURAY BLDG.,
WASHINGTON, D. C.

"Originators of form Evidence of Conception"

RADIO

And Other Electrical Inventions Patented

Mason, Fenwick & Lawrence PATENT LAWYERS

Washington, D. C. Established 1861

We have with us four late members of the examining corps of the United States Patent Office. Other offices: New York, Chicago, Denver, Seattle. Trade marks registered in United States and foreign countries

PATENTS

C. L. PARKER
Formerly Member
Examining Corps,
U. S. Patent Office.
PATENT - LAWYER
McGill Bldg., Wash., D. C.

Patents, Trade Marks, Copyrights, Patent Litigation
Handbook for Inventors, "Protecting, Exploiting and Selling Inventions," sent upon request.



Solder Your Connections

for best results. Get the "Wonder" a Self Heating Iron. Use it anywhere without stove. No workshop complete without it. Cheap to operate. Generates own vapor in two minutes. Absolutely safe. So simple a child can operate. Nothing to get out of order. Use it as blow torch also. Boxed complete with solder, Soldering and full soldering directions. Send \$2.00 cash or money order. Shipped prepaid anywhere in the U. S. Send order now.

Dealers—a big seller, write for proposition.

North Shore Radio Works, Dept. C-594
810 Davis Street, Evanston, Ill.

PATENTS If You Have an Invention and Desire to Learn How to Secure a Patent

Send for our Free Guide Book, HOW TO GET YOUR PATENT. Tells our terms and methods. Send model or sketch and description of your invention and we will give our opinion as to patentable nature. Our documentary

PROOF OF INVENTION

is intended for your protection and will be sent you without charge. Write for it.

RANDOLPH & CO.
Dept. 359 Washington, D. C.

NAME.....

STREET.....

CITY..... STATE.....

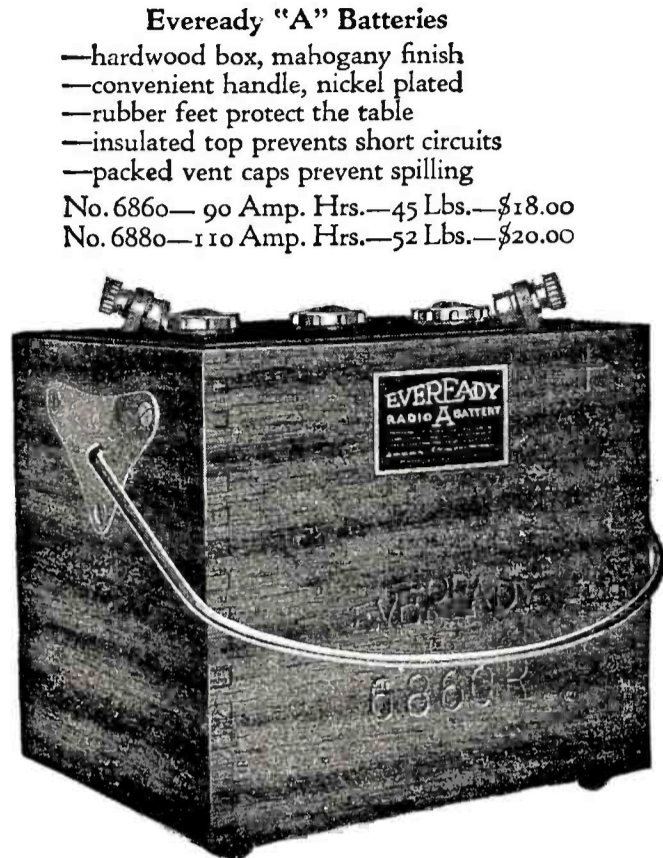
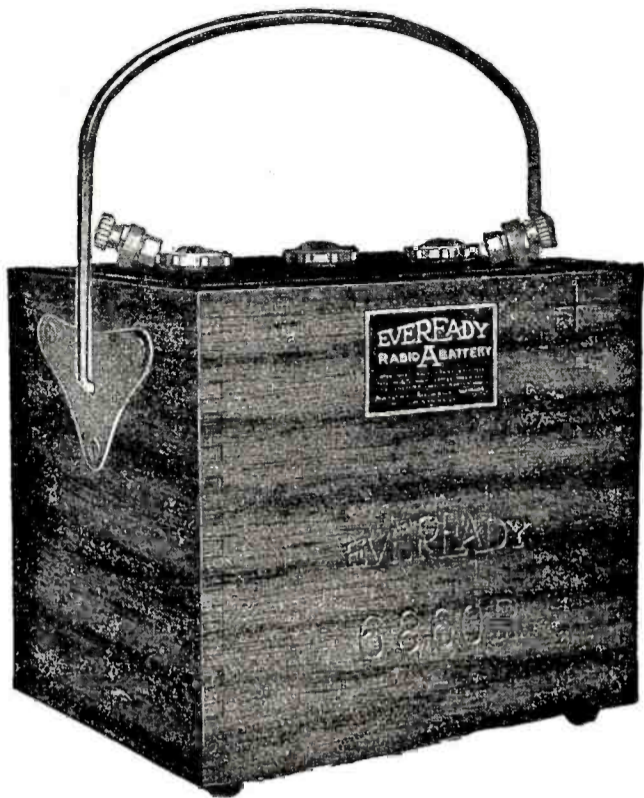

Eveready "A" Batteries
 —hardwood box, mahogany finish
 —convenient handle, nickel plated
 —rubber feet protect the table
 —insulated top prevents short circuits
 —packed vent caps prevent spilling
 No. 6860— 90 Amp. Hrs.—45 Lbs.—\$18.00
 No. 6880—110 Amp. Hrs.—52 Lbs.—\$20.00

Eveready "B" Battery No. 766
 Equipped with 5 positive voltage taps ranging from 16½ to 22½ volts. Fahnestock Spring Clip Binding Posts—an exclusive Eveready feature. Price \$3.00



Eveready "B" Battery No. 774
 Equipped with 6 positive voltage taps at 4½ volt intervals ranging from 18 to 43 volts. Fahnestock Spring Clip Binding Posts—an exclusive Eveready feature. Price \$5.00



For Better Results

USE

EVEREADY

"A" and "B" BATTERIES

with your radio set

For sale by the better radio supply dealers everywhere

Send today for descriptive booklets

NATIONAL CARBON COMPANY, Inc., Long Island City, N. Y.

Atlanta

Chicago

Cleveland

Kansas City

San Francisco



American Electric
HIGH GRADE
HEAD SETS
Army and Navy Type:
2500 OHM, PER PAIR, \$10.00
3200 OHM, PER PAIR, 12.00
Swedish-American Type:
2200 OHM, PER PAIR, . 8.00
American Electric
COMPANY
CHICAGO

BANGERT ELECTRIC CO., Inc.
Headquarters for
RELIABLE
RADIO RECEIVING SETS
SUPPLIES and PARTS

THREE STORES
297 Fulton St., JAMAICA, N. Y.
27 Main St., HEMPSTEAD, L. I.
16 W. Merrick Rd., FREEPORT, L. I.

MANUFACTURERS OF
TESTED, MOUNTED, GUARANTEED
CRYSTALS
WRITE FOR DISCOUNTS

WANTED!
ADDITIONAL LIVE AGENTS AND DEALERS
TO ADD MORE NAMES TO THE
500,000 Persons Who Have Enjoyed the Won-
derfully Illustrated Book

the
A.B.C. of RADIO
25c.

At All Stores and Newsstands or from the Publisher
MARTIN H. RAY, 165 Broadway, New York
Free Advice as to Equipment Given Purchasers of Book

The mere fact that the "A" battery continues to heat the filament of the vacuum tubes is no indication whatever that it is fully charged, or conversely that it is not approaching the state of total discharge. The "A" battery may continue to function normally right up to the point where it may be totally beyond repair. One can not expect the light of the tube to show signs of weakening with discharge of the "A" battery because the battery may be becoming dangerously low and still heat the filaments satisfactorily. However, a discharging battery will be noted by the fact that less of the rheostat resistance is used than normally, showing that less voltage is being delivered to the filament circuit.

FORTY NEW BROADCASTING STATIONS LICENSED

- WCAZ—Robt. E. Compton & Co., Quincy Whig Journal, Quincy, Ill.
- KDZV—Cope & Cornwell Co., Salt Lake City, Utah.
- WCAV—J. C. Dice Electric Co., Little Rock, Ark.
- WDAD—William Louis Harrison, Central Kansas Radio Supply, Lindsborn, Kansas.
- KDYU—Herald Publishing Co., Klamath Falls, Ore.
- WDAI—Hughes Electrical Corp., Syracuse, N. Y.
- WDAC—Illinois Watch Co., Springfield, Ill. (Weather only)
- WDAF—Kansas City Star, Kansas City, Mo.
- WCAY—Kesselmen O'Driscoll Co., Milwaukee, Wisc.
- WDAG—J. Laurence Martin, Amarillo, Texas.
- WDAK—Mine & Smelter Supply Co., El Paso, Texas.
- WAAD—Ohio Mechanics Institute, Cincinnati, Ohio.
- WCAW—Quincy Herald and Quincy Electric & Supply Co., Quincy, Ill.
- KDYW—Smith-Hughes & Co., Phoenix, Ariz.
- WDAB—M. C. Sumner & Son, Portsmouth, Ohio.
- WKB—Sweeney School Co., Kansas City, Mo.
- WDAE—Tampa Daily Times, Tampa, Fla.
- KDYS—The Tribune, Inc., Great Falls, Mont.
- WCAX—University of Vermont, Burlington, Va.
- WDAA—Ward-Belmont School, Nashville, Tenn.
- KDYY—Rocky Mt. Radio Corp., Denver, Colo.
- WDAJ—Atlanta & West Point R. R. Co., College Park, Ga.
- WCAR—Alamo Radio Electric Co., San Antonio, Texas.
- KDYO—Carlson & Simpson, San Diego, Calif.
- WCAP—Central Radio Service, Decatur, Ill.
- WCAK—Alfred P. Daniel, Houston, Texas.
- KDYN—Great-Western Radio Corporation, Redwood City, Calif.
- WCAJ—Nebraska Wesleyan University, Lincoln, Nebr.
- KDYQ—Oregon Institute of Technology, Portland, Ore. (Weather only)
- WOC—Palmer School of Chiropractic, Davenport, Iowa.
- KDYR—Pasadena Star-News Publishing Co., Pasadena, Calif.
- WCAU—Philadelphia Radiophone Co., Philadelphia, Pa.
- WCAL—St. Olaf College, Northfield, Minn.
- WCAO—Sanders & Stayman Co., Baltimore, Md.
- KDYM—Savoy Theatre, San Diego, Calif.
- WCAN—Southeastern Radio Telephone Co., Jacksonville, Fla.
- WCAT—South Dakota School of Mines, Rapid City, S. D. (Weather only)

RADIO CENTER
OF
New York City
If you cannot secure your Radio needs here, you will not find them anywhere.
Complete Line of Amrad and Federal Sets and Accessories.
The Largest and Most Varied Stock of Radio Material in Greater New York.
VERIFY OUR STATEMENT
MAIL ORDERS FILLED.
ELECTRIC SERVICE ENGINEERING CO.
105 West 47th Street
New York City

Complete Receiving Set for \$20.00
Material mounted on panel but unwired. Hook up yourself. Book of wiring diagrams furnished with each set.
Set consists of
1 Hard Rubber Panel 7 x 21"
3 " " Dials 3"
2 Variometers
1 Variocoupler
2 Inductance Switches
1 Socket
1 Rheostat
1 Comb. Grid Leak Condenser
1 Phone Jack
Wire, Tubing, Terminals, etc.
The above, combined with two-step amplifier, \$35.00, unwired.
Send for price list of our complete line.
C & K RADIO MFG. CO.
316 FIFTH AVE. BROOKLYN, N. Y.



LOOSE COUPLER
Wood Parts ^{As above} _{by mail} 75c
End plates to fit 4 in. tube. Plugs 801 and 601 to fit 3 1/2 in. tube. 18 in. Base. Made of high grade ply wood. *Dealers and Jobbers write for discount.*
DETROIT WOODENWARE CO.
Elmwood and Chestnut, DETROIT

NENCO "B" BATTERIES
LAST LONGER
SERVE BETTER
COST LESS

For amplifying tubes, detector and plate circuit. Nenco "B" Batteries give more hours of service, are moisture proof, silent and free from leaks.

DEALERS
Write for Special offer and discount
National Electric Novelty Co.
53 Walker Street NEW YORK

JORGOTONE RECEIVING SETS
IDEAL SETS FOR "VACATION LAND"
Send for Bulletin RN
JOHN JORGENSEN COMPANY, INC.
120 LIBERTY STREET NEW YORK

A Wonderful Achievement!

PATENTED

Sept. 4, 1917; Oct. 12, 1920; Pat. Pend.
Jan. 21, 1908; Sept. 7, 1909; Nov. 24, 1914
Nov. 17, 1908; July 21, 1914; April 27, 1915
June 15, 1909; Sept. 8, 1914; Jan. 23, 1917

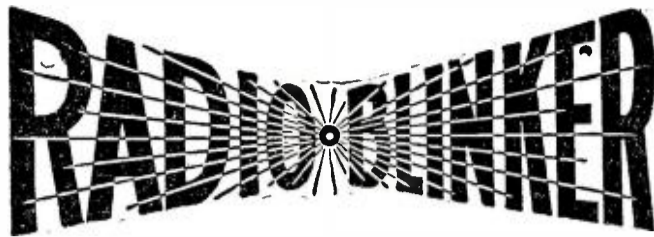

Licensed for amateur, experimental or entertainment purposes only. Any other use will constitute infringement.

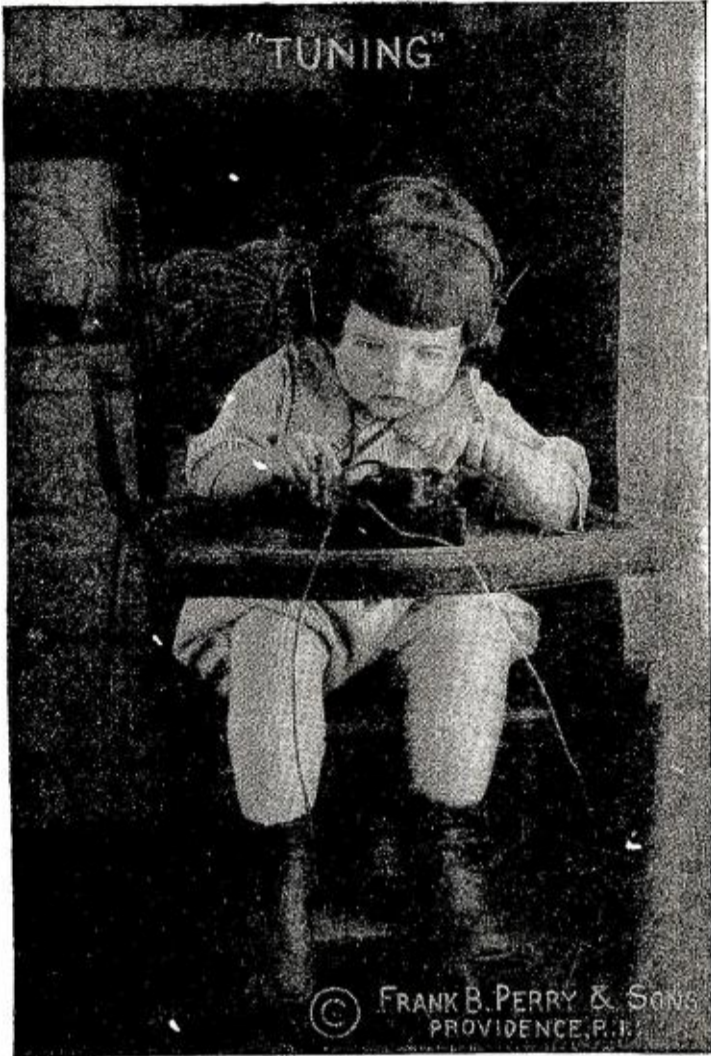

So Simple a Child May Operate It!

RECEIVING SET
The smallest practical receiving set manufactured

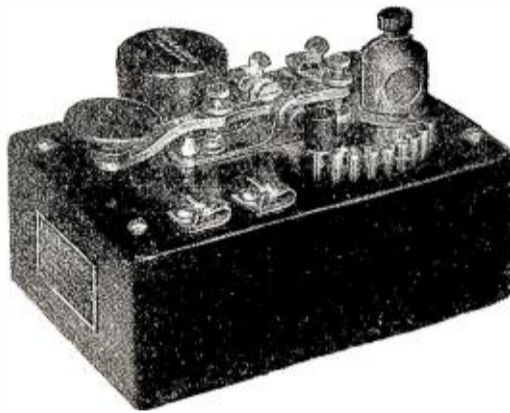

Size, 5 $\frac{1}{8}$ " x 3 $\frac{1}{2}$ " x 3 $\frac{1}{2}$ "—Net Weight, 1 lb.

THE THREE IN ONE SET

- (1) A practical, efficient, self-contained Wireless Receiving Set for Radio Phone Broadcasting and Commercial Stations approximately 150 to 800 meters wave length.
A newly designed dustproof crystal detector, extremely sensitive. Can be quickly adjusted by means of buzzer test and locked in position.
- (2) A miniature Sending Set within limits of buzzer radiation.
- (3) A Practice Set for code work.
Ready for phones, aerial and ground connections.
Sold on merit with our usual guarantee.



Real Results With the Radio Blinker Receiving Set!

TEL. BAY BAY
5964

**EASTERN
RADIO
INSTITUTE**

899 Boylston St.
Boston, Mass. May 23, 1922
RADIO DEPARTMENT

Equipment No. 1

- 1 Radio Blinker Receiving Set
- 1 Pair Western Electric Co. Head Phones of best quality.

Equipment No. 2

- 1 Radio Blinker Receiving Set
- 2 Pair Murdock 3000 ohm Head Phones.
- 150' Antenna Wire.

Frank B. Perry & Sons,
513 Hospital Trust Bldg.,
Providence, R. I.

Gentlemen;

After giving your Radio Blinker Receiving Set a very rigid test here at the Institute we take pleasure in writing you concerning the results that we obtained during this test.

The outstanding feature of your receiving set is the simplified adjustment of the crystal detector which we found very sensitive on all signals.

Moreover the purchaser of this crystal receiver is obtaining a combined receiving and buzzer practice set which is excellent for one to learn the code on.

Wishing you success with your little set, we are,

Very truly yours,

EASTERN RADIO INSTITUTE

A. D. Moulton

adm/m

Superintendent

Price, for either equipment as above, \$25.00. Ask your nearest dealer and if he cannot supply you write us for further information.

Manufactured Solely by

Frank B. Perry & Sons
Providence, R. I.

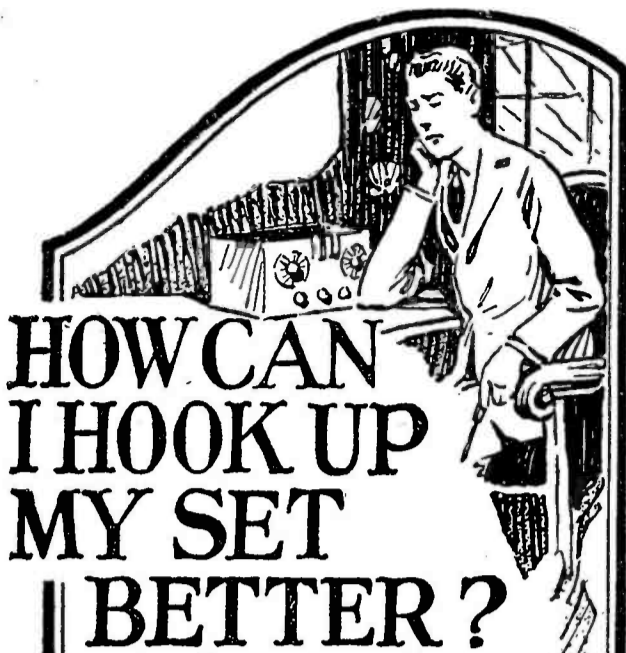

HOW CAN I HOOK UP MY SET BETTER?

Is there some change I can make that will get me the distances others are getting? How can I get sharper tuning with my present outfit? Is there some source of information about the newest hookups, the latest developments, improved types of aerial, that is really dependable and *never grows old*? Yes



just out, is the first real authority on all radio questions. It is the one source of radio information that is *not* opinions, *not* hearsay, but tells authentic facts!

Its authors are Dr. J. H. Dellinger, Chief of the Radio Laboratory of the United States Bureau of Standards and L. E. Whittemore, Alternate Chief.

Lefax knows all—tells how. It gives the latest hookups, wiring-diagrams, the exact function of every piece of apparatus, both receiving and transmitting. It is technically correct in every day language. It gets right down to brass tacks with information that will help you duplicate the results that experts attain.

Always new

Lefax (leaf facts) Radio Handbook is loose leaf.

It never grows old. All the newest developments will be covered *as soon as they happen* on a series of new sheets, sent FREE to every owner up till July 1st, 1923.

The price is \$3.50 in a handsome six-ring binder. Considering the time, trouble and money Lefax will save you—the results it will help you get—the satisfaction of having the cream of radio research always at your finger tips—Lefax is the best radio investment you could possibly make. Get your copy from one of the 300 Lefax agencies or from your regular radio dealer. If he does not know about Lefax yet, order your copy through him or send us \$3.50 direct and your handbook will be sent postpaid. But be sure to get *your* handbook at once for a full year of Lefax service FREE.

LEFAX, INC.

151B South Ninth Street
PHILADELPHIA, PA.

Publishers of loose leaf handbooks on scores of scientific and technical subjects which are used as authorities by engineers, scientists, universities and technical schools throughout the country.



\$3.50

WCAQ—Tri-State Radio Mfg. and Supply Co., Defiance, Ohio.
WCAM—Villanova College, Villanova, Pa.
WCAS—William Hood Durwoody Industrial Institute, Minneapolis, Minn.

Radio Digest

(Continued from page 237)

phone broadcasting, and to insure the maximum and practical use of the ether by assigning wave-lengths for specific purposes, a bill is in course of preparation.

Following the recommendations of the Radio Committee which assembled at the call of Secretary Hoover, the final report was circulated in the Departments of War, Navy and Commerce, and it is understood, has received the approval of these agencies.

A special committee composed of Senator F. B. Kellogg, Representative W. H. White, Jr., W. D. Terrill, Chief Radio Inspector, Department of Commerce and Mr. A. J. Tyrer, Deputy Commissioner of Navigation, Department of Commerce, met recently to go over the final draft of a proposed bill which Congressman White will shortly introduce in the House of Representatives. Present plans in Congress aim to push this needed legislation so that it will be enacted during the present session.

TRANSMITTING STATIONS TOTAL 19,067

A survey of all radio transmitting stations licensed by the Department of Commerce shows that there are today 19,067 stations. Of this number 15,495 are amateur stations, 348 experimental and technical training schools, 2,783 American ships and the balance, 439, commercial stations.

Of this last number there are today 274 broadcasting stations, known as limited commercial stations, 20 of which were licensed recently. They comprise universities, municipalities, newspapers, electrical manufacturers and retail stores, sending entertainment or information on weather, crops and market reports.

The growth of this class of radio stations has been remarkable; it jumped from 67 stations a little over two months ago to 274 today. Applications are filed on an average of about three or four a day.

TRANSMITTING STATIONS

Trans-Oceanic	11
General Public or "ship to shore"	31
Point to Point	124
Broadcasting	274
American ships	2,783
Experimental	225
Technical and Training Schools	123
Amateur	15,294
Special Amateur	201

AMATEURS BY DISTRICTS

1. Boston	2,490
2. New York	2,313
3. Baltimore	1,831
4. Balti (Savannah)	319
5. New Orleans	699
6. San Francisco	1,616
7. Seattle	726
8. Detroit	2,393
9. Chicago	2,907

The Commerce Department does not regulate or record receiving stations, and will not guess at the total number, now unofficially estimated at about a million and a half.

ELIMINATING STATIC

Plans for the perfection of the "Resonance Wave Coil Method" recently demonstrated in Chicago as a static eliminator in radio receiving, and the design of a standard instrument for general use, are being worked out, it was announced by Dr. Louis Cohen, Consulting Engineer of the War Department, recently.

PHONOTACH

Makes Your Phonograph a Radio Loud Speaker

(Trade Mark)
Adjust it in a minute.

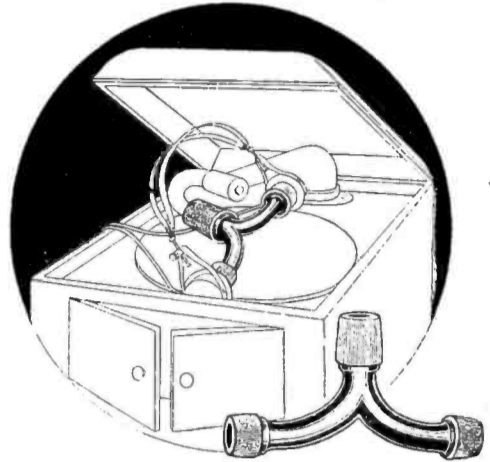

Patent applied for.

A New and Better Loud Speaker
at a very low cost

The PHONOTACH connects the receivers with the tone arm of your phonograph.

Utilizes the scientifically designed tone amplifier of the talking machine to secure mellowness and beauty of tone.

Price - \$3.00

Send for one today—At your dealer, or by mail.

W. A. MILLS,
103 Park Ave., New York, N. Y.

IMMEDIATE DELIVERIES TO CONSUMERS

Dreyfuss 'Phones

(CONCERT TYPE)

PRICE \$8.00

Complete Crystal Receiving Sets

- 1 pair Dreyfuss 'phones
- 100 feet aerial wire
- 2 insulators 1 ground clamp

PRICE, \$14.00

P. M. DREYFUSS

FOURTH FLOOR
150 CHAMBERS ST., N. Y. C.

Radio Cabinets and Battery Boxes

Wholesale ONLY

SHEIP & VANDEGRIFT, Inc.

814-32 N. Lawrence St.
PHILADELPHIA, PA.

CONNECTICUT RADIO EQUIPMENT

Variable Condensers, Transmitters, Head Bands, Panel Switches, Etc.

Connecticut Tel. & Elec. Co., Meriden, Conn.

—throw 'em away!

Whether you have a thousand dollar set or one made from cardboard tubes, if you want to increase its efficiency on out-of-town concerts very greatly—sell, give away or throw away your old style Rheostat and get one of the new "WORKRITE" Rheostats. You will be greatly surprised at the difference.

NEW "WORKRITE" SUPER RHEOSTAT

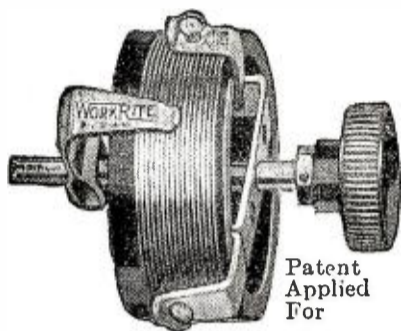

Patent Applied For

Here is a REAL Rheostat—something entirely new and very much needed. Can be instantly changed from 6½ ohms resistance to zero

by simply pushing in the knob, or you can have fifty thousand different adjustments by turning the knob. Any radio man can appreciate what this means on a detector tube when working on DX signals or concerts. Many engineers claim the WorkRite Rheostat will double the efficiency of the set. All metal parts made from brass, nicked and highly polished. The special resistance wire is non-corrosive, non-rusting and does not change in resistance through change in temperature. Screws for mounting on panel furnished. The WorkRite Rheostat is really remarkable in its performance and is easily worth twice the price asked. No set should be without it. Price...\$1.50

Type "A" WorkRite Hydrometer

Double the life of your battery by giving it proper care. Fill and test it regularly with a WorkRite Hydrometer. Never let it become discharged below 1150, or it will soon be ruined. Full instructions for testing and care of battery with each "WORKRITE." Get one now! PRICE\$1.00



RADIO FANS: Insist that your dealer furnishes genuine WorkRite Parts. Accept no substitutes!
JOBBERs and DEALERS: Write or wire for discounts.

ANNOUNCING NEW (LOWER) PRICES

WorkRite Super Variometer

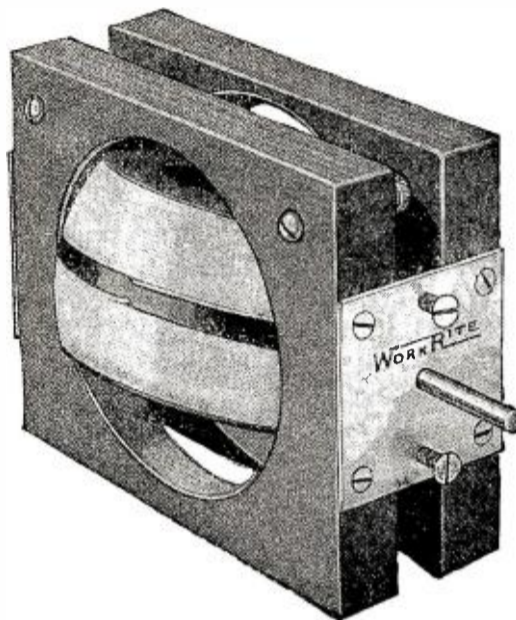

The WORKRITE VARIOMETER is made from finest quality mahogany and will not warp. Beautiful finish. Binding posts are placed between stators. Both connections made by double spring contacts. Has 3/16" shaft. All windings are perfectly made, and connections cleverly concealed. Easy to mount on panel with two screws furnished. All metal parts made from brass, highly polished and nicked. Substantially built throughout. Just the right number of turns and air space to make it very sensitive and to tune extremely sharp. WORKRITE VARIOMETER packed in attractive box.....\$5.25 With Dial..... 6.00

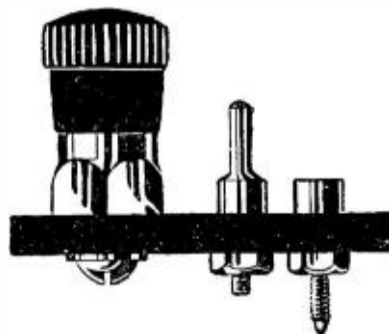

WorkRite Binding Posts.....10c
WorkRite Switch Points..... 3c
WorkRite Switch Stops..... 4c
WorkRite Switch Lever with Bushing40c

WorkRite 180° Super Variocoupler

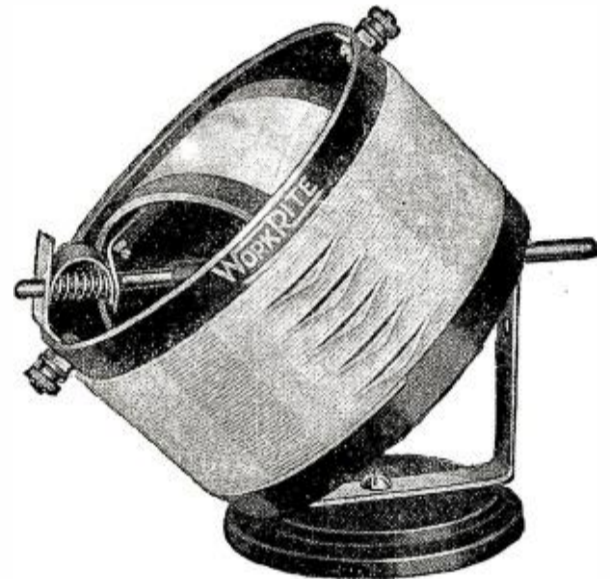

The WORKRITE VARIOCOUPLER represents perfection in getting all dimensions and number of wire turns just right. Tunes twice as sharp as the ordinary 90° coupler. Most any coupler will work, but few will "WorkRite." Both primary and secondary are made from Formica. Contacts are formed by double springs, eliminating scratching noises. All metal parts are made from highly polished brass and nicked. Shaft 3/16". Easy to mount on panel. Leading radio engineers have pronounced WorkRite Variometers and Couplers the best they have ever tested. WORKRITE VARIOCOUPLER packed in attractive box.....\$5.00 With Dial..... 5.75

WorkRite Switch Set

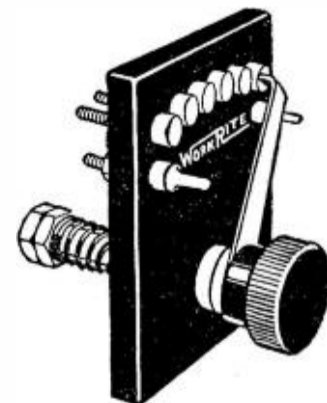

Just what you want! Remove parts and use the block for a template in drilling panel. Switch Arm and Points made to work together. Put up in neat individual boxes. Easy to sell.

PRICE, COMPLETE.....80c

THE WORKRITE MFG. CO.,

5519 EUCLID AVENUE,
CLEVELAND, OHIO
Branch, 2204 Michigan Ave., Chicago, Ill.

HOMCHARGE YOUR BATTERY for A Nickel



No muss, trouble, dirt—no moving of batteries—loss of time—no effort on your part—no technician or professional knowledge needed.

THE HOMCHARGER

successfully meets all charging conditions, and is the only rectifier combining the following essential Hom-charging features.

1. Self-polarizing. Connect battery either way and it will always charge. No danger of reverse charging, ruined battery or burnt-out rectifier.
2. No delicate bulbs to break or burn out. Only one moving and two wearing parts. These are replaceable as a unit, after thousands of hours' use, at small cost. Cannot be injured by rough handling.
3. Operation stops and consumption of current ceases immediately upon disconnecting battery.
4. The only charger costing less than \$100.00 that will fully charge a battery over night. Gives battery a taper charge—exactly as recommended by battery manufacturers. Guaranteed not to harm your battery even though left connected indefinitely.
5. Highest efficiency of any three or six cell charger made.
6. No danger of fire. Approved by the Underwriters.

ATTENTION MOTORISTS

Will charge your auto battery as well as radio battery. Send for Bulletin No. 58 for further information. For sale by all radio, electrical and accessory dealers or shipped, express prepaid, for purchase price\$18.50
\$20 West of the Rockies



**THE AUTOMATIC ELECTRICAL
DEVICES CO.**
116 West Third St. CINCINNATI, OHIO
BRANCH OFFICES—New York, Chicago, Pittsburgh,
Los Angeles, New Orleans, Detroit, Philadelphia,
Baltimore, Dallas.

At present this instrument is only in the form of special laboratory apparatus, Dr. Cohen pointed out and as such was demonstrated by him and Major J. Mauborgue, Chief Signal Officer of the 6th Army Corps Area in Chicago.

At the suggestion of Major General Geo. O. Squier, Chief Signal Officer of the Army, who invented "wired wireless" and a method of broadcasting by that means on the lines of electrical power companies, Dr. Cohen and Major Mauborgue, undertook a study of combining their developments in the use of "Resonance Wave Coils" with line-wire broadcasting, with the result that they found a means of eliminating a large amount of the static ordinarily encountered. For some time Major Mauborgue and Dr. Cohen have been experimenting with their resonance coils method used in the reception and transmission of radio signals, and upon combining the theories of General Squier with their own, were able to get most satisfactory results in eliminating static interference. A number of patents have already been filed on circuit arrangements for use with wave coils by these experts.

Commenting on the recent experiments in Chicago, Dr. Cohen said that two important things were accomplished: First, they broadcasted by means of "wired wireless" on the mains of the Edison Company in the city of Chicago, plugging in a transmitter on the line through condensers and sending with a 50-watt lamp. The messages transmitted were received at one point on the circuit six miles away from the transmitting station and at another point twelve miles distant. This was the first time that a practical demonstration of General Squier's line broadcasting system had been given in public.

Second: messages were also received from a distance on the Edison system, it was said, showing that besides the signals put on the circuit messages sent from a distance could be received, the city lighting circuit serving in the place of an aerial. During the demonstration signals from Government transmitting stations in Washington were picked up and heard clearly, the Chicago city electrical system acting as a huge receiving antenna.

In receiving by this method, Dr. Cohen pointed out, the interference of static is less, although much static is still present, but by connecting in the resonance coils in combination with certain circuit arrangements perfected by him and Major Mauborgue, it was found that the static was practically all eliminated. The resonance wave coil method, he added, had also been found applicable for use as an ordinary aerial, through experiments conducted last summer.

Describing the device, known as resonance wave coils, briefly, Dr. Cohen said that it was practically a long coil, the length of the wire being comparable to the length of the wave which is being received. The coil which stands vertical is enclosed with short metal tubes which slide up and down the coil, and are grounded through certain circuit arrangements which act like a drain for the static currents but permit the signals desired to be received to pass through to the detecting instrument. The device can be used either with a lighting circuit used as a receiving antenna as described by General Squier, or in connection with a regular receiving aerial.

A great future is seen by experts for the recently developed static eliminator, as by grounding the noisy static, which has interfered with the reception of radio signals for years, particularly in the summer, the incoming signals are left clear and distinct.

A THOUGHT OF THE DAY

It would be nice if they would build radiators, each fitted with a binding post.

By A. J. DeLong

DREYFUSS PHONES

(Concert type)

\$8.00 Per Pair List Price



Dreyfuss Phones are considered the Best Phones for Radio Telephony work.

Designed by Telephony Engineers of over 18 years experience

Distributors:—Get in touch with us for open territories

P. M. DREYFUSS CO., Inc.
150-152 Chambers St. New York, N. Y.

2000 OHMS

We are **NOW** Making Delivery

RADIO DETECTORS

Size 3 1/2 x 2"

An improved detector of real merit. Nickel-plated posts.

Price 75 cents, post paid

Dealers get our prices on Panel Switches and Binding Posts.

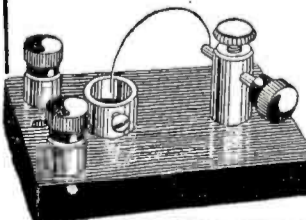

SYPPER MFG. CO.
Dept. R., TOLEDO, OHIO

SPECIAL OFFER TO DEALERS

Write for
Special Price List on

3-INCH DIALS, RHEOSTATS
TRIPLE COIL MOUNTINGS
COMPLETE RADIO OUTFITS

Immediate Delivery



NEW YORK RADIOPHONE CO.
32 UNION SQ. - NEW YORK CITY



The Recognized Symbol of Superior Performance

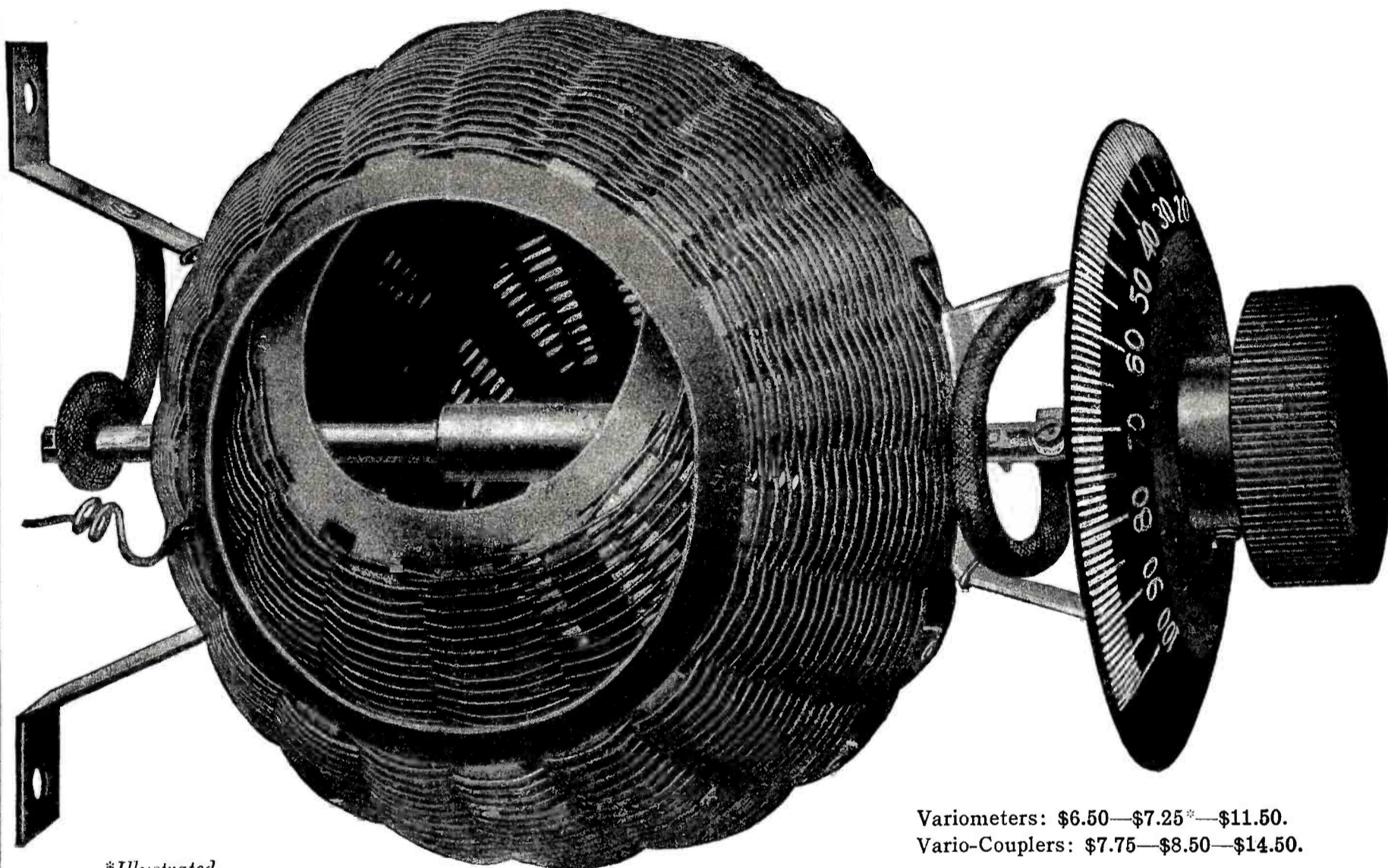

**Illustrated*

Variometers: \$6.50—\$7.25*—\$11.50.
Vario-Couplers: \$7.75—\$8.50—\$14.50.

Amrad BASKETBALL Variometer

There are six styles of Amrad Variometers and Vario-Couplers—each a BASKETBALL. The unique method of winding, high electrical efficiency, trim appearance, lightness and rigidity have won for BASKETBALLS an enviable reputation.

BASKETBALLS are used exclusively in all Amrad tuning units—one of the reasons for the enormous demand for Amrad products. Quite naturally the BASKETBALL is the vital element around which is built the new Amrad Crystal Receiver, 2575, the Beginner's Receiving Set de Luxe described in Bulletin M mailed free.

Ask your dealer to show you BASKETBALLS and insist on the exclusive Amrad Basket Weave. If your dealer does not stock, place your order with him and he will secure it quickly. Look for the green and yellow Amrad labels in the better stores.

Bulletin O, mailed free on request, describes the Amrad BASKETBALL. Complete catalog, including Receiving Sets, Units and Parts, 10 cents in stamps.

Amrad BASKETBALL Variometer was awarded the New York Evening Mail Radio Institute Certificate of Excellence, May 20, 1922.

AMERICAN RADIO AND RESEARCH CORPORATION

General Office, Factory and Laboratory

New York District Office
21 Park Row

203 College Avenue, Medford Hillside, Mass.
(SUBURB OF BOSTON)

Chicago District Office
220 So. State St.

WHERE HISTORY COUNTS

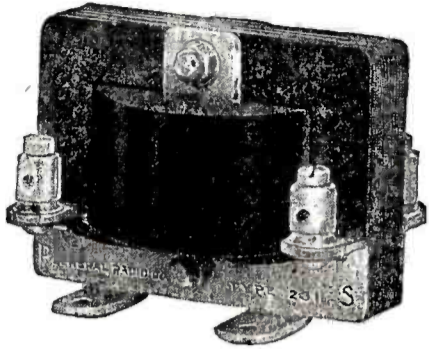

TYPE 231A

Amplifying Transformer

One of our quality instruments that has stood the test of time

Price \$5.00

THE spread of radio enthusiasm over the country has brought in its wake a host of new companies and instruments. Radio products of all kinds and qualities are flooding the market. The new purchaser not being familiar with the names of the old established radio companies has little to guide him in his choice.

We, accordingly, ask you to weigh the fact that the General Radio Company was one of the earliest manufacturers in the field of high-grade radio instruments. It has for years maintained a research laboratory for the development of new apparatus. Our instruments are in daily use at the Bureau of Standards radio laboratory, the radio laboratories of the Army and Navy, the principal college and commercial research laboratories throughout the country, as well as by thousands of citizen radio enthusiasts.

We have not allowed the enormously increased demand to cause us to discard our rigid inspection system or to lay aside our development work. We have a reputation to maintain.

When you purchase radio instruments, we ask you to give consideration to these facts. Every instrument we make is guaranteed. When you think of Radio, think of GENERAL RADIO.

Send for Free Radio Bulletin 911-N

GENERAL RADIO COMPANY

MASSACHUSETTS AVENUE AND WINDSOR STREET
CAMBRIDGE 39 MASSACHUSETTS

Standardize on General Radio Equipment Throughout
CARRIED BY LEADING DEALERS

ASK FOR A "PRAMCO" UNIT

TRADE MARK

Includes All Necessary Panel Mountings for a Complete Crystal Receiver

CONTENTS

- | | |
|--|---------------------------------------|
| 18 Switch Points with Nut | 2 Small Posts for Telephone Receivers |
| 4 Switch Stops with Nut | 2 Switch Levers, 1 1/2" Radius |
| 1 Detector Post, Universal Joint | 1 Crystal Cup |
| 2 Large Binding Posts for Antenna and Ground | 1 Phosphor Bronze Cat Whisker |

All Parts Polished and Nickel-Plated with Our Unequaled Finish.

Put Up in a Box Complete for **\$2.00**

From Your Dealer or Direct Postpaid

PREMIER DENTAL MFG. CO.

Switch Points, Switch Levers, Binding Posts, Crystal Cups, Detectors, Etc.

Our New Literature Now Ready for Dealers

1900 North Sixth Street Philadelphia, Pa.

Electrical men with training are in demand. For more than a quarter of a century, this school has been training men of ambition and limited time, for the electrical industries. Condensed course in Electrical

Engineering enables graduates to secure good positions and promotions. Theoretical and Practical Electricity, Mathematics, Steam and Gas Engines and Mechanical Drawing. Students construct dynamos, install wiring and test electrical machinery. Course with diploma complete

In One Year

Over 3000 men trained. Thoroughly equipped fireproof dormitories, dining hall, laboratories, shops. Free catalog. 30th year begins Sept. 27, 1922.

BLISS ELECTRICAL SCHOOL
407 Takoma Ave., Washington, D. C.

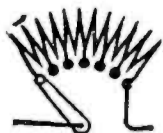

Our new receiving sets are out this month. The ideal set for the beginner at an attractive price.

The CONCERTINA \$45.00

We rewind your phones to any ohmage.
With No. 40 wire, per phone.....\$1.25
With No. 44 wire, per phone..... 1.50

The Ridgewood Radio Shop
1603 Myrtle Ave. RIDGEWOOD, L. I.

COLUMBUS MAYOR STARTS SOMETHING

There are thousands of "Radio Bugs" in Columbus, Ohio, and about as many broadcasting stations. When all of these stations are in operation the air somewhat resembles a bowl of spaghetti, the real spaghetti being the beautiful music broadcasted by the larger stations and the seasoning which all term as bad, some amateur talking to a neighbor.

Everyone was disgusted, so the noble Mayor of Columbus, Ohio, James J. Thomas, who is a great radio fan, started something. He appointed what is believed to be the first Municipal Radio Committee in the United States. The committee is composed of: Roy A. Brown, of the Ohio State University department of electrical engineering, as chairman; Perry Okey, M. Fay McDowell and Claud Bauden and Max Reiser as other members. These men are vitally interested in the radio activities of the city as well as being experts in the various ways and means of putting over any undertaking they wish to promote.

The principal work of this committee as outlined by the Mayor will be to co-operate with and regulate the radio-telephony and wireless-telegraphy enterprises of Columbus amateurs so that abuses will be eliminated as far as possible. As yet the committee has no definite plans, but every effort is being made to establish a co-operative spirit among the amateurs as a first step, and then to make a definite set of rulings governing local broadcasting.

The outgrowth of this committee, the Mayor pointed out in his letter of appointment, is the installation of a city broadcasting station to be used as medium to broadcast police bulletins giving the descriptions of criminals and the occurrences of crimes to various other cities. The Mayor has already received the use of the broadcasting station of a local supply company tentative to the installation of the city broadcasting station.

RECEIVING ON STEAM RADIATORS AND PIPE LINES

The latest scheme for receiving radio messages involves the use of a good steam radiator, or a hot-water radiator, for that matter, according to a report reaching the radio section of the Army. This system, said to have been evolved and tested out satisfactorily by a former electrical engineer of the Signal Corps, has evidently a market value, as the inventor is reported to have sold out his circuits and patents to a big corporation for a large sum of money.

Many curious forms of receiving apparatus have already been used in lieu of the usual aerials, some of them with remarkable success by well-known experts. Among the unusual types of aerials employed are the "tree antenna" demonstrated some time ago by Major-General Squier; the bed-spring antenna used by several experimenters, a trough of water and a cake of ice employed in Signal Corps experiments a year ago, and smaller and more handy devices such as umbrellas and fish poles. But the latest device for this purpose should interest many fans as it is so readily available and should prove most useful, if practical.

A WEDDED WIDOW

I've been a widow all my life;
That is, since I have been a wife,
Communing with myself, the time,
In solitary pantomime.
Golf claimed him almost every day,
And, as he niblicked on his way,
I followed in his gallery
Or, on the club house porch, drank tea.
At night, bridge took him from my side;
I couldn't play it—though I tried;
But sat at home, with ill-content,
The while he gambled with the rent.
He gave up both. Said he: "I'm through;
I'll stay at home alone with you."
But Radio's got him. Fickle men!
And I'm a Widow once again.

—George Mitchell (Judge)



by any code
its ~~XX~~

The Radio Amateur who insists upon equipping his set perfectly will insist upon panelling it with the PROVED perfection of

bakelite-dilecto

for radio panels and
for absolute insulation

Proved by over eight years' use in the U. S. Navy and Signal Corps, and positively guaranteed highest in dielectric and tensile strength. (Dielectric constant 5.2—and equally superior in all other tests.) Proof against heat, water and milder acids; amazingly hard and strong; will never warp nor swell and is EASILY MACHINED. Tell us who your electric supply man is and we will tell you where to get Bakelite-Dilecto cut to your requirements.

Write us direct for information of the radio panelling material you certainly want if you want efficiency.

THE **Continental Fibre Company**
factory-Newark, Delaware

Dealers Serviced from

- NEW YORK—233 Broadway
- CHICAGO—332 So. Mich. Ave.
- SAN FRANCISCO—75 Fremont St.
- ROCHESTER—85 Plymouth Ave. S.
- PITTSBURGH—301 Fifth Ave.
- LOS ANGELES—411 So. Main St.
- SEATTLE—1927 First Ave. S.

MEMORIZE CONTINENTAL INSTANTLY
CODE ALMOST

TRADE MARK **BKUMA YRLSBUG** REG. AP. FOR

ATTENTIVE BEGINNERS WHO USE
DODGE ONE DOLLAR RADIO SHORT CUT
DO ARRIVE

WILLIAM M. ADLER 2BGC
 576 East 143d St., New York City
 Memorized Code in 40 Minutes
 Qualified for License After Two Weeks' Practice

J. ROBERT ZIEGLER 3A10
 129 Dauphin St., Lancaster, Pa.
 Memorized Code in 30 Minutes
 Qualified for License After One Week's Practice

INVESTIGATE—SAVE TIME AND EXPENSE—GET RESULTS
 Do not be satisfied with Radio Broadcasts by Govt., Manfrs., Press, etc.
MASTER CONTINENTAL CODE EASILY AND QUICKLY

and Understand Everything you may hear at any time from anywhere. Eventually add a sending set to your outfit. Get in touch with the World. Talk Back—Ask and Answer. To be unable to use Radio Code will soon be as inconvenient as present inability to read and write.

For Ten Red Stamps will mail Booklet containing information and Reports from 250 successfully self-instructed beginners located in 46 States and Territories who have reported Mastered Code in 30 Minutes. In 45 Minutes. In One Hour. In One Evening, etc. Many have installed stations and with little practice obtained license as Radio Operators.

Avoid Disappointment. Before purchasing any Code learning method demand evidence of successful use by beginner, also time required.

No instruments needed to learn the Code. Entire necessary expense One Dollar, and limited study of Dodge Short Cut.

C. K. DODGE Box 200 **MAMARONECK, N. Y.**

R. M. Sherrill's Station at Evanston, Ill.

(Continued from page 250)

The transmitter uses four 5-watt radio-trons—all as oscillators. The plates are supplied with 800 volts of rectified A.C. from an electrolytic rectifier. This plate supply is well filtered so that the radiated wave is very little modulated by the A.C. This transmitter makes use of the "grid-tickler" circuit, which I find works very well for I.C.W., buzzer-modulated C.W. and phone. The radiation on the I.C.W. varies from 3.6 to 4.1 thermo-couple amperes.

The main feature of the center panel is the control switch. This is a seven-pole affair, which is operated by the handle protruding from the center of the panel. When changing from receiving to sending, this one switch connects and disconnects everything that is necessary, and in the proper order.

Signals from this set have been reported from British Columbia and all of the Pacific Coast states, and from most of those on the Atlantic. The record distance worked is 6XAD at Avalon, Calif., about 1,800 miles. The phone, which uses the "loop-absorption" modulation, has been reported up to 375 miles.

The general arrangement of the apparatus on the table makes it possible for the operator to watch the meters, and to reach the controls of both transmitter and receiver from one position.

R. M. SHERRILL,
 2505 Hartzell St., Evanston, Ill.

August EMPIRE RADIO Bulletin

FOR IMMEDIATE SHIPMENT

VACUUM TUBES

- Audiotrons (Double Filament Type) . . . \$6.00
- Radiotron UV 200 (Detector Tube) . . . 5.00
- Radiotron UV 201 (Amplifying Tube) . . 6.50
- Radiotron UV 202 (Power tube, 5-watt) 8.00

VARIOMETERS AND VARIOCOUPERS

- Fischer Variometer (Small Size) 4.50
- Fischer Variometer (Large Size) 7.00
- Fischer Variocoupler (Small Size) 5.00
- Fischer Variocoupler (Large Size) 7.50

"B" BATTERIES

- 22½ V. (Small Size) "B" Battery 1.00
- 22½ V. (Large Size) "B" Battery 2.00
- 22½ V. (Large Size Tapped) "B" Battery 2.20
- 45 V. (Large Size Tapped) "B" Battery 4.00

SETS

- Federal Jr., complete with aerial equipment \$25.00
- Aeriola Sr., Westinghouse Set 65.00
- Two Step Amplifier, for use with Aeriola Sr. 30.00
- Magnavox, Type R-3, for Radio Use . . 45.00
- Vocarola, Westinghouse Loud Speaker. 30.00

MISCELLANEOUS

- Moulded Vacuum Tube Socket75
- Fada Rheostat 1.00
- Thordarson Amplifying Transformer . . 4.50
- Acme Amplifying Transformer 5.00
- Chelsea Amplifying Transformer 4.50
- Federal Amplifying Transformer 7.00
- Radio Frequency Transformer 6.00
- Audiotron Adapter 1.50
- Western Electric Phones 15.00
- Chelsea Variable Condenser, .0005 . . . 4.25
- Chelsea Variable Condenser, .001 . . . 4.75
- Chelsea Bakelite Dial, 3 in. diameter . . 1.00

Empire Radio Corporation

Manufacturers and Distributors of Radio Apparatus

271 West 125th Street

New York City

The Station of St. John's University

(Continued from page 250)

condenser is below the spark gap. The condenser is immersed in oil, and consists of 18 sheets of brass foil, each 20" by 20", inserted between glass plates ⅝" thick and 24" square. It was designed by C. J. Otterholm of the famous 9HM of St. Paul. The leads from the condenser to the spark gap consist of two heavy copper strips 3" in width, and are approximately semi-circular in form, thus forming the primary O. T. The secondary O.T. consists of six turns of heavy copper ribbon 1" wide, the inner turn being 7" in diameter, and spaced 1". The coupling is 11", center to center. Several feet from the O.T. is the necessary loading inductance. It was found better not to have more than a half dozen turns in the secondary O.T., as more would be equivalent to closer coupling, thus broadening the wave.

The transformer input is controlled by means of an exciting rheostat, so that the potential at the transformer may be varied from 30 to 120 volts. This serves to eliminate undue interference, while communicating with neighboring stations.

The receiving sets have been built principally by the members of the radio club. For the short waves, a single circuit regenerative set, having a range of about 180 to 350 meters, was constructed. A second set ranging from 250 to 600 meters is used, principally for listening to radio concerts. Here the condenser-tuned Armstrong circuit is employed. A third set has a range of 1,000 to 16,000 meters, and brings in the signals from American and European high-powered stations. Recently a two-step amplifier was assembled, which may be hooked up with any of the receiving sets.

Special credit is due to C. J. Otterholm mentioned above, for assisting in bringing the station to its present state of efficiency.

MAKE MONEY AT HOME

YOU can earn from \$1 to \$2 an hour in your spare time writing show cards. Quickly and easily learned by our new, simple "Instructograph" method. No canvassing or soliciting; we teach you how, guarantee you steady work at home no matter where you live, and pay you cash each week.

Full particulars and Booklet free
AMERICAN SHOW CARD SCHOOL
 55 Ryrie Building Toronto, Can.

- Large Variometers, inside windings \$5.00
- Rheostats, with engraved dials and knobs, \$1.40; with tapered knob only, \$1.00. Small engraved knob and dial, 50c. Variometers, hard maple forms, \$5.00. Variocouplers, wound on Formica tubes, \$5.00.

OAK CABINETS

- 6"x14"x7" deep with hinged tops, and reinforced . . \$3.25
- 7"x7"x7" deep with hinged tops, and reinforced . . \$2.25
- 7"x10"x7" deep with hinged tops, and reinforced . . \$3.00
- 7"x12"x7" deep with hinged tops, and reinforced . . \$3.25
- 7"x18"x7" deep with hinged tops, and reinforced . . \$4.25
- 12"x14"x7" deep with hinged tops, and reinforced . . \$4.50

Dealers. Write for Proposition.
MEADE BAKELITE AND RADIO APPARATUS
 27 Howard Ave. Brooklyn, N. Y.

RADIO APPARATUS

*Distributors of Reliable Radio Apparatus to Schools,
Colleges, Radio Clubs and Experimenters
All Over the World!*

“PITTSCO”

Specializing on “RADIO”
CORPORATION'S Products



“PITTSCO”

Now has three Stores.
Send us your orders.

The present tremendous demand for Radio Apparatus has practically made it impossible for us to render our usual SERVICE. Reasonably prompt delivery however can be made on the items listed.

AMPLIFYING TRANSFORMERS	
No. P-1. General Radio, semi-mounted.....	\$5.00
No. 50. Chelsea, semi-mounted.....	4.50
No. A-2. Acme, semi-mounted.....	5.00

ANTENNA WIRE	
“Pittsco” No. 14 hard drawn copper (80 ft. per lb.), per lb.....	.40
500 ft. (Special value).....	2.25
“Pittsco” 7 strand No. 22 tinned copper, per ft.....	.01
500 ft.....	4.00
1,000 ft.....	7.50
“Pittsco” 7 strand No. 20 Phosphor bronze, per ft.....	.02
500 ft.....	7.50

ANTENNA INSULATORS	
No. P-1. Electrose ball insulator.....	.35
No. P-2. Electrose 4 inch strain insulator.....	.45
No. P-3. Electrose 10 inch strain insulator.....	.75

“A” BATTERIES (Storage Batteries)	
Yale 6 volt, 60 Ampere-hour.....	18.00
Yale 6 volt, 80 Ampere-hour.....	21.00
Yale 6 volt, 100 Ampere-hour.....	25.00
Note.—These batteries are shipped carefully crated and fully charged ready for use.	

“A” BATTERY RECTIFIERS	
No. P-1. Tungar, 5 ampere type, complete with bulb	28.00
No. P-2. Tungar, 2 ampere type, complete with bulb	18.00
No. P-3. F F Battery Booster, 5 ampere type.....	15.00

“B” BATTERIES	
No. 763. Eveready, 22.5 volt, small size.....	1.75
No. 766. Eveready, 22.5 volt, large size, 16½ to 22½ volts.....	3.00
No. 774. Eveready, 43 volt, large size, variable.....	5.00

CRYSTAL RECEIVING SETS	
Aeriola, Jr., Westinghouse, complete with telephones.....	\$25.00
Every-man's DeForest, complete with telephones.....	25.00

CONDENSERS (Variable)	
No. 1. Chelsea, fully mounted, .001 Mf.....	5.00
No. 2. Chelsea, fully mounted, .0005 Mf.....	4.50
No. 3. Chelsea, unmounted with dial .001 Mf.....	4.75
No. 4. Chelsea, unmounted with dial .0005 Mf.....	4.25
No. 367. Murdock, fully mounted, .001 Mf.....	4.50
No. 368. Murdock, fully mounted, .0005 Mf.....	4.00
No. 3660. Murdock, unmounted without knob and dial, .001 Mf.....	4.00
No. 3680. Murdock, unmounted without knob and dial, .0005 Mf.....	3.25

JACKS (Radio Type)	
No. P-1. Open circuit.....	.70
No. P-2. Closed circuit.....	.85
No. P-3. Two circuit.....	1.00

LOUD SPEAKERS	
Arkay, horn only, satin finish.....	5.00
Federal Pleiophone, complete with phone.....	14.00

PLUGS	
No. 34-B. Firco, round type.....	2.50
No. P-1. Western Electric.....	1.10

SOCKETS	
No. 156. General Radio, improved model.....	1.50
No. P-1. Chelsea.....	1.00
No. P-2. Clapp-Eastham, bakelite type.....	1.00
No. UR-542. Radio Corporation.....	1.00

TELEPHONES	
No. 56. Murdock, 2,000 ohms.....	5.00
No. 56. Murdock, 3,000 ohms.....	6.00
No. 2A. Stromberg Carlson, 2,000 ohms.....	7.50
No. P-1. Holtzer-Cabot, 2,200 ohms.....	8.00

Let “PITTSCO” fill your orders for any of the above items.
Our SERVICE on these at the present time will please you.

F. D. PITTS CO., Inc.

12 PARK SQUARE

BOSTON, MASS., U. S. A.

WOOLWORTH BUILDING,
PROVIDENCE, R. I.

3 STORES

276 WORTHINGTON STREET
SPRINGFIELD, MASS.



LEARN TELEGRAPHY

(Wireless or Morse)

AT HOME

In Half the Usual Time

Let the OMNIGRAPH Teach You Wireless

"Just Listen—The Omnigraph will do the teaching"

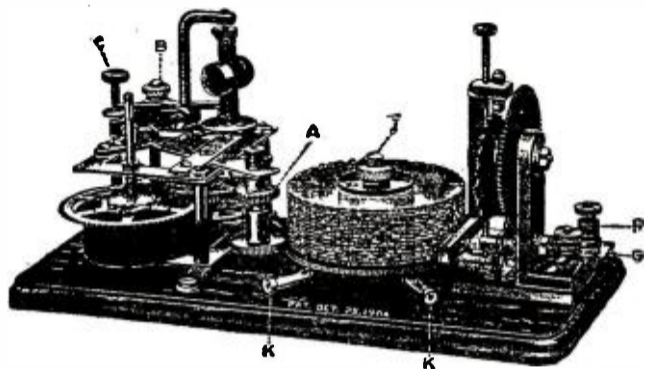

The Omnigraph is an Automatic Transmitter that teaches you both the Wireless and Morse Codes, at home, without any expense except the cost of the machine itself. Merely connect to battery and your Buzzer, or Buzzer and Head Phones, or to your Sounder, and the Omnigraph will send unlimited messages by the hour, at any speed you desire.

USED BY THE U. S. GOVERNMENT

Write for Free Catalogue

For a few dollars you can have a complete outfit that will make you an experienced operator in the shortest possible time. No hard, laborious work—just learn by listening. The Omnigraph is adjustable so you can start receiving messages slowly, gradually increasing the speed as you become proficient.

You'll be surprised how quickly you will attain speed. Even if you are already an operator the Omnigraph will help you. It will make you more proficient, more accurate and more confident. Thousands of Omnigraphs are in use today and thousands of operators owe their success to them.

The Omnigraph Mfg. Co., 20 Hudson St., New York City

KEYSTONE RADIO LIGHTNING ARRESTERS

The Keystone Radio Lightning Arrester is approved by the Board of Underwriters for the protection of receiving sets and the property in which they are installed. They provide permanent protection, have no vacuum to lose, nor fuses to blow. They can be installed out-doors and they take the place of a lightning switch. They are for sale by Radio Dealers everywhere or sent postpaid on receipt of.....\$2.00
Circular and instruction book free on request.

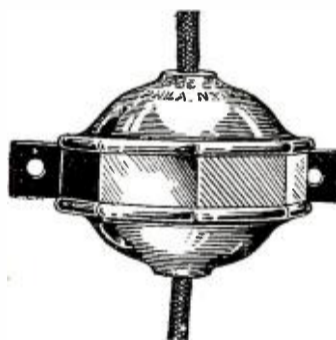

Type A, Keystone Arrester, with wire leads. Price \$2.00

SIMPLEX VARIOMETERS VARIO-COUPLERS

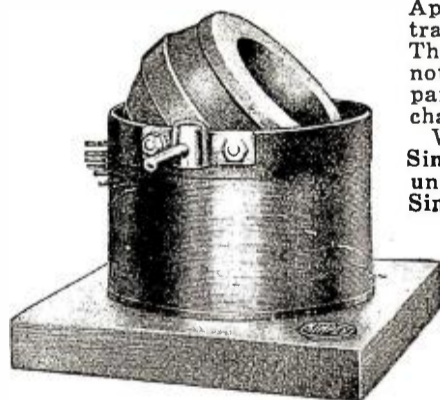

Simplex Vario-Coupler Unmounted, Price \$6.00

Apparatus bearing the Simplex trade mark is high grade material. The material and workmanship is not to be compared with much apparatus having the same general characteristics.

Write for circular describing Simplex Variometers, mounted or unmounted.

Simplex Vario-Couplers, mounted or unmounted.

Simplex Detector Panels.
Simplex Amplifier Panels.
Simplex Filament Rheostats.

For sale by Radio Dealers everywhere.

Electric Service Supplies Co.

Mfrs. of Lightning Arresters for 30 Years
Distributors for Simplex Radio Co.
17th & Cambria Sts., Phila.

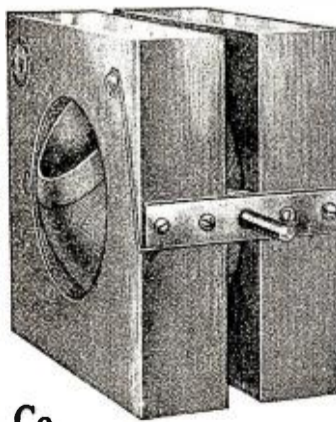

Simplex Variometer Unmounted, Price \$6.00

Radio Instruction at Camp Alfred Vail

(Continued from page 222)

frequency measurements, practical laboratory, portable telephony, auxiliary station equipment, main station equipment.

Students pursuing courses of radio-telegraphy and radio-telephony at Camp Alfred Vail are given the advantages of seeing at first hand many of the products of the Signal Corps radio research laboratory. Here significant developments and inventions of the United States Army in the realm of wireless appliances are subjected to critical field tests. The inventions of Major-General George O. Squier, Chief Signal Officer; Dr. Louis Cohen, chief consulting electrical engineer; R. D. Duncan, Jr., chief of the radio research laboratory, and the radio developments of other investigators in the Signal Corps may be submitted for preliminary trials at Camp Alfred Vail.

The United States Army is in a position to retain a constantly increasing number of the graduates from the Signal Corps School at Camp Alfred Vail for its own service. Electric, telegraph, and radio companies, moreover, give assurance that graduates from this school are highly qualified to supply vacancies in their services. Hence, once the graduate has been honorably discharged from the United States Army he should experience little difficulty in securing civilian positions. Inquiries concerning (or applications for entry therein) the Signal Corps School should be addressed to the Commandant at Camp Alfred Vail, New Jersey, who will freely give information and advice as to present opportunities for enlistment to pursue studies in radio-telegraphy and telephony.

Seven New Radio Stations Have Combined Power Capacity for Transmitting Communications 46,750 Miles

(Continued from page 225)

the west by uni-directional receiving apparatus. According to the transmission formula, for distances beyond 2,000 miles, in order to keep up a given strength of received signal, the antenna current must be nearly doubled, that is, the power must be quadrupled approximately for every additional 700 miles of distance. The antenna current for continuous communication to Shanghai must then be, if the formula is correct at this distance, about twenty-one times that required for continuous communication from San Francisco to Honolulu, since the distance is 3,200 miles greater."

Communication between Holland and Java, a distance of 6,100 miles, is anticipated when two radio-telegraph stations, now in the course of erection in these countries, are completed. The electric reservoir in Holland is located near Amersfoort, and is computed to approximate the power possessed by the station at Nauen, Germany. The powerful radiation base in Java is situated in the Malabar mountains. The novelty of the antenna construction elicits curious interest. The antenna is suspended between cables stretched across a gorge 3,000 feet deep. Mountain walls, by radio engineers, have not heretofore been considered as surroundings serving the interest of antenna efficiency. In this instance, however, recent experiments have exploded this belief and the antenna when fringed by mountain barriers has demonstrated its ability to function satisfactorily. During the World War, this arrangement was put to a critical test when attempt was made to establish communication with Hol-

Wholesale RADIO Retail

COMPLETE STOCK. PROMPT SERVICE.
SPECIAL DISCOUNT TO DEALERS.
SEND FOR OUR CATALOG AND SAVE TIME AND MONEY.

CHICAGO ELECTRICAL SUPPLY COMPANY

360 West Madison St. Chicago, Illinois

RADIO DEALERS

IMMEDIATE DELIVERIES
ATTRACTIVE DISCOUNTS

Dials, Headsets, American Beauty Receiving Sets, Variable Condensers, Transformers, Rheostats, Variocouplers, Panels, Tubes, etc. Standard Goods.

Write for Price List of Complete Line
AMERICAN RADIO MFG. CO.
Jobbers 223 Admiral Blvd.
DEPT. A, KANSAS CITY, MO.

Edelman's "Multitone"

Quality Radio Sets and Parts—Guaranteed Satisfactory—Prompt Deliveries—Hear Baseball Scores and Hourly Stock Market Prices with the Set You Build from "Multitone" Radio Parts

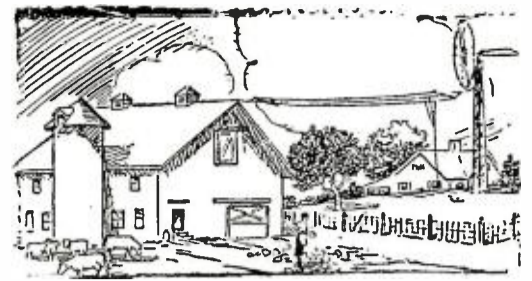

"Aladdin" Set Makes Farm Life Interesting!!



A real loud speaker complete, ready to attach to your amplifier; all wood tone chamber in base; scientific horn. Only \$15.00 Complete Two Step Amplifier for above, attachable to any make set—only \$36.00

ALADDIN SET

This Aladdin Multitone Set is not a toy. It comes in a complete package with aerial, phones, lightning arrester, insulators, and all ready for radio music the same night you take it home. Aladdin Multitone Sets (registered U. S. Patent Office) are extra well built.

Buy your Set Now and Please the Family

Usual range, 30 miles; price, complete with instructions only \$22.00

Extra head set for same, so that four people can hear the radio music at one time \$8.50

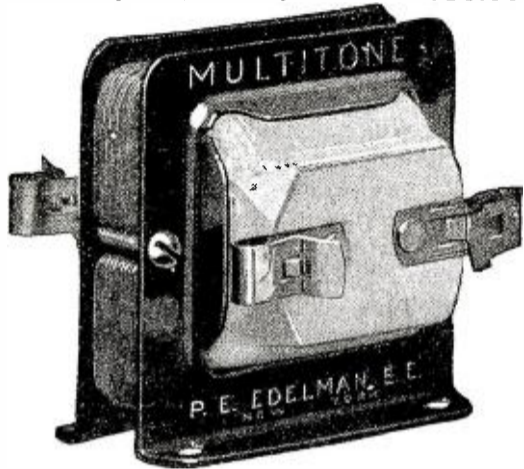
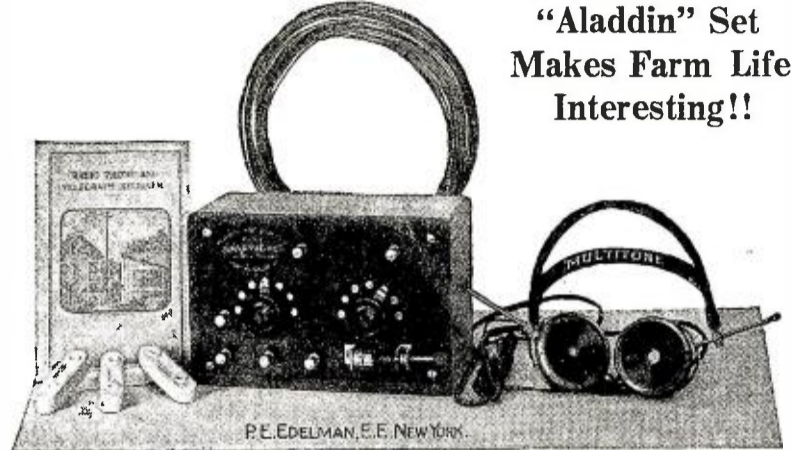

TRANSFORMERS

By actual tests it has been proven that these "Multitone" transformers give enormously greater amplification than most other makes on the market. Each terminal is properly labeled. Exceptional value, only \$5.50

MAKE YOUR OWN

Complete parts for constructing two stage amplifier, comprising two transformers, two sockets, rheostats, wire, panel, cabinet, binding posts, with blue print instructions. Price, only \$17.90

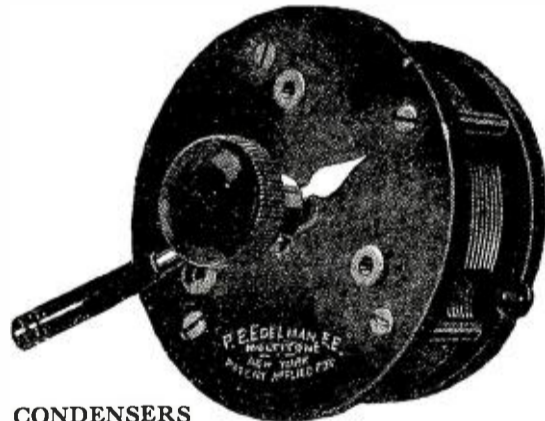

CONDENSERS

Edelman's "Multitone" Condensers are exceptionally high grade. Adopted by leading manufacturers. Complete with beautiful etched dial ready for panel mounting, patent laced plates, machine bushed bearings, vernier adjusting handle, 23 plates, .0005 M.F. Only \$4.50 Same, 43 plates, .001 M.F. (built to last), accurate. Only \$5.50 Special! 43 plate condenser (second grade), panel mounting, only \$3.20 Same, 23 plate (second grade), panel mounting \$2.40 3-inch dial and knob for above, 0° to 100° only 60c

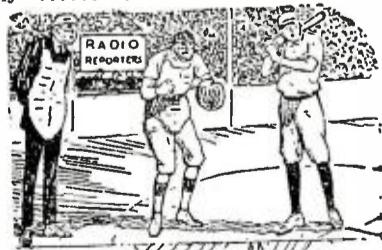

THROW YOUR AERIAL AWAY— and LAUGH AT THE LANDLORD

Attachment for lighting socket, comprising plug, mica condenser, switch, and instructions for use with vacuum tube and crystal sets, price only \$1.95

PHONOGRAPH ATTACHMENT

makes a loud speaker out of your own head set attached directly to your phonograph. Handsome finish. Complete with instructions. \$4.25

EDELMAN'S FAMOUS LOAD COILS

Just attach to your set. Instructions furnished. You can hear government stations which broadcast higher wave-lengths. Sizes, No. 12, No. 14, or No. 16 ft most sets, only \$2.00

Special coil No. 1216 for regenerative outfit, such as Westinghouse R. C. 3. \$3.75

EDELMAN'S MULTITONE RHEOSTAT

5-ohm 2 amp. capacity, wound on genuine heat resisting lavite base, price \$1.50 Same, 4 amp. capacity, two switch arms (patented) so that detector and amplifier tubes can be worked together, only \$2.10 Blue print showing how to erect the most efficient broadcast aerial for apartment house or residence. Price 25c

DIALS, KNOBS, SWITCH LEVERS

3-inch dial and knob. 60c
Switch lever, handsome finished. 40c
Switch points, nickel-plated, each. 2 1/2c
Phone condenser, .001 mf. 35c
Grid leak condenser. 35c

WESTERN ELECTRIC LOUD POWER SPEAKER

complete, with horn and vacuum tubes. \$161.00
U. V. 201 amplifier tubes (in stock). \$6.50
AERIOLA, Sr., complete with vacuum tube and batteries and aerial package—Ideal for vacations! \$72.50
RADIO FREQUENCY TRANSFORMERS, 200 to 600 meters \$6.00
One stage special amplifier without vacuum tube \$11.00

COMPLETE ANTENNA PACKAGE

consisting of 100 feet copper-weld aerial wire, 25 feet Underwriters approved lead-in wire, 4 aerial insulators, 1 genuine Brach lightning arrester, 1 Edelman ground clamp, and illustrated instructions, only \$4.90
Brach Lightning Arrester, approved. \$2.20

EDELMAN'S MULTITONE GALENA

Every crystal guaranteed sensitive super-tested, price, only 35c
Same mounted to fit standard size cup. 35c
Same containing silver pyrites crystal. 35c

LOUD SPEAKER DE LUXE

comprising a wood horn, genuine mahogany finish, fitted with Baldwin phone. Can be heard a distance of 200 feet when used with Edelman's two step amplifier. Price \$27.50

Distributors—Dealers—Agents—WIRE

P. E. Edelman, E. E., Mfr. Est. 1910
9 Church St., New York City.

Edelman's Head Sets Now Ready

Manufacturers, Distributors and Dealers Supplied at Attractive Discounts

AN EFFICIENT HEAD SET

carefully designed by Mr. P. E. Edelman and Mr. David Grimes, experienced radio and telephone engineers, to give maximum sensitivity in a durable, light weight instrument. The new "Multitone" head set is mighty comfortable. It brings in clear toned results on faint signals. Supplied with genuine leather covered adjustable head band. May be used on amplifier sets in connection with loud speakers. The special diaphragm will not rattle on loud reproduction.

The feature of the "Multitone" head sets is the patent fulcrum diaphragm support. This permits the diaphragm to vibrate freely. In most other makes of phones the diaphragm is held tightly and dead in the receiver case. If you already have one pair of phones, take home an extra pair of Edelman phones and let the whole family listen-in.

REAL PHONES. Edelman's Multitone Headsets were specially made to bring in real music, not merely code buzzes. Genuine Condensite molded shells inclose the latest word in sensitive radio-phone durable receivers. Every headset tested.

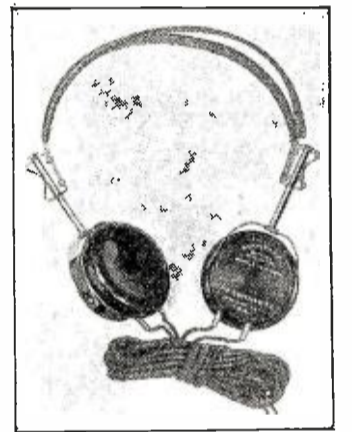

The new Edelman Multitone Headset should not be judged by its low price. It is a high grade, sensitive tone product. The word "ohms" on any headset means nothing. We give you more than the rated 2200 ohms, and the design is such that you get most efficient sensitivity combined with durability for clear-toned music reproduction. The name "Edelman Multitone" is cast on every receiver. Accept no substitute. Worth the price. Double. \$8.50
Same, Single, only \$4.10

Genuine Gould storage battery, 6 volts 80 amp. hr. \$18.00
Multiple storage battery, 6 volts 80 amp. hr. \$14.50
22 volt B battery. \$1.00
Genuine storage B battery, 25 volts made specially by Gould Storage Battery Co. for P. E. Edelman, New York. Price, only \$8.00
Variometers, large size, each \$6.00
Variocouplers, large size, each 6.00
Fixed condensers dubilier, any size, each \$0.50

EDELMAN'S MULTITONE GALENA
Every Crystal Guaranteed Sensitive
SUPER-TESTED
Price, 35c.
P. E. Edelman, E.E.
New York, N. Y.

Edelman's genuine silver contact vacuum tube socket has rubber tires to protect your expensive vacuum tube from damage. Designed for minimum capacity and electrical losses. Use this socket and note the improved results immediately. \$1.00
Price, only \$1.00

"Experimental Wireless Stations." Leading instruction book. Postpaid. \$3.00

ASK FOR CATALOGUE

Mr. Philip E. Edelman, 9 Church St., New York City, U. S. A.
Please send to me as soon as possible (Mark "X" to show what you want, clip and mail today).....
Catalogue, for which I enclose 15c stamps, and.....
....., which I could not get at my dealer's, whose name and address is.....
Enclosed find money order for.....dollars and.....cents.
I would also like to buy.....
for use to.....
I am printing my full name and address below in margin so that your mail clerk can read it. Signed—



Insist on Getting

U. S. EAGLE GALENA, 25 Cents

U. S. EAGLE GOLDENA, 35 Cents

MOUNTED U. S. EAGLE GALENA or GOLDENA, 2-in-1, 50 Cents

Patent Applied

Marvelous Crystals of sensitivity; Improve your Radio Reception by the use of these Crystals. No better on the American Market. Each Crystal is packed in a container and labeled U. S. Eagle Galena or U. S. Eagle Golden.

Attractive proposition for dealers and jobbers. Immediate shipment. Will use your own labels on request. Also in bulk.

EVERYTHING IN RADIO SUPPLIES SEND 10 CENTS FOR CATALOGUE

U. S. RADIO CO. of PENNA., Inc.

Distributors and Manufacturers of Radio Apparatus

Corner of Ferry and Diamond Streets
Pittsburgh, Pa., U. S. A.

IF IT'S } **NEW ORIGINAL BETTER**

Mazda Radio Makes It

Variable Condensers
2,000, 3,000, and 4,000 Ohm
Head Sets
Amplifying Transformers
Jacks

Plugs
Carbon Rheostats
Binding Posts and Screws
Contact Points
Switch Points

and other necessary accessories

Absolute Guarantee of Quality. Very Attractive Prices

The Mazda Radio Manufacturing Company
1830-40 East 35th Street :-: Cleveland, Ohio

RADIO TUBES

Orders Filled Same Day as Received

DETECTORS (No. 200) \$4.00

AMPLIFIERS (No. 201) 5.00

Cash With Order

5% discount on orders \$50.00 or over.

RADIO TUBE DIST. CO.

1437 1st Ave., N. Y. C., N. Y.

SPEED UP YOUR PRODUCTION

by sawing bakelite, formica, brass, copper, carbon, or wood on a

JUNIOR BENCH SAW

A precision machine especially adapted to the rapid and accurate production of small duplicate parts. All metal construction. Top 10"x13", elevates for grooving, tilts 10 degrees for leveling. Saws 1 1/2" stock. Easily driven by 1-4 hp. or 1-3 hp. motor. Attachments for grinding and sanding. Special saws for bakelite, brass, etc. furnished from stock.

Junior Bench Saw with guides and one 6" wood saw . . . \$28.75
Motor Driven Unit as shown, mounted on iron base with 1-4 hp. ball-bearing motor, belt tightener, belt, cord, plug, and switch, \$60.00.
Write for fully illustrated circular.
Manufacturers and amateurs will be interested in our Handlathe, Junior Bench Drill, Handsaw, and ball-bearing motors.

W. & J. BOICE, Dept. 708, 114-23rd St., Toledo, Ohio.

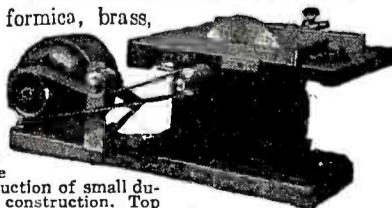

land without resorting to the use of cables. The results were reasonably satisfactory, messages being dispatched to Holland at night with only moderate power consumption, provided wave-lengths of 5,000 to 6,000 meters were employed. Obviously, such abbreviated wave-lengths could not function over the distance of 6,100 miles during daylight hours.

France, too, is ambitious to maintain communication by radio-telegraphy over distances not heretofore possible. Its efforts in this direction are being concentrated in completing the powerful wireless transmitting base at Sainte Assise, between Fontainebleau and Paris. Intercourse, by means of dots and dashes, will likely be established with Saigon, Indo-China, 5,500 nautical miles, and Buenos Aires, 5,950 miles away. The antenna for this pretentious and far-reaching service is of the double Marconi design, built in two parts, with independent down leads in the center. Support for the antenna is assured by means of sixteen 250-meter towers in two rows, 400 meters apart. Two 500-kilowatt Latour alternators will furnish high-frequency current. These reservoirs of electricity will be employed separately on the two antennæ, or when advisable, they may be placed in parallel with the latter. Thereby, 1,000 kilowatts of current will be available, affording between 1,000 and 2,000 antenna amperes. The radio-telegraph receiving base for the powerful Sainte Assise is located at Villecresnes, where there are six two-story brick buildings. The second stories of these structures are receptacles for the receiving coil antennæ, while other accessory reception units are found on the ground floor. Other than the high-power station at Sainte Assise, there is also a less pretentious radio-telegraph transmitting unit for maintaining communication with European points. Structurally, it consists of a single mast, 250 meters in height, supporting four antennæ, which may be employed independently or as a unified system. High-frequency current has its source in four 25-kilowatt alternators. Then, too, as a third system of intelligence, there is a low-power tube generator station with a 100-meter mast for exchanging dot-and-dash intercourse with London and intermediate points.

England, while ambitious to establish long-distance radio-communication, is seeking means other than covering the intervening space at a single wide swath, figuratively. Not unlike stop-over points arranged for by transportation companies for excursionists on long journeys, the Imperial Committee, headed by Sir Henry Norman, proposes to dissipate distance by establishing a series of moderate-power radio-telegraph stations, spaced at intervals not exceeding 2,000 nautical miles. The first station in the chain was opened the past summer at Leafield, near Oxford, whereby communication is to be maintained with a station about to be erected near Cairo. From the latter point the English system divides, one line extending its ramifications to South Africa with an intermediate base in East Africa, while the other divisional chain is expected to reach Australia by way of India and Singapore. The Leafield electric-reservoir has been equipped with a 300-kilowatt arc, affording a current of approximately 200 amperes in the antenna. The masts, at present only 300 feet high, will be displaced by others of a height of 600 or 800 feet.

The recently completed high-power station of the Radio Corporation of America, near Port Jefferson, Long Island, New York, of which there have been vivid and numerous descriptions, represents an effort hitherto unapproached in the United States for establishing extremely long-distance radio-telegraph intelligence. New York is thereby connected with Argentine, annihilation of a distance of 4,500 miles. This huge electric reservoir, which someone has described as twelve stations in one, will probably be, when completed, the most powerful in the world.

"RASCO HAS IT!"

THE Radio Specialty Co.—"Rasco" for short—is probably the most unique supply house in the United States, if not in the world to-day. This company makes a specialty of small orders, no order being too small to get immediate and prompt attention for the simple reason that most of our orders are small.

The reputation of this house was built upon service. Ask any of your acquaintances what they think of Rasco goods, Rasco service, Rasco promptness! Thousands of unsolicited testimonials on file to prove that we serve the public best! Be sure to get our great catalogue, containing several hundred different parts, which is illustrated below.

ORDER DIRECT FROM THIS PAGE. ALL GOODS SENT PREPAID IN 24 HOURS

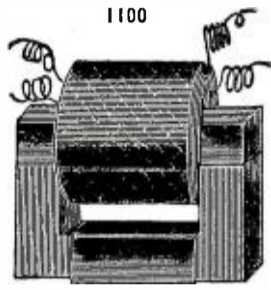

"RASCO" AUDIO FREQUENCY TRANSFORMER

We have compared many of the present transformers on the market but have finally decided upon a type that is the most efficient one we have seen so far. The best amplifying transformer is that in which the impedance of its primary is equal to or exceeds the impedance of the plate-to-filament circuit of the

tube in which it is connected. We guarantee this transformer to equal any one on the market. No. 1100 "Rasco" Audio Frequency Transformer (not assembled) each prepaid.....\$2.65

ANTENNA CONNECTOR

This antenna connector is made entirely of aluminum, is light and will not rust. The only connector of its kind. The 4 antenna wires go to the upper holes; the lower hole takes the lead-in. Don't solder your aerial, don't have loose connections. Dimensions 2" high, 1 3/4" wide, 3/8" thick. No. 999, Connector, each...\$0.35



999



PANEL KNOBS

No. 6241 is well made and has a good corrugation. Its dia. is 1", height is 1/2", hole 5/32". The shank is 1/4" high. No. 6241, Knob, each.....\$0.08



838

MARCONI KNOB

Has a central hole of 5/32" and seat to hold the screw. dia. is 1 1/4", height 3/4". No. 838, Marconi Knob, each.....\$0.15



RASCO POSTS

These are our very own patterns, from our own designs and look mighty handsome on any instrument. The top knobs are of composition, the bottom parts brass nickel plated polish. No. 202, Post, each,.....\$0.08



650

BRASS NICKEL POSTS

No. 029, Binding Post, each.....\$0.05
No. 030, Binding Post, each.....\$0.04



RASCO SWITCH POINTS

Nickel plated and polished. The following have been found the most popular. No. 1 1/4" x 3/4", 6/32 thread, ea., \$0.03; doz., 35c

- No. 2, 3/16" high, 1/4" dia., 6/32 thread, ea., \$0.03; doz., 35c.
- No. 3, 3/16" x 3/16". 4-36 thread, ea., \$0.03; doz., 35c.
- No. 4, 3/4" dia.; 1/2" thick; stem 6/32, ea., \$0.03 1/2; doz., 40c.
- No. 5, 1/2" dia., 3/16" thick; stem 4-36, ea., \$0.03 1/2; doz., 40c.
- No. 6, 3/16" dia.; 3/16" thick; stem 4-36, ea., \$0.03 1/2; doz., 40c.
- No. 7, 3/16" dia.; 1/8" thick; stem 4-36, ea., \$0.03 1/2; doz., 40c.
- No. 75, Switch Stop, 7/8" long, 4-36 thread, complete with nut, ea., \$0.05; doz., 50c.
- No. 76, New style Switch Point, to be pressed into bakelite panels with forced fit. Wire is soldered to pin end. Head 1/4"; dia., 1/16" thick, ea., \$0.03 1/2; doz., 40c.
- No. 77, same as above, but head is 3/4" dia. x 3/16" thick, ea., \$0.03 1/2, doz., 40c.

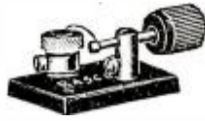

THE RASCO BABY DETECTOR

In presenting this little Detector, we feel sure that it fills a place never taken before by any small detector. It does a variety of things and does them all well and better than many \$5.00 detectors. The base is solid, black composition. Mounted on same is a nickel holder and binding post which holds a fluted hard rubber knob with its sliding rod member. The outstanding part of the Detector, is the patented nickel detector cup and binding post. The knurled cap unscrews and you place the Galena Crystal in the cup, then replace the knurled cap and the galena crystal is held secure. The circular hole in the cap exposes enough of the crystal for ordinary purposes. No.1898, Rasco Baby Galena Detector. Price, prepaid.....\$0.50
No. 1899, Rasco Baby Detector with Galena and Radiocite Crystals. Price, prepaid.....\$0.75

PANEL SWITCH LEVER

New style switch lever with lock fork. It is impossible for this lever not to make positive contact at all times. The blade radius is 1 1/4". Blade is nickel plated and polished. Fork is phosphor bronze. The lock fork holds the screw (in which it rotates), securely. A loose contact is impossible. No. 200, Switch Lever, complete as illustrated...\$0.30



200



323

LITZ WIRE

This wire is recognized as the only thing for winding coils for Radio instruments. Particularly recommended with our No. 343 Variocoupler Rotor, for vario-couplers, banked windings, etc. No. 323, Litz Wire, 20 No. 38 strands, enameled double silk wire, per foot, \$0.02; per 100 feet, \$1.15
No. 890, Litz Wire, 10 strands No. 38 wire, per foot, \$0.01; per 100 feet, \$0.75.
No. 891, Litz Wire, 16 cables of three strands No. 38 wire, per foot, \$0.03; per 100 feet, \$2.25.

NOTE: This page contains only a few of our 300 specialties.



343

PANEL KNOB

This is a very distinctive knob and can be used on dials, panels, switches, condensers, etc. It is exceptional and well made. Dia. 1 1/16"; height 11/16"; comes with 8/32" bushing. No. 815, Knob, each.....\$0.18



815

VARIOCOUPLER ROTOR

This rotor is used by all up-to-date amateurs. Is accurately turned of hard wood and is used as a secondary coil. It takes any finish, either shellac or stain and can be drilled readily for any size hole. Large hole 2" dia. Width of spool is 2". Total dia. 3 3/8". No. 343 Variocoupler Rotor, each.....\$0.75



827

"RASCO" NAME PLATES

Our name plates are of brass with a black background. Letters are polished nickel. Order by name and number. Each.....\$0.05

807 "Phones"	Each \$0.05	810 "Ground"	Each \$0.05
809 "Aerial"	Each \$0.05	812 "Primary"	Each \$0.05
811 "Secondary"	Each \$0.05	814 "Detector"	Each \$0.05
813 "Audion"	Each \$0.05	816 "On"	Each \$0.05
865 "Off"	Each \$0.05	840 "Increase Current (Right)"	\$0.10
839 "Increase Current (Left)"	\$0.10	834 "Series"	Each \$0.05
813 "Vacuum Tube"	Each \$0.05	830 "Receive"	Each \$0.05
831 "Transmit"	Each \$0.05	820 "2nd Step"	Each \$0.05
821 "3rd Step"	Each \$0.05	827 "Tickler"	Each \$0.05
819 "1st Step"	Each \$0.05	825 "Plate Variometer"	Each \$0.05
826 "Grid Variometer"	Each \$0.05	835 "B Battery"	Each \$0.05
823 "Secondary"	Each \$0.05	817 "Output"	Each \$0.05
836 "A Battery"	Each \$0.05	824 "Primary Condenser"	Each \$0.05
818 "Input"	Each \$0.05	828 "Parallel"	Each \$0.05
829 "Telephone"	Each \$0.05	837 "+ -"	Each \$0.05
833 "Detector Tube"	Each \$0.05	841 "(Blank)" (takes pen or pencil writing)	Each \$0.05
822 "Coupling"	Each \$0.05		
808 "Loadg Coil"	Each \$0.05		

Price of all of our name plates in dozen lots, 50c, with the exception of the two "Increase Current"



839

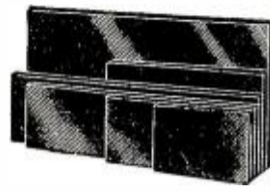

350-55

BAKELITE PANELS

We list below six panels, the sizes of which have been selected after carefully checking up many dimensions of the most popular radio apparatus on the market. Note particularly that our prices are anywhere from 25 to 50% lower than those quoted by most other concerns. The reason is that we buy these panels in very large quantities, and we do not cut sheets to order. Remember always that when sheets are cut to order they cost you at least 50% more than our prices, because you must pay for the cutting and the necessary waste. Note also that we ship these panels prepaid. This alone amounts to a considerable saving.

No. 350	6" x 12" x 3/16" thick, each	\$1.90
No. 351	6" x 18" x 3/16" " " "	2.85
No. 352	9" x 12" x 3/16" " " "	3.00
No. 353	12" x 18" x 3/16" " " "	5.65
No. 354	6 1/2" x 19 1/2" x 3/16" " " "	3.50
No. 355	6" x 7 1/2" x 3/16" " " "	1.20

"RASCO" LUBRICATED PANEL SWITCH

A radio switch that has two nuts at the end is a monstrosity, for the reason that it will never stay put. Our patent spring fork holds the switch handle always under uniform tension, at the same time it insures the best contact possible. New wiping contact, which covers every point of the switch point. Another new improvement is the lock fork, which can assume three different positions to accommodate the switch to various thicknesses of panels. No. 1921 "Rasco" Switch, as illustrated, each \$0.50.



1921



199

KNOB These knobs are favorite with all experimenters. The size of both is: dia. 1 1/8", height 1 1/8". No. 4451 comes with 8/32 and 10/32 bushing. No. 4451, Knob, each...\$0.06
No. 199 (screw length 1/2")



4451

Knob, each.....\$0.10

NAVY KEY KNOB

This navy key knob is now used on all standard wireless keys. It gives the right swinging motion and rests the fingers. It is a favorite with all advanced amateurs. Once used always used. The screw is 8/32 and will fit all keys. No. 748, Key Knob, each.....\$0.28



748



803

THREADED BRASS ROD

We carry two styles, 6/32 and 8/32 thread. Only 6" lengths sold. No others. No. 8032, Threaded Brass Rod 8/32 thread, per 6" length.....\$0.08
No. 6032, Threaded Brass Rod, 6/32 thread, per 6" length.....\$0.06

THE "RASCO" CATALOG

CONTAINS 50 VACUUM TUBE HOOK-UPS

Complete hook-ups of all important vacuum tube circuits are given in clear diagrams with complete explanation. Just to name a few, —The V.T. as a detector and one-step amplifier; regenerative circuit; De Forest ultradion; V.T. to receive undamped and spark signals; Armstrong circuits; one step radio frequency amplifier and detector; three stage audio-frequency amplifier; short wave regenerative circuits; V.T. radio telephone; 4-stage radio frequency amplifiers; radio and audio frequency amplifier, inductively coupled amplifier; Armstrong superautodyne; radio frequency amplifier and crystal detector; etc., etc. The catalog contains 200 illustrations. On account of its great cost, it cannot be distributed free of charge. Mailed only upon receipt of



96-98 Park Place New York

15c in stamps or coin.



96-98 PARK PLACE, NEW YORK CITY

DEALERS

Get Our Special Proposition

Factories Brooklyn, N.Y.—Elkridge, Md.



Cooper

RADIO BATTERIES

Specially designed for Radio Use

6 volt	40	Ampere	Hours
6 "	60	"	"
6 "	80	"	"
6 "	100	"	"
6 "	150	"	"

If your local dealer does not handle Cooper Batteries, write us for nearest distributing point.

RUB-MIKA

Rub-Mika, the ideal material for panels, rotors, knobs, dials, sockets, handles and other parts for radio and electrical equipment. Rub-Mika is not affected by atmospheric changes; does not warp, shrink, expand, check or crack. A perfect non-conductor. Costs less than other materials used for similar purposes. Send us samples or blue prints of your parts and let us quote you prices.

THE COOPER CORPORATION

Tire and Hard Rubber Mfg. Division	General Offices	Battery Mfg. Division
Findlay, Ohio	Cincinnati, Ohio	Cincinnati, Ohio

The Bureau of Standards says—

USE COPPER

(See Circular L. C. 43)

Since its inception, the development of the use of electrical current for transmitting messages has been based on Copper.

No other commercial metal has the ability to resist corrosion, the ease of handling, the fine properties of translating sound impulses into sound again that Copper has.

Why, then, reduce the efficiency of your sending or receiving set by using less effective metals for Copper's work?

Be guided by the experiences of the pathfinders in transmitting sound and energy by electrical impulse. Use Copper for Antennæ, Grounds, Coils, etc., etc.

COPPER & BRASS

RESEARCH ASSOCIATION

25 Broadway - New York

CANADIAN AMATEURS!

HEADQUARTERS FOR THE BEST RADIO EQUIPMENT

Write for Price List

SCIENTIFIC EXPERIMENTER, Limited

33 MCGILL COLLEGE AVENUE MONTREAL

Insure your copy reaching you each month. Subscribe to Radio News—\$2.50 a year. Experimenter Publishing Co., 53 Park Place, N. Y. C.

The Newspapers' Part in Radio Development

(Continued from page 246)

the former being the first national figure to use the broadcasting facilities.

A flood of letters to the newspapers asking information as to how to construct radio sets and further knowledge on the principles of radio, resulted in an arrangement by the *Chicago American* with the public school authorities to furnish copy, diagrams and photographs from the technical departments capable of setting forth the whole subject in an educational way, calculated to help those who were eager to learn more about radio construction.

With this new phase of publicity the schools themselves got busy. Albert G. Bauersfeld, director of technical training and Principal Bogan at Lane, with C. A. Carlson of the woodworking department and Jack Callanan, the radio "fan" who knew the answer to every question, Austin High School's technical experts, C. J. Herringshaw, of the electrical department at Sheldon High School and with the Tilden experts finally the construction work was launched, culminating in the Radio Show staged by the *American* and viewed by thousands.

Construction of the smaller crystal sets and various hook-ups, conducting of "Questions" and "Answers" columns, drawings and instructions apart from these layouts in national publications, was due to the hearty co-operation of the newspapers with the Chicago High Schools.

Of course the Westinghouse broadcasting plant "KYW," under the guidance of that company's radio directors, was primarily responsible for awakening this part of the world to the possibilities of radio. Later on the municipal radio broadcasting station "WBU" entered the field. Then the Illinois Bell Telephone Co. took a hand. Wires could be leased, regular telephone wires from any subscriber, direct to "KYW," and anybody could broadcast, provided the Westinghouse directors thought it was a drawing card. The Chicago Board of Trade was not slow to take advantage of this facility for spreading its market reports and quotations to all points of the compass. It was now possible to flash news by telephone for broadcasting, and prize fights were listed on the same program where possibly a mid-week sermon was listed.

Group organizations, classes in all parts of the city are holding radio evenings, many of the high school experts presiding. *The Daily News*, the *Journal*, *Herald-Examiner*, *American* and *Post* have vied with one another to give the public the latest word by print and diagram and photograph of what is new in the fascinating field of Radio.

That the "Radio Page" is here to stay is not denied anywhere. Co-operation between newspapers, the schools and the public seems to be growing by leaps and bounds as the scores of letters increase daily and interest in the "Questions" and "Answers" departments has become a problem for editorial departments.

Impetus to local enthusiasm will be given by the Pageant of Progress Radio Exposition and the big Radio Congress in August. The sending range of the big broadcasting stations has been increased and the public of the middle west has become educated, through the newspapers, to the belief that cheap radio equipment is a poor investment.

AND THEY ARE NOT GAS CONTENT!

With the exception of editors, few things are as critical as a vacuum tube.

By A. J. De Long

Tropical Stations of Unusual Interest

(Continued from page 224)

meters. As at Swan Island, the "handy man" is compelled to go out in the building and start the engine, when a schedule must be worked. By having things arranged in this manner, all bothersome noises from either the generators or rotary are eliminated and therefore obviates all chances of possible QRM to the man on watch. Connections between the two buildings are made by having a heavy cable strung overhead. The receiver in use is a Wireless Specialty Type I. P. 500 and is used in conjunction with a two step amplifier. The dials have been so marked that by turning them to certain marks it will be easy to hear the other company stations, regardless of the wave-lengths they may be working on.

Traffic destined for points in the United States is routed via "US" and "WNU," but during the static season it is often necessary to give messages to company ships, when unable to work either specified station, in this way getting rid of traffic with least delay. According to the company's code, "Great White Fleet" ships are compelled to take any and all traffic from these stations, when asked to do so. There is a charge of eight cents per word on relaying traffic for ships operated by other concerns, regardless of the prefix. An interesting point in the radio regulations of the United Fruit Company, is that relative to the prefixing of messages. A message destined for an individual residing in the same place or city as the station it is transmitted to, will bear the prefix "CITY," while those addressed to places where other stations are located and which are to be relayed, will be prefixed "TRU."

The station at Santa Marta (UCJ) is just as interesting as the others and those visiting it will find the operators the same as the others, hard working and business-like, but jolly. No matter how many schedules they are forced to pass over, due to atmospheric conditions, they remain the same, for it is beyond their power to remedy this setback. Although in a portion of the globe where there are few English speaking individuals and very little enjoyment, the boys are happy, for the company is keen on giving them all the comforts of home—piano, pool table, shower baths and in fact everything they desire, to make them contented. But even with all these comforts one soon tires of the monotony, always the same things and same people, day after day.

The aerial is stretched between four high tubular steel masts, set about 600' apart, with a lead-in almost 100' long. Here too, the power unit is installed in an outlying building, as are the condensers, transformer and "O. T." Two large gas engines are employed for driving the 25-K. W. generators at a speed of 1,500 R. P. M. A separate engine is used for operating the two units which are so rigged up that either one may be used in case of emergency. In this same room are also located the bank of storage batteries and switchboards. The various connections are made with copper braid, 2" wide and 1/8" in thickness, buried below the surface of the earth. For some time a receiver on the style of "Marconi 101" was in use, but after experimenting with a Wireless Specialty outfit, it was decided to change. Employing a two step amplifier NAA, NSS, NBA and even European stations can be easily copied. The inhabitants of Santa Marta rely upon the wireless station for outside news.

Photographs by courtesy United Fruit Company.

Radio panels and Radio Parts

Start right. The panel is the very foundation of your set. High volume and surface resistance are essential factors. Make sure that you get them in both the panel and parts that you purchase. To make doubly certain look for the dealer displaying this sign:

CONDENSITE
CELORON

Radio Panel Service

Condensite Celoron Grade 10—approved by the Navy Department Bureau of Engineering—is a strong, handsome, waterproof material, high in resistivity and dielectric strength. It machines easily, engraves without feathering and is particularly desirable for panels. It is also widely used for making many other important radio parts, such as tube bases, platform mountings, variable condenser ends, tubes for coil winding, bases, dials, knobs, bushings, etc. We are prepared to make these various parts to your own specifications.

Where economy is a factor we can supply panels of Vulcanized Fibre Veneer made of hard grey fibre, veneered both sides with a waterproof, phenolic condensation product. This material has a hard, smooth, jet-black surface, machines and engraves readily and will give excellent service where very high voltages at radio frequencies are not involved.

Shielded plates (patent applied for) are made with a concealed wire shield. This shield, when properly grounded, effectively neutralizes all howl and detuning effects caused by body capacities.

Send today for our Radio Panel Guide

Are you an enthusiast? This Guide describes our panels in detail—gives tests—and tells just how much the panel you want will cost.

Are you a Radio Dealer? Let us tell you how easily and profitably Celoron Radio Panel Service enables you to supply your customers with panels machined and engraved to their specifications. Write today for our Dealer's proposition covering panels, dials, knobs and tubes.

Diamond State Fibre Company

Bridgeport (near Philadelphia), Pa.

Branch-Factory and Warehouse, Chicago

Offices in principal cities

In Canada: Diamond State Fibre Company of Canada, Ltd., Toronto

• MARBLE ANTENNA •

COMPLETELY replaces all ordinary wire aerials and outside wiring.

Connected to light-socket anywhere (alternating or direct current); fool proof and perfectly safe; uses no current, hence cannot blow fuses and will not interfere with Electric Lighting System.

Local static overcome and lightning proof; acts equally well with cheapest as with most elaborate instruments. A beautiful ornament suitable for office or library; taken anywhere it makes your Receiving Set useful at all times and in all places.





MARBLE ANTENNA COMPANY

MINNEAPOLIS, U. S. A.
510 N. Y. LIFE BLDG.

EDMONTON, CANADA
CATTISTOCK BLK.

"The Canned Aerial"

IN U.S.A. \$3.00
POSTPAID

CANADA \$4.00

Packed complete in box with instrument cords and 2-piece light socket plug. Full directions.

COPYRIGHT 1922



INSIST on Delaware Hard Fibre for all insulating parts on Radio apparatuses. It has high dielectric resistance, mechanical strength and adaptability of being machined into almost any shape. Photograph shows receiving set made from Delaware Hard Fibre.

"The Incomparable Insulation"
which we manufacture in sheets, rods, tubes and all kinds of special shapes.

DELAWARE HARD FIBRE CO.
WILMINGTON, DELAWARE

New York..... 50 Church Street	New Haven..... 209 Plymouth Building
Pittsburgh..... First National Bank Building	Boston..... 170 Summer Street
San Francisco..... 235 Pine Street	Philadelphia..... Fuller Building
Toledo..... 415 Ohio Building	Rochester..... 1040 Granite Building
Chicago..... 564 West Monroe Street	Dayton..... 314 Dayton Savings & Trust Bldg.

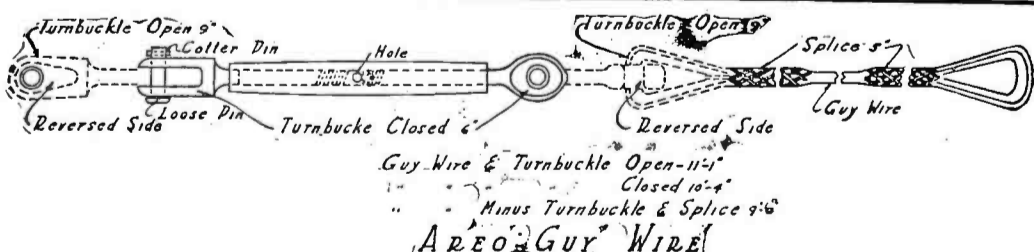

UNTIL our supply is exhausted, we are offering the above GUY WIRES for ANTENNA CONSTRUCTION. The turnbuckle is forged and machined and the wire, twisted and tinned, $\frac{5}{32}$ inch diameter. A WONDERFUL BARGAIN.

Price each, parcel post paid \$ 1.25
Per dozen, parcel post paid 13.50

Special quotation for large quantity. Ask for Prices on Hard Drawn Copper and Magnet Wire

HAVERSTICK & CO., 125 S. 5th Street, Philadelphia

**A 200 Watt A. C. Radio-
phone Transmitter**

(Continued from page 236)

the 5-watt tube. In the 5-watt tube circuit a 2-ohm rheostat was inserted in the filament side of the transformer to drop the voltage to eight at the tube. The high voltage transformer was a special type built for us. At 1,500 volts a load of 600 mils. could be safely drawn. The transformer was of the double winding type to work on both halves of the cycle and was tapped in the secondaries at 750, 1,000, 1,250 and 1,500 volts.

DESIGN AND ARRANGEMENT

In designing the instrument the following points were strictly adhered to: Neatness, symmetry, separation of circuits, proper spacing of wires, ruggedness and ease of control. By referring to the photographs it will be seen that the instrument is assembled in a heavy frame made up of angle irons. The overall dimensions are 5' 6" high, 24 $\frac{3}{8}$ " wide and 25" deep. Two full shelves are used, together with a half shelf. On the bottom shelf the complete power circuit is mounted. The high voltage transformer, the filament transformers and the filter condensers are mounted on the shelf, and close to the front are the four Kenotron rectifier tubes. The panel contains four portholes, through which the operation of the Kenotrons can be seen at all times by the operator. Above these portholes are the controls which from left to right are the amplifier filament rheostat, Radio filament tap switch, supply plate double tap switch and rectifier filament tap switch. Above each control is a meter to check each adjustment.

The half shelf holds the four 50-watt Radiotrons together with "local" grid resistances for each tube, the main grid leak resistance, grid condenser and two insulating condensers in plate and filament radio frequency circuit. These latter two condensers are for protection to the power circuit should the antenna and ground become shorted. The "portholes" for these tubes are cut directly above the voltmeters.

The upper shelf contains the balance of the radio circuit, voice circuit and also the relay circuit. The speech amplifier tube is mounted at the left. On the right side, near the panel, is the relay control circuit made up as one unit. The helix is mounted in back of the relay unit, together with the variable-tap condensers used in the antenna-grid circuit and also a series antenna condenser for working on low waves. The modulation transformer, modulator-amplifier coupling condensers, plate and grid reactors, resistance rods and "C" batteries are mounted back of the amplifier tube in good wiring order.

The panel is made up in two sections, the bottom one being 21 $\frac{1}{4}$ "x24 $\frac{3}{8}$ "x $\frac{1}{2}$ " and the top is 33"x24 $\frac{3}{8}$ "x $\frac{1}{2}$ ".

The panel is engraved in complete explanation of meters, controls, etc.

CONNECTIONS

All connections are made in back of the panel. Two terminal strips are provided, the top one for antenna, ground and receiver connections, the bottom one for the 12-volt battery, 110-volt A. C., 60-cycle supply, C. W. telegraph key, microphone and relay control wires.

The installation cost of this type of set is very low, as the 110-volt, two-wire line is the only power lead to the set. The batteries can very nicely be placed under the "lower shelf." The microphone and C. W. telegraph key are mounted on the operating table. The complete connections are provided for with an eight-wire cable.

All wiring in the set is done with No. 6 weatherproof wire. The covering is painted

Insure your copy reaching you each month. Subscribe to Radio News—\$2.50 a year. Experimenter Pub. Co., 53 Park Place, N. Y. C.

with glossy, black enamel to add to its appearance and for protection. Careful attention has been paid to separation of circuits and wiring so that a minimum of loss is accomplished. The wires are very rugged and as short as possible.

METERS

The meters, with the exception of the antenna meter, are all of the new type Weston, models 429 and 431, flush mounting. Two 0-15 volt A. C. meters are used for measuring filaments of Radio tubes and Rectifier tubes. An 0-10-volt A. C. meter is used to measure the filament of the voice amplifier. An 0-2000-volt D. C. meter with an external resistance as multiplier is used on the high voltage to measure the potential applied to the radio tubes. An 0-800 D. C. milliammeter measures the total plate current of all radio, modulator and amplifier tubes. An 0-150 D. C. milliammeter measures the grid current of the radio tubes. In the antenna circuit a Weston model 301 thermo-couple ammeter, 0-5, is used.

RELAYS

Three 20-ohm relays are used to actuate three power switches. These switches are each three-pole double-throw and are mounted up as one unit and controlled from the base of the microphone. It will be noted that no manual control switches are used (except a main power line cut off switch [fuse] that cuts off the main supply power feed wires to the set). One of the relay switches controls both sides of the 110-volt A. C. supply and one side of the storage battery supply to the microphone and is "dead" in the back position. Back positions are accomplished by mechanical springs so that power is consumed from the batteries only when the relays are worked. The second relay throws the antenna to the transmitter when relay circuit is closed. It also closes the plate and grid circuits of the tubes. On the back stroke the grid is opened first to prevent a heavy surge when antenna is broken. In the back position the antenna is connected to the receiver, leaving plate and grid circuits open. The third relay throws the modulators to the radio frequency circuit when I. C. W. is used and disconnects the microphone battery supply. In the back position, which is the "talking position," the grids and plates of modulator tubes are in modulating circuit and battery circuit is completed.

MICROPHONE

The microphone is a desk type; four switch buttons have been put in the base to control the power relays. One button acts as master and will trip as many relays as are "set," and the remaining three are "sets." Each one operates a relay. An example of the efficiency of this method is received from the following: If I. C. W. telegraph is desired, three relays will have to be thrown. These buttons are pushed down and automatically "set," then the full control is effected by pushing and releasing only the master during complete operation. When the voice is used only, the power and antenna transfer relays are "set," etc. Inasmuch as A. C. is used, this is the quickest change-over from transmitting to receiving possible. When receiving, the transmitter is completely DEAD. The power is available instantaneously.

FILTER

Regarding the filter system, which has made this set so effective, the following points are enumerated: (a) Referring to the schematic circuit it will be seen that a two-coil transformer is used as a filter. These coils are two henries each. The first important thing of note is that higher capacity is used on the high voltage transformer side of the circuit. New type condensers are used in series parallel. It was found that the most effective filtration was accomplished by having this side high. Additional capacity on the Radio side of the filter transformer was hardly noticeable. One-half

ANNOUNCING THE RADIO



A combined Phonograph and Receiving Set at a medium price. The Playerphone is known as one of the highest grade Phonographs on the market, and with the splendid standard Two-Step Receiving Set installed in connection, it affords the Music Lover and Radio Fan a most wonderful instrument.

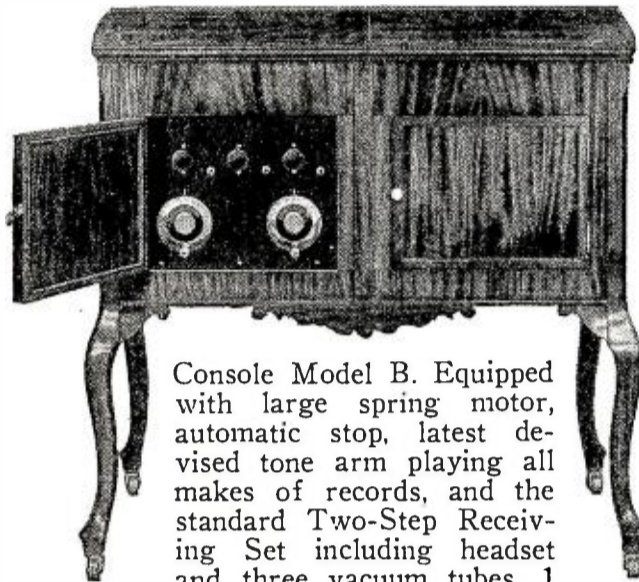

Console Model B. Equipped with large spring motor, automatic stop, latest devised tone arm playing all makes of records, and the standard Two-Step Receiving Set including headset and three vacuum tubes, 1 Detector and 2 Amplifiers. List\$250.00



This Exclusive Radiophone Desk made especially for Radio Sets, equipped with Standard Radio Receiving Set including headset and three vacuum tubes. List.....\$185.00

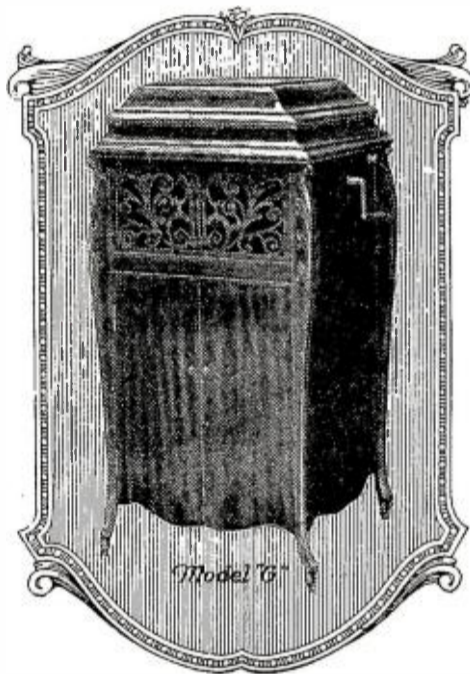

High Grade, Genuine, Mahogany, Beautifully Finished Upright Cabinets from \$50.00 to \$150.00. Prepared with compartment underneath horn for your Radio Outfit. With complete Phonograph equipment, \$25.00 to \$50.00 extra.



This large, magnificent White House Model Playerphone, the very finest on the market, all metal parts gold trimmed, equipped with large four spring motor, latest devised tone arm playing all makes of records and the standard Two-Step Receiving Set, including headset and three vacuum tubes. One Detector and two Amplifiers. List.....\$600.00

Complete Standard Radio Set, like shown in Console model B, installed in a 12x13 beautiful mahogany Radio Cabinet equipped with headset and three vacuum tubes. List.....\$125.00

Radio Fans building their own sets can buy cabinets of any size from us or any of the above phonograph cabinets at a reasonable price.

Excellent proposition for Agents and Dealers
Independent Radio Appliance Co.
 111 North Market St.,
 Chicago, Illinois

MARKKO



"The Mark o' Quality" for **RADIO**

ALWAYS DEPENDABLE

Made in All Sizes and Capacities

Guaranteed Two Years

Marko Storage Battery Company

1402 Atlantic Ave. Brooklyn, N. Y.

Jefferson Ave. at Bedford



HIPCO Multiphone



Buy a Hipco Multiphone

Price \$5.00 Complete With Four Sets of Head Phones

Let Your Friends and Family Listen in—Reproduction 100% Perfect. No Trouble—Nothing to Get Out of Order.

The Hipco Multiphone enables you to purchase four pair of receivers for less than the price of one. Reproduction 100% perfect—no trouble—absolutely nothing to get out of order. Your family or your friends may now enjoy radio concerts, lectures, etc., with perfect ease and comfort to all.

The Multiphone may be used in connection with any receiver. Simply place one of your receivers face down on Hipco Multiphone and draw the elastic bands over back of receiver to hold it firmly. The Multiphone will do the rest in a most pleasing manner.

HIPCO WIRELESS B BATTERY

Refillable	Variable
No. 140—22½ Volts,	\$2.00
Price.....	
No. 100—22½ Volts,	\$3.00
Price.....	

FOR SALE AT ALL RADIO SUPPLY DEALERS

Manufactured by
HIPWELL MFG. CO. N. S., PITTSBURGH, PA.

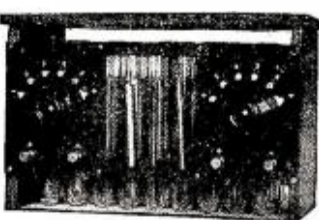

STORAGE BATTERIES

Designed Especially For

WIRELESS



KICO nickel-iron type alkaline storage "B" batteries have long since passed the experimental stage. The purchase of one will solve your "B" battery troubles for years to come. They are not harmed from short-circuiting, overcharging or standing idle, last from three to six months on one charge and can be recharged from A.C. with rectifier furnished with each battery. Money back if unsatisfied within 90 day trial. Plain batteries with clips for adjustment

22 volts, \$6.50; 32 volts, \$8; 48 volts, \$10; 68 volts, \$12. Batteries with panels and switches for adjustment as per cut, 32 volts, \$12; 48 volts, \$14; 68 volts, \$17.
For "A" battery comfort buy a KICO 60 A. H. battery complete with rectifier to charge from A.C. at the following prices: 6 volt, \$19; 8 volt, \$22; 10 volt, \$25. Literature gladly furnished.

KIMLEY ELECTRIC CO., 290 Winslow Avenue, BUFFALO, N. Y.

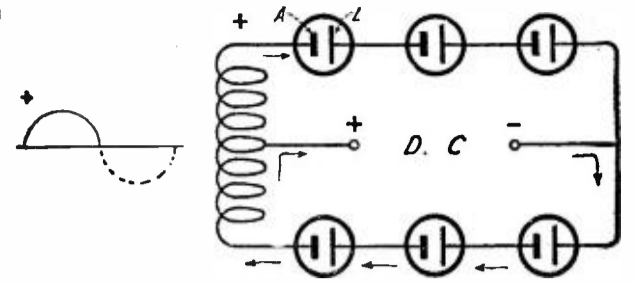

Fig. 6-A

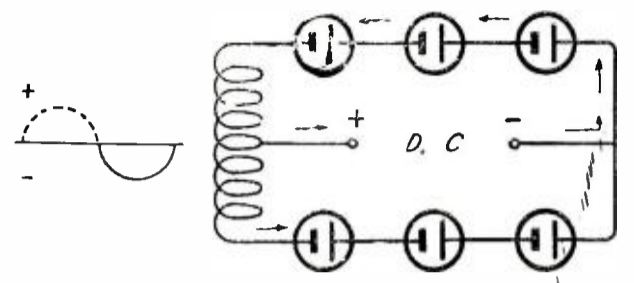

Fig. 6-B

The Operation of an Electrolytic Rectifier is Shown by the Arrow, Indicating How the Current Flows for Each Half Cycle

strips can best be secured to the wood piece by making use of old battery binding posts, as shown.

The present plan is to obtain full wave rectification and the circuit used for obtaining this condition is shown in Fig. 6, "A" and "B."

By following the arrows in the drawings "A" and "B" of Fig. 6, it will be an easy matter to understand how the rectifiers work towards rectifying both sides of the cycle or full wave rectification.

One jar for every 70 volts used in the high voltage circuit should be allowed. However, it will be even better to allow but 60 volts for each one. More efficient operation, due to lack of heating troubles, will be the result. There is no objection to allowing but 10 volts for each jar. Better results will be obtained, but the number of jars will have increased to such proportions that the whole outfit will be in the way and it is a very dirty affair.

FORMING THE PLATES

This is the meanest job of all. It takes from two to three hours to form the plates. The jars are connected as shown in Fig. 6 and before they are formed they act as a short circuit to the secondary winding. This causes the windings to heat considerably. For this reason the current should not be applied to the jars for more than 15 minutes. Permit the secondary winding to stand idle then, until cool.

The plates are formed when the aluminum plate sparks over its entire surface.

Note that in this circuit the center tap of the secondary is positive instead of being negative, as was the case when rectifier tubes were used.

With the rectifier tubes on a 350-volt secondary circuit, the author found it possible to obtain as high as 180 milliamperes.

New Broadcasting Stations

- KDZM—E. A. Hollingworth, Centralia, Wash.
- KDZQ—William D. Pyle, Denver, Col.
- KDZK—Nevada Machinery & Electric Co., Reno, Nev.
- KDZP—Newbery Electric Corp., Los Angeles, Calif.
- WEAG—Nichols-Hineline-Bassett, Edgewood, R. I.
- WEAM—Borough of North Plainfield, N. J.
- KDZL—Rocky Mountain Radio Corp., Ogden, Utah.
- KDYX—Star Bulletin Publishing Co., Honolulu, T. H.
- WEAH—Wichita Board of Trade & Landers Radio Co., Wichita, Kan. (Also weather and markets.)

A welcome addition to your library! Send \$2.50 today, plus postage for 7 lbs., and your copy of bound volume No. 2 of Radio News will come forward by return mail. Experimenters Publishing Company, Inc. 53 Park Place, New York City

microfarad is used as the final capacity there, and one and a half on the transformer side of the circuit. (b) The new feature of this filter system, and really the most important, is the condensers shunted across the coils. This was discovered by the writer and is very effective. It is a TUNED circuit, apparently to a harmonic of 60 cycles. In the case of filter coils used, a one-microfarad shunt was found to be the proper value. Higher or lower values had the effect of throwing the A. C. out of phase. While experimenting with this, having set radiating and listening to A. C. in wavemeter, one side of line was built up in steps by multiple condensers. As condensers were added, the peak voltage of the loaded side, as applied to the Radio tubes, was apparently shifted from a direct right angle until a peculiar off-phase hum or "beat" was observed. When this circuit is tuned properly, the filtering will be very effective. It is found that this method cuts down the necessity of having high condenser capacity across the line as ordinarily used. The voltage across the coils is much lower than that across the line, thereby reducing the number of condensers used by "series-paralleling." (c) It is important when two iron core filters are used and clamped together as a unit, that they must be poled properly. (d) The A. C. is given further filtration in the modulator tubes by inserting individual resistance rods, 1,000 ohms, in each grid circuit. By reference to the schematic it will be seen that these are in series with grids. (e) The plate and grid reactors and also resistances of modulator and amplifier tubes also aid in the filtering. (f) It was noted that when the proper filtering was accomplished the complete transformer circuit became very quiet. This condition was chiefly brought about by the tuned filter system mentioned in "b" and proper capacities in "a."

It is hoped that this article will help those using A. C. radiophones. An A. C. phone, if properly filtered, is highly desirable, because of its flexibility and ease of control and also by the fact that it has just as sharp a wave as generator sets and is not a "QRM hound." It is admitted that there are many A. C. sets not accomplishing good results that are creating enemies every time they open up. Instead of enemies our set has made many friends, while operating on test at 2BB. After further tests are completed the set will be used regularly by Station 2BQH, located at Mamaroneck, New York.

Potash and Perlmutter Discuss This Here Radium Broadcasting

(Continued from page 254)

ing machine like you used to, y'understand."

"I wasn't insulting you, Abe. I was only warning you," Morris assured him. "Which if you've got an idea that you would like to buy one of them radium receiving outfits with a storage battery strong enough so you could hear *The Rosary* from as far away as Chicago, Abe, put it off till after the buyers has gone back in August, because if I've got to run this business alone for a while, I would feel a whole lot better if you was in the hospital for something legitimate like being run over by a taxicab, instead of monkeying with a toy like this here radium outfit."

GARFUNKEL'S POWER PLANT

"Say!" Abe exclaimed. "You should not worry your head that I'm going to invest any more money in home amusements. I've got several hundred dollars tied up right now in a phonograph and a self-playing piano which ain't neither one been operated by either Rosie or myself in over eighteen months already on account of overdoing it when we first had them, y'understand."

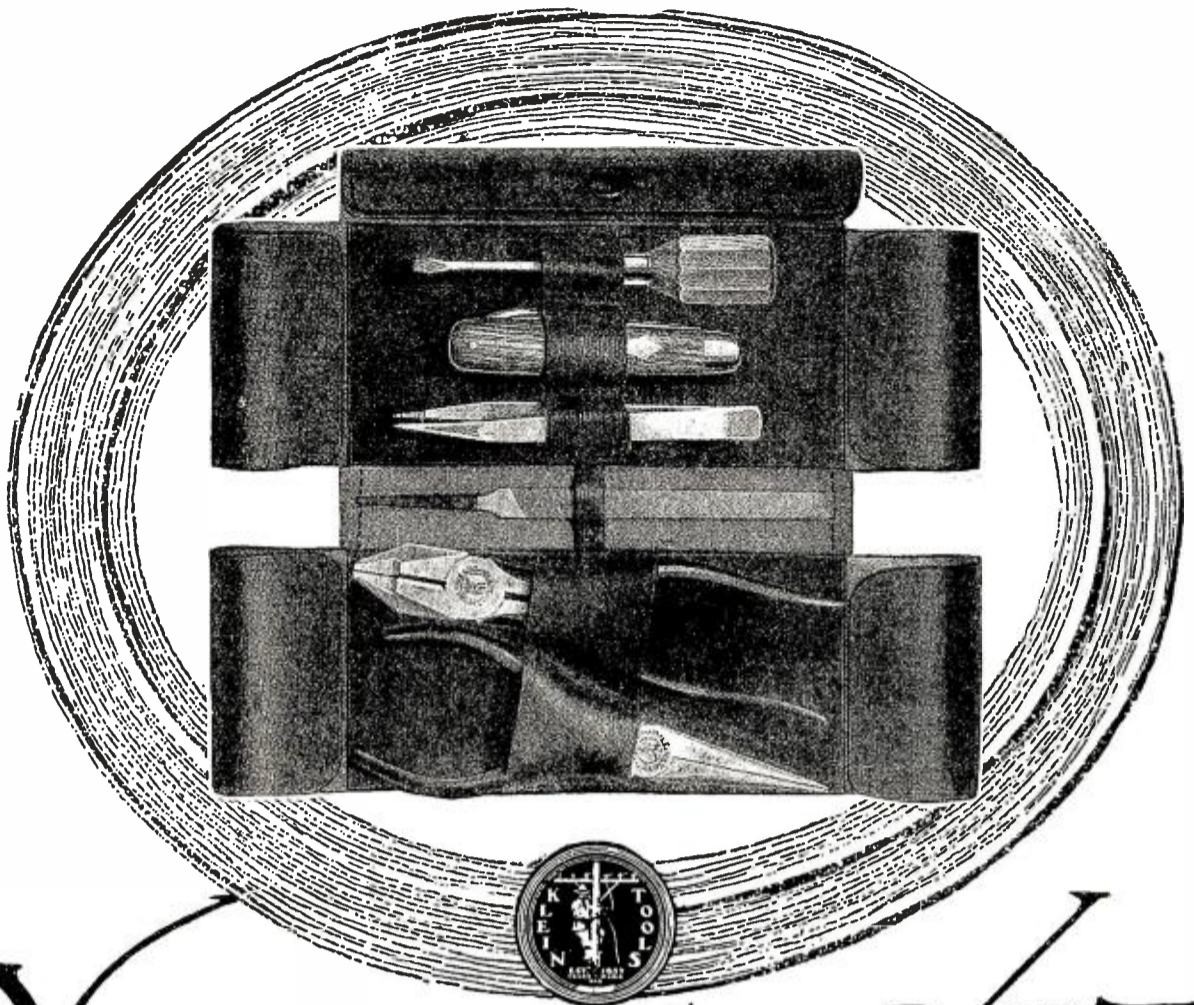

You need this KIT now!

Here's the pocket radio kit you've been looking for. Made up by radio engineers for radio engineers. No plaything—the tools are Klein quality, that have been standard with electricians and telephone and telegraph men for 65 years—they will last for years!

The Klein radio kit includes one fine Klein 5-inch long-nosed plier, one Klein 6-inch side-cutting plier, one Klein electrician's knife and the best quality of small screw driver, electrician's tweezers and a flat safety file. The whole assortment is put up in a full leather, hip pocket folding case.

A Beauty! Remember—M. Klein & Sons tools have been standard with American telegraph and telephone companies for over half a century—every Klein tool is guaranteed.

Get the Klein Radio Kit today from your hardware or electrical dealer, or send \$7.50 with the name of your dealer, to us.

Mathias KLEIN & Sons
Established 1857 Chicago, Ill. USA

3200 Belmont Ave., Chicago

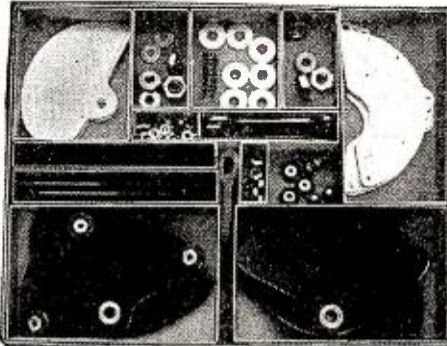

Build Your Own Condenser —and Save Money

Purchase material for any size
MARSHALL VARIABLE CONDENSER
you wish. Condenser comes in knock-down form, complete with instructions for assembling.
Pride yourself on your own handiwork—satisfy yourself with the saving in cost.

Front and back plates of selected hard rubber. Central mandrel, adjusted through one or more cone bearings, turns in brass bushing. Plates and separators of especially prepared highest quality aluminum.

CANNOT GET OUT OF TRUE

MARSHALL CONDENSERS FULLY ASSEMBLED or READY TO BUILD

Note substantial savings on this quality radio equipment

No. of Plates	Price, Assembled	Price, Ready to Build	No. of Plates	Price, Assembled	Price, Ready to Build
3	\$2.50	\$1.90	23	\$5.25	\$3.80
5	2.75	2.10	35	6.00	5.15
9	3.50	2.55	43	6.50	5.80
17	4.25	3.35	67	10.00	8.40

TO FIGURE CAPACITY: Divide capacity you need by .000041 MFDs to get the number of outer plates needed to build your set. Add one extra outer plate for any fraction in the answer

Order at once from your dealer or direct if he cannot supply you. Illustrated circular on request.

NEW HAVEN RADIO COMPANY, Mfrs.
Chapel and Hamilton Streets New Haven, Conn.

CHARGE 2 BATTERIES IN YOUR HOME AT THE SAME TIME FOR

Keep Your Batteries Charged

The HULBERT Battery Charger will charge two batteries at the same time, in any of the following combinations (an Automobile and Radio "B" batteries—or Radio "A" and Radio "B" batteries), at a cost of about 5 cents. And merely by connecting the HULBERT Battery Charger extension cord to any 110 Volt Alternating Current electric lamp socket in your office, home, garage, basement, etc.

Your automobile battery can remain right in the car—just connect the HULBERT Battery Charger to a lamp socket in the garage and the Battery Charger extension to the battery, turn on the "juice" before retiring at night—your battery is fully charged when you get up in the morning. It's just as simple as that.

By a New Electrical Principle

The HULBERT Battery Charger represents a new departure in the construction of transforming and rectifying devices which are combined in a single unit. It involves an entirely new electrical principle. Practically no adjustment is required. The charger is self-polarizing; so battery can be connected either way; except when two batteries are being charged at the same time. The charging rate adjusts itself automatically to the type and condition of the battery charged; charging from twelve to five amperes on the six volt batteries and one-half to one-quarter amperes on the ten to twenty-five cell battery. No adjustment is required ordinarily; but if it is, one screw does the whole thing.

The Advantages of the HULBERT Battery Charger

1. Simplicity of Construction.
2. Only one moving part.
3. All parts visible.
4. No permanent magnets.
5. Self-polarizing.
6. No springs.
7. Two batteries charged at the same time.
8. Heavy construction, insuring dependable operations.

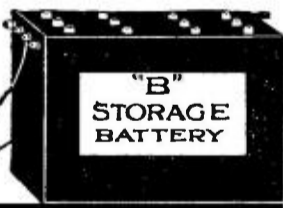
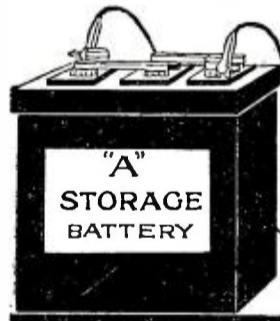

The Hulbert Electric Mfg. Co.

710 N. Ashland Ave., Chicago

10 Days FREE Trial

Order a HULBERT Battery Charger TODAY. Enclose your check, postoffice money order or draft for \$20.00 with your order and it will be promptly shipped, furnished with 10-foot lamp cord and standard lead-plated battery clips attached; a 5-foot lamp cord with nickel-plated battery clips attached for "B" battery; and a 5-foot lamp cord with attachment plug.

All instruments and adjustable parts mounted on beautifully finished fibre panel board to match your radio set. Try it 10 days. Give it the hardest test you can. Convince yourself that it is everything claimed for it. If you are not entirely satisfied, send it back and your money will be promptly returned to you. YOU CAN'T GO WRONG. This guarantee is positively unconditional. Don't be without one. ORDER YOURS TODAY.

FREE A clear descriptive folder, that tells the whole story; with a sketch drawing of this new electrical principle and how it operates. Printed so you can understand it. A postcard with your name and address will bring it to you FREE. Send for one TODAY.

DEALERS Write on your business letter-head for our attractive DEALERS OFFER. This is a quick, profitable seller.

"So, therefore, Mawruss, if me and Rosie in only a few months' time lost the ambition to work such a regular sinecure as a mechanical piano or a phonograph, you could imagine how long it would take us to lose interest in one of these here radium outfits where you've got to be a combination of Henry Ford and Thomas J. Edison to get the best results out of it.

"Take that machinery which Garfunkel has got in his living room, Mawrus, and the way it looked to me last night, y'understand, there was enough of it to run anyhow a medium size garment factory. If I had such a power plant in my living room, Mawruss, the least I would expect to hear over it would be the entire Metropolitan Opera House company in an All Star production of *Parsifal*."

"Well, these here radium broadcasting stations ain't being run for such first-class A number one patrons of high grade music like you, Abe," Morris said. "The idea is that the stuff sent out should appeal to all kinds of people, and while I admit that I don't exactly see where more than one thousandth of one per cent. of the people who buy receiving apparatus are going to be interested in a lecture on *Our Water Supply and How We Paid For It* by the Mayor of Paterson, N. J., y'understand, at the same time the average citizen would be a whole lot less bored by such a lecture than he would be by a performance of *Parsifal*."

WHAT DOES THE FARMER WANT?

"Also, Abe, it ain't only music that these here radium broadcasting stations is broadcasting," Morris continued. "The idea is to increase the sales of receiving apparatus among people which has got such a poor ear for music that they would sooner hear what *Kennecott Copper* closed at or who won the fourth race at Tia Juana than a whole orchestra of Kubeliks."

"But I thought it was the farmer and not the city man that was going to get the most benefit out of this here radium broadcasting," Abe said, "and after a hard day's ploughing, Mawruss, what amusement is it going to be for the tired farmer to sit around the farm house kitchen and hear that *Tombstone Tire and Rubber* went up to a quarter bid three-eighths asked, and then broke to one-eighth, or that there was especial weakness in German rates, the mark being quoted at three-tenths of a cent—cables?"

"Well," Morris remarked, "what the farmer needs nowadays is not so much amusement as consolation, Abe, and it must be anyhow a consolation for the farmer to find out that in this year of 1922, farming ain't nearly in such a bad way as Foreign Exchange."

"Or Cloaks and Suits neither," Abe concluded.

Copyright, 1922, The Bell Syndicate, Inc.

Advertising by Radio—Can It and Should It be Done?

(Continued from page 232)

In the sporting field, the hearing of the reports from the baseball diamond; play by play, and inning by inning; will not keep people away from the game. On occasions they will take their reports in this fashion, particularly, if confined in a hospital, or at home, indisposed, or too far away to get to the ball grounds. However, the listening by radio will intensify a desire to be present at another time. I might go on to enumerate, but I think it is unnecessary to do so. It is clear enough, I think, that the radiophone will simply supplement the newspaper work, and entertainment work of all kinds, and is not an agency to fear, but rather one to make use of in the right way.

Amusement promoters, singers and other artists were alarmed when the phonograph was introduced. However, as we all know, there was no need for alarm because the phonograph has actually stimulated business

EXPERIMENTERS:

The following are the per pound prices on enameled wire delivered to you, no charge for postage or spools. If you need any other insulation write for special price list.

No. 14.....51c	No. 23.....71c	No. 32.....\$1.00
No. 15.....52c	No. 24.....73c	No. 33.....1.04
No. 16.....53c	No. 25.....76c	No. 34.....1.08
No. 17.....55c	No. 26.....78c	No. 35.....1.14
No. 18.....62c	No. 27.....81c	No. 36.....1.20
No. 19.....64c	No. 28.....84c	No. 37.....1.35
No. 20.....65c	No. 29.....88c	No. 38.....1.55
No. 21.....67c	No. 30.....92c	No. 39.....2.00
No. 22.....69c	No. 31.....96c	No. 40.....2.75

Immediate delivery. No order accepted for less than one pound, or less than \$1.00

AMERICAN ENAMELED MAGNET WIRE CO.
MUSKEGON, MICHIGAN

HAVE YOU SOMETHING TO SELL OR EXCHANGE ?

A classified ad in Radio News will reach over 235,000 at a cost of only fifteen cents a word

for the theatres and other entertainment enterprises.

People, hearing the reproduction of voice on the phonograph, are impelled, when they can, to go to hear and see the artist.

We now arrive at the most important point of our discussion. If radio broadcasting is an agency that is rendering, and can continue to render, valuable service to the people, it must be protected. You remember the old song:

"Everybody's doing it,
Everybody's doing it,
Everybody's doing it now."

When there were few stations broadcasting from widely separated centers, the reception was satisfying; at least, there was little to disturb outside of the natural static conditions. However, quickly one sending station after another has been started and today there are all over the country pretty close to 100 stations putting out programs, if not nightly, occasionally.

It is clear, I think, that since all these stations are on the same wave-length, 360 meters, there is bound to be increasing confusion and that a Government regulation of wave-lengths is positively imperative to maintain the efficient service of radio broadcasting. This control of the use of radio is in the hands of the Department of Commerce, now giving careful consideration to the general subject, and there is now recommended a band of wave-lengths for radio broadcasting for the purpose of avoiding experiences of recent months of three and four stations broadcasting simultaneously.

However, irrespective of all this, let us come to the real subject of advertising by radio. Can it be done, and should it be done? Already the conference that has been in session in Washington to consider the proper regulation of radio broadcasting has recommended the prohibiting of advertising by radio. It is perfectly natural that this ruling should be made at this time, because if advertising were permitted, it goes without saying that all the good work that has been done in giving valuable information and pleasant entertainment for the people would be destroyed. This action of the committee is at this time very necessary, and those who have been enjoying radiophone service will surely appreciate the necessity for such action.

Let us think of the billboard for a few minutes. Why is it that the billboard has always had trouble? From the beginning there have been those who would remove it from the face of the earth. I think the answer is that somehow or another the billboard has been offensive to the people, and even though billboard promoters have raised the art to an exceedingly high standard, even in the face of this, billboard sign work is always in trouble with local and state associations.

We all know how persistently the advertising man has worked to get free advertising through the movies, and we know that it is pretty generally true that he hasn't secured it. The reason is well known. The public will not stand for direct advertising when they go to see high class moving pictures.

Let me ask you whether the public will wish advertising to come to them through the agency of radio broadcasting. Remember that this advertising will go right into the home. It will invade the place where the family is enjoying the full benefits of privacy and detachment from business cares. The broadcasting to thousands of homes of advertising information concerning, say, "Things for women and things for men," probably the butcher with his meats; the baker with his bread; the tailor with his clothes, and the grocer with his crackers and cheese—what kind of a home will it be anyhow? You may say you can turn it on at will and turn it off when you want to, but even so, who will want it? How valuable will be the media if the public will not support it? Personally, I don't think they will support it.

BURGESS "B" BATTERIES

BURGESS "B" Batteries assure clear receiving, increase the efficiency of any receiving set, and they are cheapest in hours of service.

BURGESS "B" Batteries are sold by every progressive Radio Dealer and Jobber. "Look for the Black and White Stripes."

A postal card from you brings full information by return mail. Why not write to us today?(Dept. C)

BURGESS BATTERY CO.

Offices and Warehouses:

CHICAGO 111 W. Monroe St. NEW YORK 50 Church St. BOSTON 136 Federal St.
MADISON Wisconsin 2109 Grand Ave. KANSAS CITY 2362 University Ave. ST. PAUL

In Canada: BURGESS BATTERIES, Ltd.
WINNIPEG TORONTO MONTREAL

The BURGESS "B" batteries illustrated are the most popular now in use. We manufacture all types—detailed information on request.

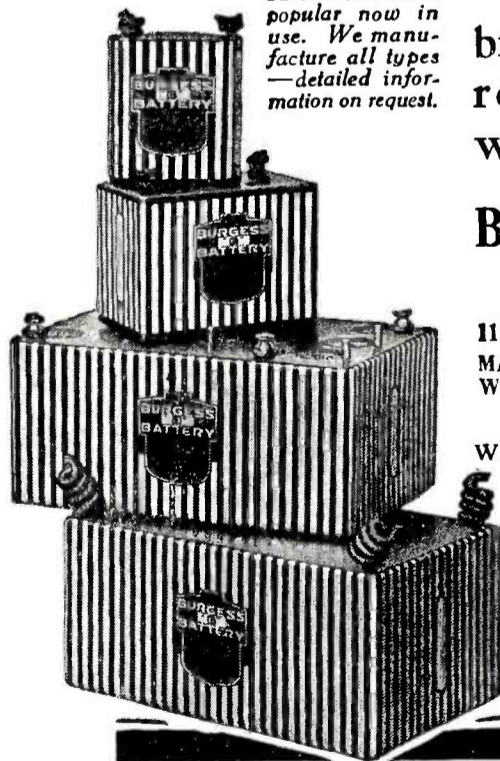

OVER 300,000 SOLD—WHY?

"ASK ANY RADIO ENGINEER"



KING
"Am-PLI-tone"

*f*or Summer Concerts, News and Dancing, use the KING "Am-PLI-tone"; the accepted standard. It has **true tone and volume**—no sheet metal is used—the "TINNY" SOUND is left out. Polished cast aluminum body with nickel-plated base and bell.

Pats. Pendg.

The volume is **doubled** because TWO head phones are blended into one **POWERFUL** tone. Scientifically correct.

"It Speaks for Itself"

At all leading Dealers—Price \$12, f.o.b. N. Y. City

KING "AM-PLI-TONE"
82 Church Street - - - New York City
(Warning: All infringers of this device will be vigorously prosecuted)

RADIO SUPPLIES

100 ft. Aerial Wire.....	\$0.35	Crystal Detectors.....	\$0.75
Switch Levers.....	.25	Phone Condensers.....	.35
Switch Points, per dozen.....	.30	Tested Galena.....	.15
Lightning Arresters.....	1.00	Insulators.....	.20
Arkay Loud Speaker Horns....	5.00	2200 Ohm Receivers, pr.....	8.00
Rotors.....	.35	V-T Tube Sockets.....	.75
Variable Cond. Plates, ea.....	.03	3-inch Bakelite Dial.....	.85
Tuning Coils.....	3.50	Detector and 1 Step Amplifier.	32.00
Ground Switches.....	3.15	7-strand No. 22 Aerial Copper	
Variable Condensers.....	1.25	Cable, 100 feet.....	.75
B Battery, 22* volt.....	1.95	Sliders.....	.25
Variometer Blocks, complete...	1.50	Jacks and plugs up from.....	.40
Binding Posts.....	.05	Test buzzers.....	.65
1/4 in. Sq. Brass Rod, ft.....	.10	Formica Panels, all sizes, 65c up.	
3-16 in. Sq. Brass Rod, ft.....	.05	All sizes Magnet Wire.	
Variometers.....	5.00	2-Step Amplifiers.....	37.50
Varicouplers.....	4.50		

WHOLESALE AND RETAIL

IZENTARK RADIO CO.
FORMERLY CHICAGO SALVAGE STOCK STORE
509 SOUTH STATE STREET, NEAR CONGRESS
WRITE FOR OUR ATTRACTIVE PRICE LIST

3 YEARS' UNCONDITIONAL GUARANTEE (in writing)

U.S. Storage Batteries For Radio, Telephone and all other uses

6 Volts, 20 Amp.....	\$7.50	6 Volts, 80 Amp.....	\$12.50
6 Volts, 40 Amp.....	10.00	6 Volts, 100 Amp.....	27.50
6 Volts, 60 Amp.....	13.75	8 Volts, 60 Amp.....	18.00

Recent radical improvements make it possible to guarantee Batteries shipped after June 15 for 3 years

STORAGE B BATTERIES GUARANTEED 1 YEAR
9 Cell, 22½V, \$7.50 — 20 Cell, 50V, \$13.75 — 40 Cell, 100V, \$26.50
If your dealer hasn't it, send money order or check direct. Orders promptly filled

Distributors — Jobbers — Dealers — Write for Discounts
U. S. STORAGE BATTERY CO., Far Rockaway, N. Y.

KRL **RADIOFREQUENCY CONTROL PANELS**

Radiofrequency control units of compact design consisting of polished formica panel which is fastened to 3/8" bakelite base of high grade tube receptacle, with nickel plated phosphor bronze contacts. Fada rheostat and 8 binding posts are conveniently arranged on panel 4 3/8" x 2 3/8". Radiofrequency transformer is mounted on formica base to the rear of the socket. No wood is employed. Heavy bus bar wiring, protected by spaghetti tubing. Units may be harmoniously combined to form several stages of amplification. Wired with ALL AMERICAN radiofrequency transformer, \$10.50; with MURAD T-11, \$12.00. Dealers' discounts on request. Immediate delivery on Baldwin phones, vacuum tubes, Magnavox, Clapp-Eastham HR sets.

THE KEHLER RADIO LABORATORIES, Dept. R. Abilene, Kans.

Advertising must ride on some service, and in riding on that service it must not destroy the service. The editorial page of a publication pretty generally determines the quality and extent of the circulation. Therefore, the value of a medium for advertising must play second fiddle to the editorial and written pages. It is, therefore, true that advertising must "stand by" until it finds a way to associate itself with radio broadcasting without, in any way, destroying the refinement and enjoyment and general satisfaction that comes from receiving news bulletins, baseball scores, lectures, sermons, bedtime stories, concerts, etc., etc.

Has advertising been tried by radio? In our own case, at the beginning of our broadcasting work we mentioned, for a short time, heating appliances and those things made by us that generally appeal to the public. We very soon found out that the people revolted at this sort of thing. They felt that we were cheapening something that was well worth while. This came to us so forcibly that we quickly dropped it and we have not been advertising anything, not even our radio apparatus, in connection with our broadcasting work.

I recall one experience that came to me shortly after trying out advertising by radio. One day last year when I visited Indianapolis and met a number of business men there, I was quizzed a great deal about radio broadcasting, and I told them something of the starting up of the "mother" station, KDKA, at Pittsburgh as a regular broadcasting station. One of the business men present asked for the privilege of telling of the experience he had had, and this being granted, he described a visit he had made to Chicago to buy a Westinghouse receiving set with all supplemental equipment. He pictured his return home and the work entailed in putting up the aerial and connecting up the battery, and that sort of thing. Then he explained that the first thing he heard was: "Electricify your home and make it modern for good housekeeping. Use electric ranges, coffee percolators, toaster stoves, and electric irons. If you are interested in a standard of quality, ask for Westinghouse."

"Now," said the speaker, "for all of this I went to Chicago and spent several hundred dollars and a great deal of my time to install it, only to get some advertising matter."

Of course, my friend told this half in jest and half in earnest, and yet it proved to me that advertising was the thing that would not easily find a welcome in the radiophone program, and our company, since that time, has omitted advertising from its broadcasting program.

There is a kind of advertising, however, which for want of a better term may be called "collective and educational," which, if properly censored, may be made a part of radio broadcasting programs; for example, talks on styles for women, the well dressed man, sanitation, the value of a photograph, etc. Addresses of this kind, not inspired by any particular institution, but given out unselfishly, naturally develop an increase of business. Some work of this kind has been done and I believe the public will support this sort of thing.

In closing, I give as my opinion that advertising must be inoffensive to the public and any advertising that enters the home must be welcome. If it is in any sense an intruder, it will fail just as an agent at the door is turned away if his appearance or manner is objectionable.

Radio to Supplant Universities?
(Continued from page 232)

per." Every Friday at 8:45 p. m., at the close of the weekly radiophone concert, special features and general items of interest

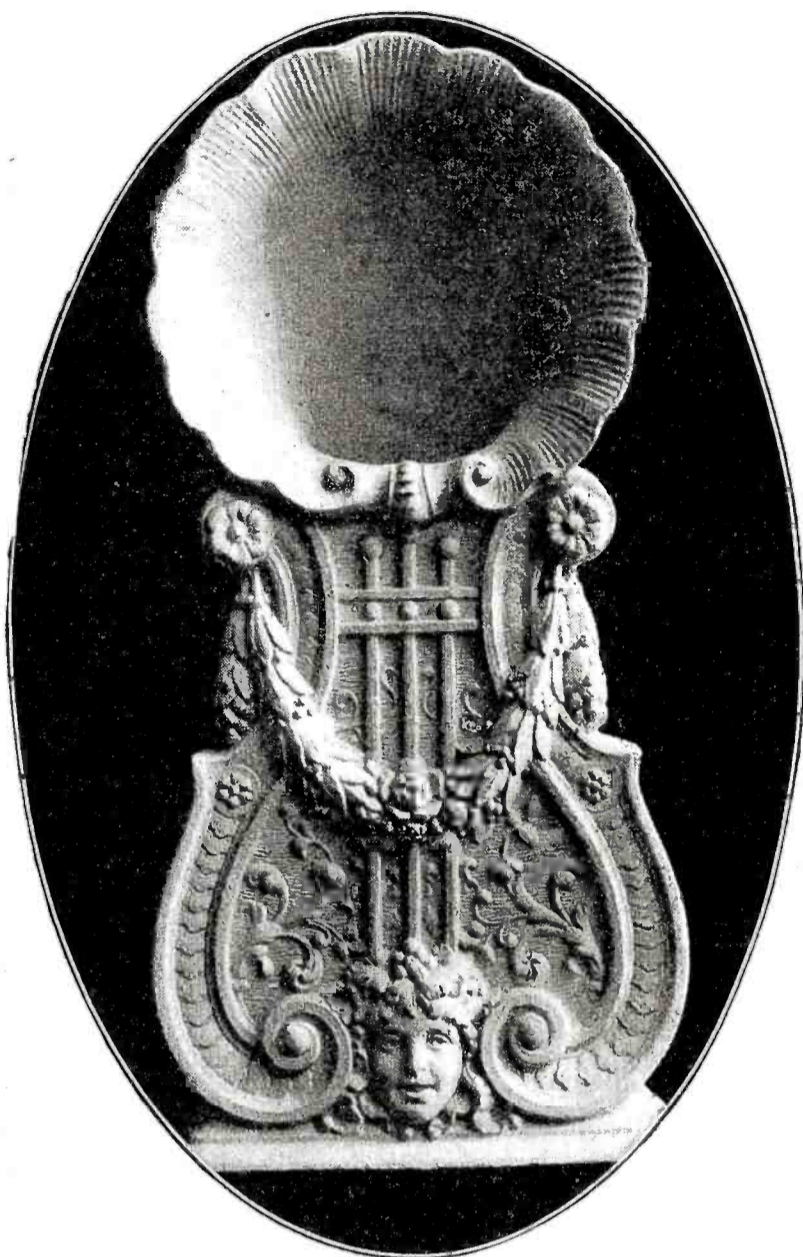

“MADERA”

Clearspeaking HORN and CABINET

Made of Die-Cast Wood

A Delight to Both Eye and Ear

Brings out the soft, distinctive *semi-tones* of the human voice and lends to music a rich, full tone quality impossible with metal horns. It absorbs and destroys all jangling sounds and makes clearly audible messages that are otherwise unintelligible.

Horn is separate from, and sets loosely in, the Cabinet. Is equipped with attachment for holding any type of Phone Receiver. Wire connections enter back of cabinet out of sight. Both Horn and Cabinet are die-cast from wood fibre under great pressure, accompanied by an electric baking process. This forms thin walls of a very dense wood, possessing remarkable acoustic properties. So thin are these walls that the entire Cabinet and Horn weighs only 5 lbs., yet so strong it will bear a man's weight.

Height over all 20 in. **\$25⁰⁰**
 Horn, 10 in. diameter. Price,
 boxed, ready for shipment . . .

Send for an outfit. It will add a new and unexpected joy to your Radio parties. Send cash with order. Money will be refunded on return of outfit if found unsatisfactory.

Circular for the asking

American Art Mache Co.
 6307 NO. CLARK ST. CHICAGO

CASTINGS

Brass, Bronze, Aluminum

Our Motto
“SERVICE”

The Anchor Brass & Aluminum Co.
 Ninth and Freeman Sts. CINCINNATI, OHIO

APPARATUS HEADQUARTERS

Special Parado Offer No. 5 (Retail Only)

This complete outfit will give you a receiving set with 2-step amplifier with a range of 1,000 miles. It includes Parado Offer No. 1 advertised in the January Radio News, and Parado Offer No. 2 advertised in the March Radio News.

Complete Parado Receiving Set No. 1 **\$36.60**
 Complete 2-step Amplifier Set No. 2 **31.60**
 Entire Outfit, Parado Offer No. 5... **\$68.20**

NOTE—You can order both sets or either at the above prices.

Complete instructions for assembly and connections furnished **FREE** with order.

Write for other combination offers and FREE PRICE BULLETIN

Special Dealer Plan

Dealers:—Write for our new plan on distribution. We are taking orders on monthly allotment basis. Our dealers and agents get the best lines of equipment. We distribute these lines:

**Acme Clapp-Eastham Grebe
 Adams-Morgan DeForest Moorhead
 Baldwin Jewell Murdock
 Brandes Federal Pacent
 Westinghouse Radio Corporation**

Write today for New Dealers' Discount Schedule No. 8



Peoria Radio Sales Co.
Dept. B
PEORIA, Illinois



KLAUS RADIO CO.
Dept. 200
Eureka, Ill.

FIRST TESTED THEN SOLD

are being sent out by M. P. Hanson, operator of the University station. In addition to this, Wisconsin is co-operating with other schools to exchange student news for their respective college publications.

Thomas A. Edison, in a recent interview, said: "There is no limit to the possibilities of the radiophone's development. Thanks to amplifying devices, the dropping of a pin in New York can be distinguished in San Francisco. This means the spread of information on a hitherto unparalleled scale, drawing every home in the land into the radiophone's educational influence.

Agreeing with Mr. Edison is Dr. Goldsmith, director of the research department of the Radio Corporation and in charge of the radio work at the City College of New York, who believes in the coming educational features of wireless. He says in a recent issue of the *New York Globe*: "Radio broadcasting will provide the school, the theater, and the lecture platform of the future."

With such an outlook being advocated by the country's leading scientists, the effect of this new form of communication can readily be seen on the building programs of our state Universities.

For years the great increase of students has taxed the teaching facilities of the United States to the utmost. Ohio State University, alone, will spend \$2,000,000 in the next two years on buildings that are needed now. Professor Bradford, the University architect, sees the necessity of spending many, many times this sum within the next few years. But won't radio change all this?

A feasible scheme can easily be imagined where students receive class-room instructions in their own homes, only the professor needing to hustle to the radio station. Here the daily lecture would be sent out, as well as the assignment, to be prepared by the student. Written work would be mailed in to the University where the professor could grade the papers. Recitations would be held by the whole class operating on the same wave-length. Once a semester, the student would come to the University and take final examinations. The saving in buildings would be tremendous.

The objection that a University has to carry on research, which means the constructing of laboratories, can be met by having each worker engaged in a laboratory of his own. At present chemical workshops exist which are sent anywhere by express for from \$10 to \$25. Similarly, physics laboratories and botany materials could be worked up in outfits and sent to the student's home. In case a perplexing problem arose, the young experimenter need but tune in with his professor and converse as readily as if standing face to face.

While radio possibilities are too new to say absolutely what their exact form will be, one result is certain. An original and distinct line of excuses will be offered by students for not doing their work, such as "my audion blew just as you were giving the assignment," or "static was so strong I could not get you."



Model 601 Thorophone with Victrola Attachment.
Price.....\$20.40

THOROPHONE

(THUNDERPHONE)
TRADE MARK REG. U.S. PAT. OFFICE

GREAT RADIO VOICE

The Thorophone Real Loud Speaker. Beautiful Tone and Great Volume. Ornamental Concert Horn. Scientifically constructed with Controlled Mica Diaphragm.

The Thorophone requires better than the average radio receiving set to give a great, big, powerful volume, but just give it the power and its musical qualities will astonish you.

**Manufactured by
WINKLER-REICHMANN COMPANY
4801 S. Morgan St. Chicago, Ill.**

Oldest manufacturers of loud-speaking telephones in America. Only successful makers of large paging systems. Our loud speakers are used for paging in the great hospitals, hotels, clubs, railway stations, baseball parks and for giving general orders in the U. S. Navy.



Model 501 Thorophone Complete with Concert Horn.
Price.....\$35.00

Mail Orders attended to promptly. Send money order, check or draft for purchase price. Thorophone will be sent by express or insured parcel post; charges collect. Production of Radio type just coming through. These are not yet in the hands of dealers. Mail orders will be filled first and in the order of receipt. If shipment can't be made within one week, best delivery date will be advised and your money returned if desired. If you wish to return the Thorophone for any reason whatsoever, do so within ten days and your money will be immediately refunded.

Dealers, write for proposition—one outfit only sent to dealers on trial, money-back basis.

RADIO POSITIONS OPEN!

THERE is at present a great demand on this school for men trained in Radio. Manufacturers of Radio equipment are constantly asking for men for various positions at high salaries. We are also placing men on ship and land stations. Thus far the demand for men has exceeded the supply.

We can train you in a short time to qualify for one of these positions

Complete course covering Arc, Spark and Vacuum Tubes systems.

Y. M. C. A. RADIO SCHOOL
158 East 86th St., New York City



RADIO WEBBING FOR HEADPIECES

A special webbing woven Tubular for the metal insert. Furnished by the yard or pieces cut and tipped both ends. Call on our nearest branch.

THE RUSSELL MFG. CO.
Middletown, Conn.

Branch Offices:
NEW YORK CITY:
349 Broadway
DETROIT, MICH.:
523 Jefferson Ave. East
CHICAGO, ILL.:
1458 Michigan Ave.
ATLANTA, GA.:
60 South Forsyth St.

Soldered Connections

(Continued from page 266)

splice do not get the solder into the last turn indicated by the arrow, as this is liable to make the wire break below the splice. Solder both types with as little solder as possible.

It is sometimes desired to solder leads directly to the screws of binding posts and switch points, instead of securing them

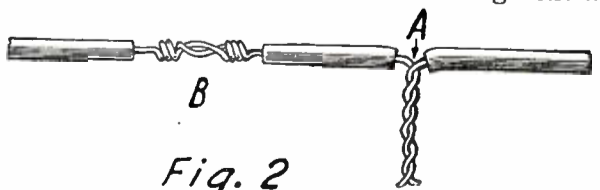
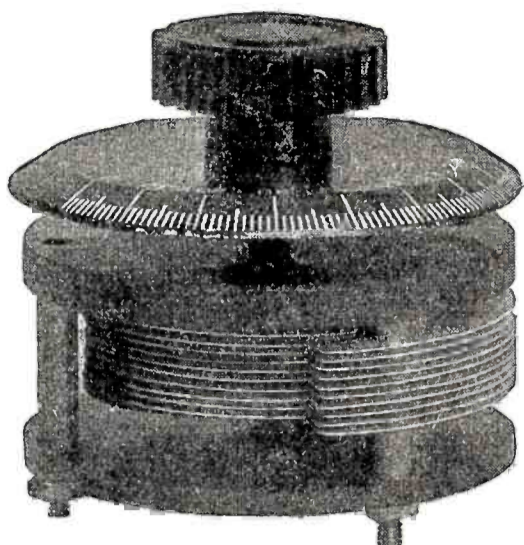

Fig. 2

Two Types of Splices, the Western Union and the Pigtail.

Announcement



100-C Condenser

“North” Variable Condensers
 “North” Variocouplers
 “North” Variometers

VARIABLE CONDENSERS

No. 100-C—.001 mfd \$4.50
 No. 35-C—.00035 mfd 4.25

VARIOCOUPLERS

No. 1A—250-700 meters 5.00

VARIOMETERS

No. 2B—180° Type 5.00

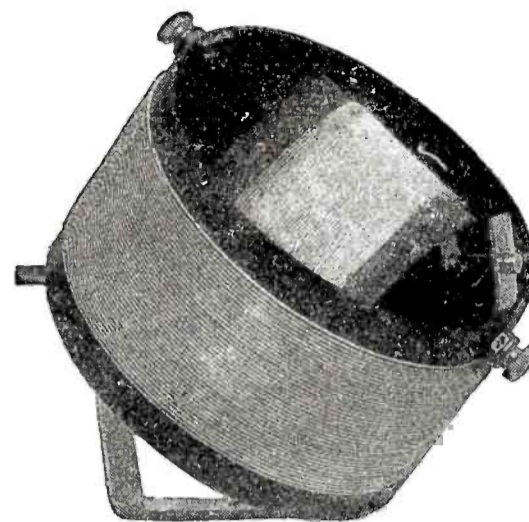

1A Variocoupler

North Variable Condensers are the most compact on the market. Plates are completely insulated from each other, eliminating all possible chance of shorting. Bakelite frame—outside dimensions, 1½" x 2 7/8".

North Variocouplers and Variometers are of the 180° type. Stator and Rotor made of Bakelite and wound with double cotton covered magnet wire. Nickel-plated brackets. These couplers and variometers provide sensitive tuning on short wave length.

Condensers, Variocouplers and Variometers can be used on 1/8, 3/16 or 1/4 inch panel.

The quality of North radio apparatus is fully up to North standards, established during twenty years of manufacture of high-grade telephone equipment.

The North Electric Manufacturing Company
 GALION, OHIO

Condenser
 No. 3

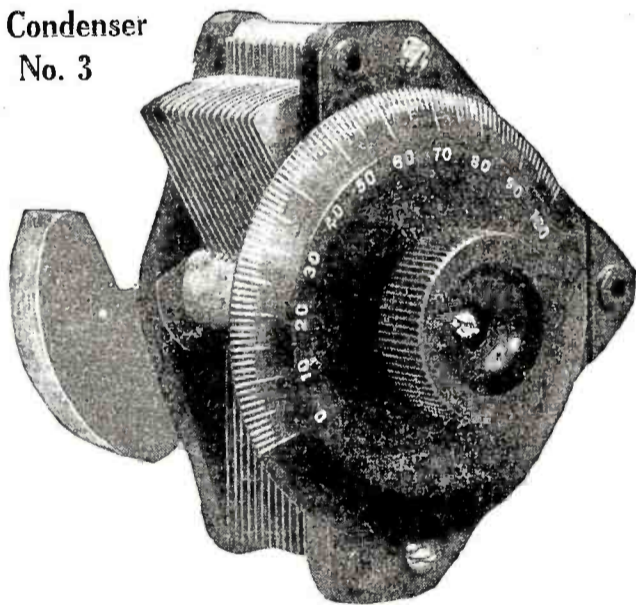

The Chelsea Amplifying Transformer is a supreme attainment in the design of Audio Frequency Transformers. It embodies the highest grade of materials obtainable and proper design, which reflects the result attained, namely, high amplification factor. It is unequalled either in electrical characteristics or good appearance.

CHELSEA

Variable Condensers
 (Die-Cast Type)

No. 1.—0011 m. f. mounted \$5.00
 No. 2.—0006 m. f. mounted 4.50
 No. 3.—0011 m. f. unmounted 4.75
 No. 3.—0011 m. f. unmounted, without dial 4.35
 No. 4.—0006 m. f. unmounted 4.25
 No. 4.—0006 m. f. unmounted, without dial 3.85

Top, bottom and knob are genuine bakelite. shaft of steel running in bronze bearings, adjustable tension on movable plates, large bakelite dial reading in hundredths, high capacity, amply separated and accurately spaced plates.

Unmounted types will fit any panel and are equipped with counterweight.

Purchase from your dealer; if he does not carry it, send to us.

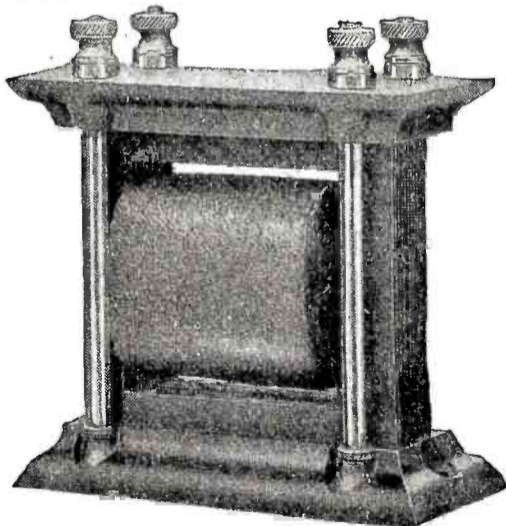

No. 50. PRICE, AS SHOWN, \$4.50



“Chelsea Bakelite Socket No. 60”

This socket has a bakelite base supporting four external, readily accessible binding posts. The tube receptacle is highly polished nickel and will take any standard detector and amplifier tube as well as the smaller size power tubes. It is primarily designed for receiving circuits, and may be mounted on either table or panel. Positive contact springs.

An added beauty to any radio station.

Price, as shown, \$1.00

Purchase from your dealer

CHELSEA RADIO CO., 150 Fifth Street, Chelsea, Mass.

Manufacturers of Radio Apparatus and Moulders of Bakelite

The 'READ-EASY'

AT LAST CHARGOMETER SCIENTIFICALLY ACCURATE

NO TAPPING
NO ROLL
OVAL FLOAT IN PLAIN VIEW
HEAVY GLASS DOUBLE LIFE

NO COAXING
NO DROP
NO DRAG

PRICE \$1.25 IN U.S.A.

FLOAT GUARANTEED NOT TO STICK

Sold on a strict Guarantee Adopted by Leading Battery Manufacturers

BATTERY READINGS MUST BE ACCURATE

DON'T RUIN YOUR BATTERY BY USING INACCURATE

BATTERY TESTERS

THE READ-EASY INSURES ACCURACY
Frequent inspection is your only insurance against heavy repair bills, loss of time and untold inconvenience. But a test tells you nothing unless your readings are absolutely accurate. Know the truth about your battery. Read-Easy will tell. Order yours today.

*No Spilling or Splashing of Acid
A Protection for Your Clothing and Rugs*

DEALERS AND JOBBERS—Our proposition means quick turn-over and volume sales. Our attractive counter display moves our goods off the dealers' shelves. We can give immediate delivery now in quantity lots.

Read-Easy is a quality, precision product. Handle the best hydrometer and you'll sell the most.

ALA MANUFACTURING CO.

Radio Dept. No. 12
401 to 419 S. Sangamon Street Chicago, Ill.

RADIO OWNERS—If your dealer can't supply you send \$1.25 direct to us and we will send at once parcel post prepaid insured.

PATENT APPLIED FOR

Dealers and Jobbers

IMMEDIATE DELIVERIES CAN BE MADE ON THE ALAMO SOCKET

Specifications
Insulated Feet; Nickel Plated Barrel; Barrel Reamed to size insuring no vibration of vacuum tube; Large Phosphor Bronze Springs; Base Satin Finished Formica Properly Labeled.

List Price \$1.00

— BRACKETS —

We are in a position to supply Nickel Plated Brackets for Panel Mounting of these Sockets singly or in groups of two or three in tandem.

UNUSUALLY ATTRACTIVE DISCOUNTS. WRITE OR WIRE FOR PROPOSITION.

The Alamo Sales Corp.

National Distributors
134 E. Market Street Indianapolis, Ind.

Our Radio Department is conducted by electrical engineers, which assure you dependable and highly efficient Radio equipment, either in complete sets or separate units, such as Head Receivers, Variocouplers, Variometers, Cabinets, Detectors, Antennas, Rotary Spark Gaps, Sliders, Panels, Dials, Knobs, Condensers, Grid Leaks, Contacts, Galena Crystals, etc. We especially recommend our popular Receiving Set, RESODON, which is one of the most desirable outfits for the home, club, etc. This set comes in a beautiful mahogany finished cabinet. Write for literature.

PAUL G. NIEHOFF & CO., Inc.
Electrical Laboratories and Manufacturers
238 E. Ohio Street, Chicago, Illinois

IMMEDIATE DELIVERY

ACCURATE FILAMENT CONTROL SINGLE KNOB ADJUSTMENT

Pat. Pend'g.
No. 223 \$1.85
PRECISE VERNIER RHEOSTAT
Dealers' Proposition

PRECISE MANUFACTURING CORPORATION
254 MILL STREET, ROCHESTER, N. Y.

under the nuts. In this case skin the wire to allow one turn of insulation around the screw and two turns of bare wire. Wind around, as shown in Fig. 3, and solder the last turn.

Jacks and other apparatus are provided with lugs having holes in the tips. Other apparatus have lugs with notches on the sides. With either type skin the wire to a

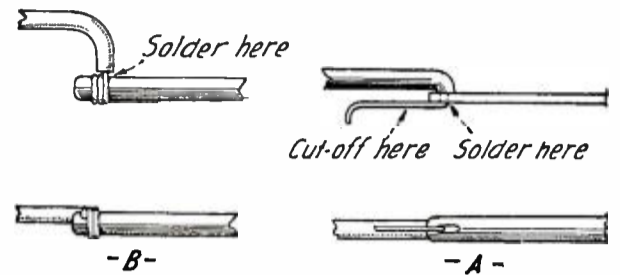

Fig. 4

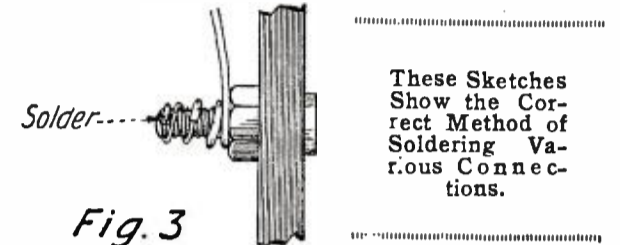

Fig. 3

point which gives the proper amount of slack. Twist the insulation tight with a little shellac on the ends of the fingers. If the lug has a hole in it, pass the wire through from the bottom or left side until the insulation is snug against the lug, then bend the end of the wire down against the lug, solder on the top or right side and cut off the extra length of wire. (See A, Fig. 4.) If the lug has the notch, bring the insulation up to the lug on the left or under side and wind the wire around the lug twice in the notch and break off the end by bending it back and forth under tension. Solder on the top or right side. (See B, Fig. 4.)

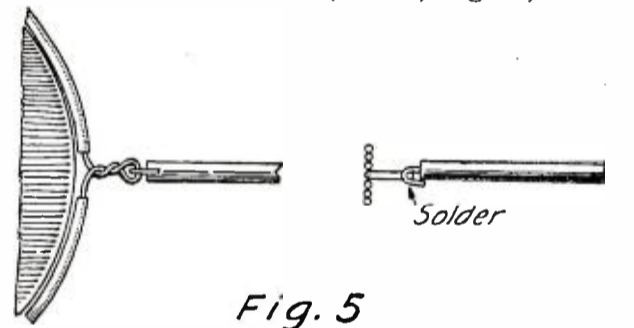

Fig. 5

This is the Best Way to Solder a Wire to the Taps of an Inductance Coil.

Tuning coils are sometimes tapped by making a loop in the winding at the proper place and skinning the wire in the loop. The best way to attach a wire to these loops is to skin the end of the wire for 1/8", make a small loop in the bare end and hook it through the loop with the free end up. Apply a touch of solder to the top. This method avoids the chance of breaking the loop that exists if it is attempted to twist the top wire around the loop. (See Fig. 5.)

These examples cover the most difficult problems in soldering which confront the radio constructor and most other cases will be found to approximate the ones given.

The amateur will find a pair of long-nose pliers, a buttonhook with the hook bent up at right angles to the shank (for smoothing out wires after soldering) and a bottle of thin shellac very useful accessories.

A.C. Rectification for C.W.

(Continued from page 234)

Rectifier jars are being built in the following manner: A small pint mason jar is first obtained. A wood cover is selected and boiled in paraffine. One strip of lead and one strip of aluminum measuring 3" in length by 1/2" in width is secured to the wood top piece. This is shown in Fig. 5. The metal

Get a Handy Binder for your RADIO NEWS. Holds and preserves twelve issues, each of which can be inserted or removed at will. Price 65c. Experimenter Pub. Co., Inc., Book Dept., 53 Park Place, New York.

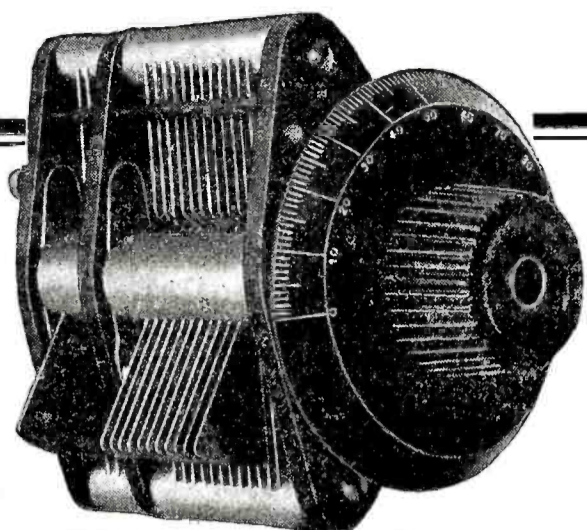

VERNIER "Eclipse" VARIABLE CONDENSERS (DIE CAST TYPE)

A laboratory quality instrument at commercial prices. Large production and fast shipments. Pure, hard Aluminum Stator and Rotor plates, accurately spaced and permanently held in exact position by the die cast process, assures maximum capacity. 23 plate and 3 plate **VERNIER** mounted 43 plate and 3 plate **VERNIER** mounted (Special bulletin and prices on request.)

NIAGARA

SUPER QUALITY

RADIO PRODUCTS

"NIAGARA" Radio Products backed by our large manufacturing facilities enable us to assure our **JOBBERS, DEALERS** and **MANUFACTURERS** of fast deliveries of "Super-Quality" merchandise. Let us have your inquiries.

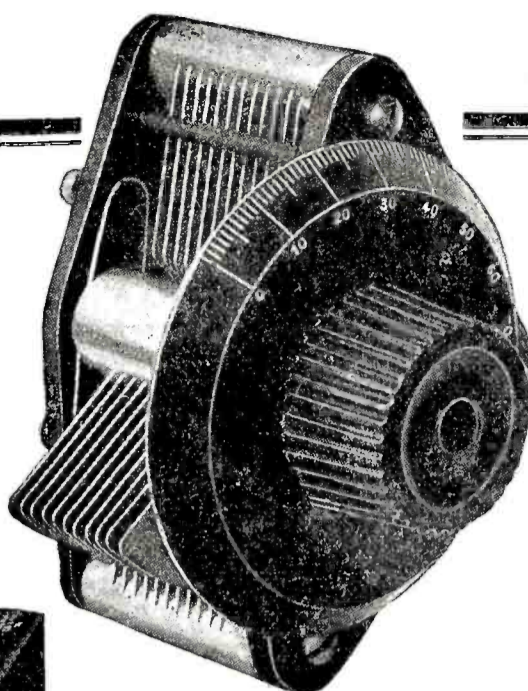

NIAGARA "Eclipse" VARIABLE CONDENSERS (DIE CAST TYPE)

Our "ECLIPSE" Type Variable Condensers are all equipped with Genuine moulded **BAKELITE** tops and bottoms, with threaded brass inserts. Perfectly balanced and beautifully finished. Immediate shipment. 23 Plate and 43 Plate sizes. (ask for special bulletin)

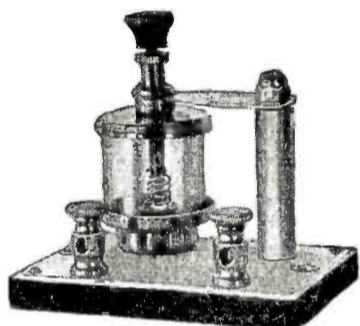

NIAGARA CRYSTAL DETECTOR
Mounted on **WHITE** Bakelite base. Dust proof—glass enclosed—accurate spring adjustment that will stay put. The most beautiful and efficient detector manufactured. Complete, with tested Galena. List.....\$2.25



NIAGARA Batteries have for many years been recognized as "world standard for quality." Our "B" batteries are truly "variable," as 15 binding posts are provided for instant voltage selection. Maximum economy is offered, due to our "refillable" feature, permitting replacement of exhausted or short circuited cell or cells without the use of solder. Handsome in appearance—absolutely noiseless. Long life guaranteed. The "fastest selling," most efficient "B" battery manufactured. (ask for complete illustrated special price list)

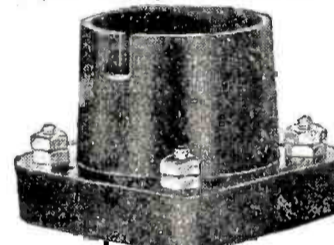

NIAGARA MOULDED V. T. SOCKET
Genuine moulded (one piece) Bakelite. Highly polished. Heat proof. Phosphor bronze contacts—nickel plated nuts and screws. Fast shipments. List price, each.....\$1.00

NIAGARA SALES CORPORATION 5 Waverly Pl., New York City

PARAGON

TRADE MARK REGISTERED

the PIONEER

- 1915 First regenerative receiver ever manufactured bore the name PARAGON.
- 1916 First Trans-continental Amateur Reception (California from New York; not pre-arranged) effected with a PARAGON Type RA-6 Receiver.
- 1916 First Trans-continental Amateur Transmission (New York to California; not pre-arranged) effected by PARAGON designed transmitter.
- 1917-1918 PARAGON acknowledged supreme on Western Front.
- 1921 First Trans-Atlantic Amateur reception effected with PARAGON receiving equipment, at which time 27 different amateurs scattered thruout the Eastern section of the United States registered signals at Ardrossen, Scotland—3500 miles.

THERE'S A REASON!

The **ADAMS-MORGAN CO.**

Manufacturers

UPPER MONTCLAIR, N. J., U. S. A.

Beldentube
TRADE MARK



Patent applied for.

A flexible insulating tubing of exceptional merit.

Combines the advantages of varnished cambric tubing with an attractive exterior finish.

Write for samples and prices. You will find them interesting.

Belden Manufacturing Company
2300 S. Western Ave., Chicago

Magnet Wire Dept.,
4625 W. Van Buren St.
Chicago

Eastern Office
and Warehouse,
Metuchen, N. J.

Moulded-RADIO-Accessories
Manufactured of Approved Material

Specifications Solicited

Knobs	Dials	Rotors
Couplers	Panels	Stators

International Insulating Corporation

Radio Dept. 25 West 45th St. New York City	Factory Springfield, Mass.
--	----------------------------------

BAKELITE
RADIO PARTS

Moulded To Your Design

Northern Industrial Chemical Co.
11 Elkins St. Boston, Mass.

Moulders of Electrical Insulation

EVERYTHING
IN
RADIO
HARDWARE

FRANK WHEELER and SON
MERIDEN, CONN.

Proposed Revision of Rule 86 of the National Electrical Code on Radio Equipment*

WITH DISCUSSION AND EXPLANATION PREPARED BY THE RADIO LABORATORY OF THE BUREAU OF STANDARDS

THE following report of the Technical Subcommittee on Radio Equipment (National Electric Code Rule 86) has been approved by the Standing Committee on Signal Systems, Wireless and Lightning, and in co-operation with Mr. Dana Pierce, Chairman of the Electrical Committee, is promulgated in order to produce field experience to substantiate the wisdom of the proposed rules before final submission to the Electrical Committee for incorporation into the 1923 edition of the National Electrical Code. Neither the Standing Committee nor the Electrical Committee has authority to suspend or replace the present Rule 86 of the National Electrical Code but this report is issued by the authority granted to the Chairman of the Standing Committee and the Chairman of the Electrical Committee for the information of inspection departments having jurisdiction over the application of the Code.

Suggestions for improvements in these proposed rules should be sent to William S. Boyd, Chairman, 175 W. Jackson Boulevard, Chicago, not later than September 1, 1922.

The following requirements are submitted as proposed revisions of Rule 86 National Electrical Code:

86 RADIO EQUIPMENT

Note: These rules do not apply to Radio Equipment installed on shipboard.

IN SETTING UP RADIO EQUIPMENT ALL WIRING PERTAINING THERETO MUST CONFORM TO THE GENERAL REQUIREMENTS OF THIS CODE FOR THE CLASS OF WORK INSTALLED AND THE FOLLOWING ADDITIONAL SPECIFICATIONS:

FOR RECEIVING STATIONS ONLY
ANTENNA

(a) Antennae outside of buildings shall not cross over or under electric light or power wires of any circuit of more than six hundred (600) volts or railway trolley or feeder wires, nor shall it be so located that a failure of either antenna or of the above mentioned electric light or power wires can result in a contact between the antenna and such electric light or power wires.

Antennae shall be constructed and installed in a strong and durable manner and shall be so located as to prevent accidental contact with light and power wires by sagging or swinging.

Splices and joints in the antenna span, unless made with approved clamps or splicing devices, shall be soldered.

Antennae installed inside of buildings are not covered by the above specifications.

LEAD-IN WIRES

(b) Lead-in wires shall be of copper, approved copper-clad steel or other approved metal, which will not corrode excessively and in no case shall they be smaller than No. 14 B. & S. gage except that approved copper-clad steel not less than No. 17 B. & S. gage may be used.

Lead-in wires on the outside of buildings shall not come nearer than four (4) inches to electric light and power wires unless separated therefrom by a continuous and firmly fixed non-conductor that will maintain permanent separation. The non-conductor shall be in addition to any insulation on the wire.

Lead-in wires shall enter building through a non-combustible, non-absorptive insulating bushing.

PROTECTIVE DEVICE

(c) Each lead-in wire shall be provided with an approved protective device properly connected and located (inside and outside the building) as near as practicable to the point where the wire enters the building. The protector shall not be placed in the immediate vicinity of easily ignitable stuff, or where exposed to inflammable gases or dust or flyings of combustible materials.

The protective device shall be an approved lightning arrester which will operate at a potential of five hundred (500) volts or less.

The use of an antenna grounding switch is desirable, but does not obviate the necessity for the approved protective device required in this section. The antenna grounding switch, if installed, shall, in its closed position, form a shunt around the protective device.

PROTECTIVE GROUND WIRE

(d) The ground wire may be bare or insulated and shall be of copper or approved copper-clad steel. If of copper, the ground wire shall be not smaller than No. 14 B. & S. gage and if of approved copper-clad steel it shall be not smaller than No. 17 B. & S. gage. The ground wire shall be run in as straight a line as possible to a good permanent ground. Preference shall be given to water piping. Gas piping shall not be used for grounding protective device. Other permissible grounds are grounded steel frames of buildings or other grounded metallic work in the building and artificial grounds such as driven pipes, plates, cones, etc.

The ground wire shall be protected against mechanical injury. An approved ground clamp

*Dept. of Commerce, U. S. Bureau of Standards, Washington, D. C.



COUPLER \$4.50
1/4" SHAFT

VARIOMETER \$5.00
1/4" SHAFT

IMMEDIATE DELIVERY

GET THESE POINTS:

Bearings will not bind. All metal parts white nicked. Rotor balls solid mahogany. Windings of green double cotton covered wire.

VARIOMETER

Binding posts have large knurled thumbnut. Minimum clearance between rotor and stator. Mounts easily and is designed for low dielectric losses and maximum range of induction. Black rubberized finish will not chip or peel off. Effective tuning range of 150 to 650 meters.

COUPLER

Primary windings on black formica tube. Has six taps for varied induction. Easily installed. Will operate perfectly and give highest efficiency. Save money by using this cheaper and better equipment.

LOOK AT THESE BARGAINS

Hard Rubber Variocouplers. Primary wound on hard rubber tubing. Secondary wound on hard rubber ball. Green cotton covered wire... **\$4.50 Each**

Hard Rubber Variometers. Green cotton covered wire, all parts white nicked, rotor ball and stator forms all hard rubber. A beautiful product that will give results. Each, \$5.00.

11-plate Variable Condenser, assembled without dial	\$3.25	1-piece Moulded VT Socket, each	\$.75
23-plate Variable Condenser, assembled without dial	3.50	Bridging Condensers	.60
43-plate Variable Condenser, assembled without dial	4.50	Galena Detector Crystals moulded in lead cups, each	.20
Audio Frequency Amplifying Transformers, ratio 3 1/2 to 1	4.00	Small Knob Indicating Switch, each	.50
Audio Frequency Amplifying Transformers, ratio 9 to 1	4.50	Large Knob Indicating Switch, each	.50
Rheostats, Moulded Base	1.00	Contact points with nuts, each	.01 1/2
Vernier Rheostats	1.50	Contact stops with nuts	.01 1/2
Potentiometers	1.50	Binding Posts, Moulded Knob, each	.10
1-piece Moulded Dials, 3/16 or 1/4 inch hole, each	.75	Regenerative Tuner, Detector and 2-step Amplifier, complete in one cabinet, engraved Bakelite Panel, without tubes or phones	\$120.00
Grid Condensers	.60	Regenerative Tuner, Detector and 3-step Amplifier	200.00
		Regenerative Tuner, Detector and 4-step Amplifier	275.00

Shipped immediately from stock—order now.

We pay transportation charges. If you are not satisfied in every respect with our equipment return at once and we will refund your purchase price.

DEALERS: write for our proposition.

RADIO INSTRUMENT AND PANEL CO.

26 N. DESPLAINES ST., CHICAGO, ILL.

Edelman's "Raytainor"



"Entertain with the Raytainor" and enjoy the music without any bother

Complete Loud Speaking Receiving Set—1923 Models Now Ready. The Raytainor comes to you ready for use. The experience is in the apparatus. Central Station efficiency combined with phonograph simplicity.

Order your machine now

Neatly assembled in phonograph type cabinet, this efficient radio receiving set comes with only two adjustments. Its use requires no outside aerial.

Harmonizing with home surroundings, the Edelman Raytainor comes complete with all wood tone chamber, free from bother and noises common to old style sets. There is no delicate regeneration. No skill is required. The outfit you hoped to get! Here it is, and at a reasonable price. Just the machine for summer resorts!

No permission of landlord required with this machine. Full instructions accompany every instrument. Absolutely safe from lightning danger. Any bright child can install and operate the Edelman Raytainor. Clear as a bell, without distortion, the Raytainor gives you full, loud volume with faithful repro-

duction of the original radio program. Sizes and styles to fit all purses. Immediate deliveries from reliable dealers in your locality, or they will order a machine for you for prompt delivery. Mail orders accepted if your dealer refuses to order genuine Edelman apparatus for you. Send his name.

All kinds of concerts can be received at your summer place.

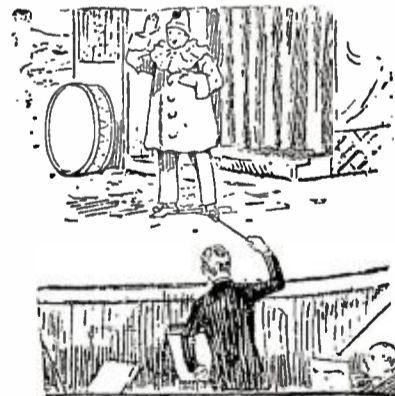

Console Model
Mahogany or Walnut



SPECIFICATIONS—Standard model Raytainor, genuine mahogany finish like top illustration, three vacuum tube type, automatic adjustments; only... **\$185.00**
Solid mahogany, four vacuum tube type, for use with famous Edelman Radio Concentrator requiring no outside wires (minimum range up to thirty miles); only... **\$225.00**
Genuine mahogany, four vacuum tubes, console model like lower illustration; only... **\$375.00**
Special machines up to eight vacuum tubes in cabinets to match your furniture, any range desired—price on application.

RAYTAINOR OUTFITS for restaurants, etc. We now supply the RAYTAINOR equipped with Western Electric Power Speaker for loud results in large assembly rooms. No expensive musicians to pay—Radio programs bring trade. Price, complete, including battery, vacuum tubes and everything necessary... **\$475.00**
Special RAYTAINOR, JR., 3 vacuum tubes, birch cabinet, mahogany finish... **\$147.50**

Philip E. Edelman, E. E., Mfg., Established 1910
No. 9 Church Street, New York, N. Y. Phone: Cortlandt 4708

BASCO CRYSTAL DETECTOR \$12⁰⁰

IMMEDIATE SHIPMENT LIST

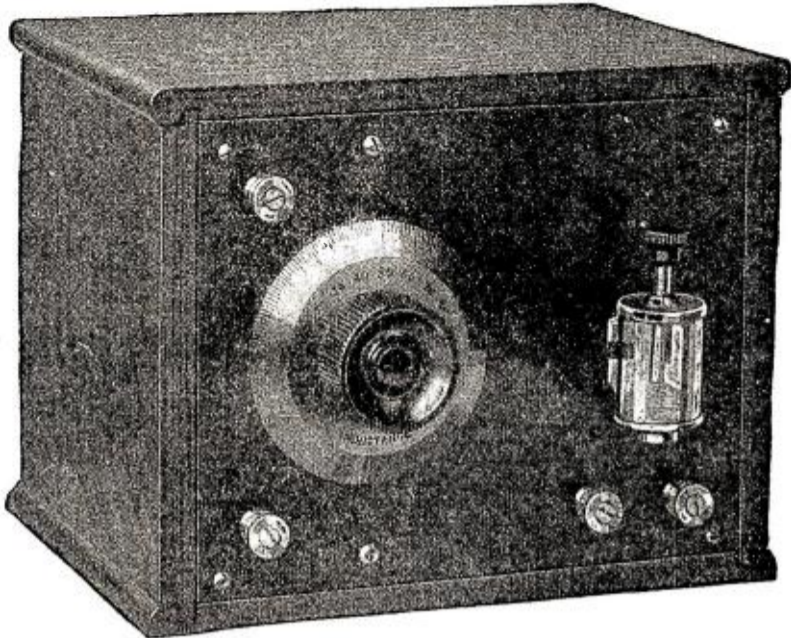

PHONES

2000 OHM

\$6.00 List

3000 OHM

\$7.50 List

DISTRIBUTORS AND DEALERS! We have a proposition that will net you big returns. Get in touch with us today.

BRIGGS & STRATTON CO.
MILWAUKEE, WIS.



TEL
BACK BAY
5 9 6 4

899 BOYLSTON ST.
BOSTON, MASS.

RADIO today is commanding the interest of more people than any other industry! Splendid opportunities are NOW available for those who are alive enough to see the possibilities. My fifteen years' experience in Radio tells you that FORTUNES will be made within the next five years for those who train themselves now and take advantage of the present opportunities.

The EASTERN RADIO INSTITUTE is the OLDEST, LARGEST and BEST EQUIPPED Radio school in New England. THOUSANDS of satisfied graduates tell our story best! Day and Evening classes. Start any Monday.

REMEMBER:—Our ORGANIZATION with YEARS of PHENOMENAL EXPERIENCE and SUCCESS is behind EVERY man who enrolls!

"Ask any man in Radio—he will tell you!"

Our illustrated prospectus for the asking.

F. D. PITTS, Director.

RADIO SUPPLIES AT A BIG SAVING

Standard Goods

	List Price	Our Price
Radiotron UV 201 Amplifying Tube.....	\$6.50	\$5.85
Western Electric Phones, 2200 Ohms per Pr.....	15.00	13.50
Murdock Phones No. 56, 3000 Ohms per Pr.....	6.00	5.40
Federal Phones, 2200 Ohms per Pr.....	8.00	7.00
Acme A-2, Amplifying Transformers, Semi-Mounted	5.00	4.50
Paragon Amplifying Transformers, mounted.....	5.00	4.50
Federal Plugs	1.75	1.50
Eveready B Battery, 766.....	3.00	2.50
Radiotron UV 202 Transmitting Tube.....	8.00	7.00
Brach Vacuum Gaps for lightning protection.....	2.50	2.25
Brach Vacuum Gap (outside type).....	3.00	2.80
Paragon V.T. Socket.....	1.00	.85
Paragon Rheostat	1.50	1.35

Through our long established connections and mail order methods, we are able to sell you standard radio supplies at less than prices at the ordinary radio store. Satisfaction absolutely guaranteed.

Buy from an Experienced Radio Expert

Mr. Gregory's ten years' practical experience and knowledge in the radio field assure you the best quality products. Let him help you with your problems. No obligation.

LISTEN FOR 2 KL
500 Watt C. W.

All orders shipped the day of receipt. Add 10c to the price of each item for postage. If you are not entirely satisfied with anything you order, return it and your money will be promptly refunded without question. Order from Gregory and save money. Send it in TODAY!

A. V. GREGORY, 42 Broad Street, Red Bank, N. J.

shall be used wherever the ground wire is connected to pipes or piping.

WIRES INSIDE BUILDINGS

(e) Wires inside buildings shall be securely fastened in a workmanlike manner and shall not come nearer than two (2) inches to any electric light or power wire unless separated therefrom by some continuous and firmly fixed non-conductor making a permanent separation. This non-conductor shall be in addition to any regular insulation on the wire. Porcelain tubing or approved flexible tubing may be used for encasing wires to comply with this rule.

RECEIVING EQUIPMENT GROUND WIRE

(f) The ground conductor may be bare or insulated and shall be of copper, approved copper-clad steel or other approved metal which will not corrode excessively under existing conditions and in no case shall the ground wire be less than No. 14 B. & S. gage except that approved copper-clad steel not less than No. 17 B. & S. gage may be used.

The ground wire may be run inside or outside of building. When receiving equipment ground wire is run in full compliance with rules for protective ground wire, in Section d, it may be used as the ground conductor for the protective device.

FOR TRANSMITTING STATIONS ANTENNA

(g) Antennae outside of buildings shall not cross over or under electric light or power wires of any circuit of more than six hundred (600) volts or railway trolley, or feeder wires nor shall it be so located that a failure of either the antennae or of the above mentioned electric light or power wires can result in a contact between the antennae and such electric light or power wires.

Antennae shall be constructed and installed in a strong and durable manner and shall be so located as to prevent accidental contact with light and power wires by sagging or swinging.

Splices and joints in the antenna span shall, unless made with approved clamps or splicing devices, be soldered.

LEAD-IN WIRES

(h) Lead-in wires shall be of copper, approved copper-clad steel or other metal, which will not corrode excessively and in no case shall they be smaller than No. 14. B. & S. gage.

Antenna and counterpoise conductors and wires leading therefrom to ground switch, where attached to buildings, must be firmly mounted five (5) inches clear of the surface of the building, on non-absorbent insulating supports such as treated wood pins or brackets equipped with insulators having not less than five (5) inch creepage and air gap distance to inflammable or conducting material. Where desired, approved suspension type insulators may be used.

(i) In passing the antenna or counterpoise lead-in into the building, a tube or bushing of non-absorbent insulating material shall be used and shall be installed so as to have a creepage and air-gap distance of at least five (5) inches to any extraneous body. If porcelain or other fragile material is used, it shall be installed so as to be protected from mechanical injury. A drilled window pane may be used in place of bushing, provided five (5) inch creepage and air-gap distance is maintained.

PROTECTIVE GROUNDING SWITCH

(j) A double-throw knife switch having a break distance of four (4) inches and a blade not less than one-eighth (1/8) inch by one-half (1/2) inch shall be used to join the antenna and counterpoise lead-ins to the ground conductor. The switch may be located inside or outside the building. The base of the switch shall be of non-absorbent insulating material. Slate base switches are not recommended. This switch must be so mounted that its current-carrying parts will be at least five (5) inches clear of the building wall or other conductors and located preferably in the most direct line between the lead-in conductors and the point where ground connection is made. The conductor from grounding switch to ground connection must be securely supported.

PROTECTIVE GROUND WIRE

(k) Antenna and counterpoise conductors must be effectively and permanently grounded at all times when station is not in actual operation (unattended) by a conductor at least as large as the lead-in, and in no case shall it be smaller than No. 14 B. & S. gage copper or approved copper-clad steel. This ground wire need not be insulated or mounted on insulating supports. The ground wire shall be run in as straight a line as possible to a good permanent ground. Preference shall be given to water piping. Gas piping shall not be used for the ground connection. Other permissible grounds are the grounded steel frames of buildings and other grounded metal work in buildings and artificial grounding devices such as driven pipes, plates, cones, etc. The ground wire shall be protected against mechanical injury. An approved ground clamp shall be used wherever the ground wire is connected to pipes or piping.

OPERATING GROUND WIRE

(l) The radio operating ground conductor shall be of copper strip not less than three-eighths (3/8) inch wide by one-sixty-fourth (1/64) inch thick, or of copper or approved copper-clad steel having a periphery, or girth (around the outside) of at least three-quarters (3/4) inch (for example a No. 2 B. & S. gage wire), and shall be firmly secured in place throughout its length. The radio operating ground conductor shall be protected and supported similar to the lead-in conductors.

150 BLUE PRINTED RADIO DESIGNS

OVER 100,000 SATISFIED CUSTOMERS IN 18 MONTHS

Enabling you to build your own Radio Phone Receiver or Transmitter at a 50 to 75% saving under finished instrument prices.

FEATURING

- Designs backed by actual performance
- Expert Senior Commercial Engineering
- Expert Draftsmanship
- Each Blue Print 21 by 28 inches, one to four sheets per subject

INFALLIBLE DRAWING SYSTEM SHOWING

- Assembly Views
- Detailed Parts
- Technical Data
- Wiring Diagrams
- Complete Bill of Material
- Knowledge Blue Print Reading Unnecessary

Ask for Catalog 77

CONTAINS

- Illustrations of Models built by customers
- Actual Results as related by customers
- Complete List of Blue Prints Designs
- Price Lists of Parts for each Design

Models will be on display in our New York office.
Prints at Leading Dealers.

EXPERIMENTERS INFORMATION SERVICE, Suite 2300, 220 W. 42d St., N.Y.C.

MID-WEST DISTRIBUTOR

COMMONWEALTH EDISON COMPANY, 74 West Adams St., Chicago, Illinois

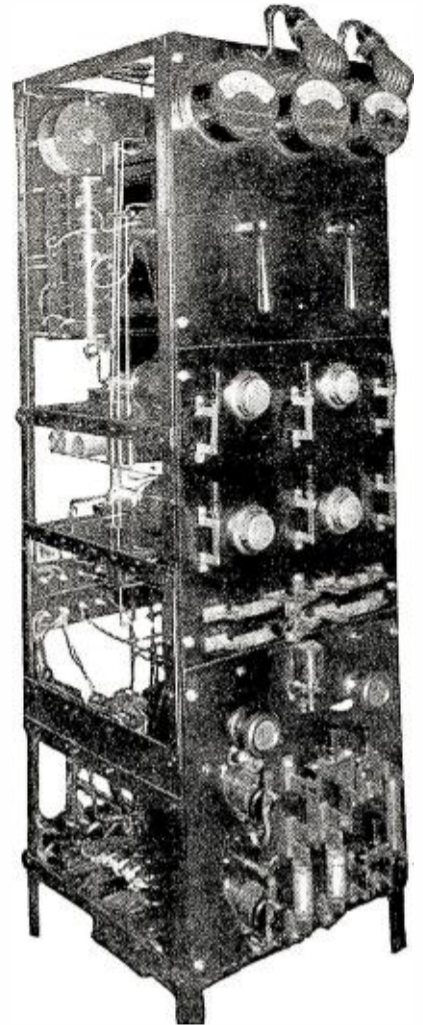

HIGH POWER RADIOPHONE AND CW TRANSMITTER BUILT FROM E. I. S. BLUE PRINTS

Send for our Handsome New Catalog Number 20

REGAL RADIO PRODUCTS

Attractive Proposition for Dealers and Distributors



"REGAL" Receiving Set

Will tune from 150 to 1800 meter wave length. All parts made by ourselves. A handsome precision instrument with our reputation back of it. Mahogany finished cabinet\$40.00

"REGAL" Variable Condenser

43" plate \$4.50 23 plate \$3.50
11 plate 3.00 Vernier 2.50

"REGAL" Lightning Switch\$3.00

"REGAL" Inductance Switch.....\$2.00

"REGAL" Telephone Connectors\$1.50

If your dealer does not carry "REGAL" RADIO PRODUCTS write us direct

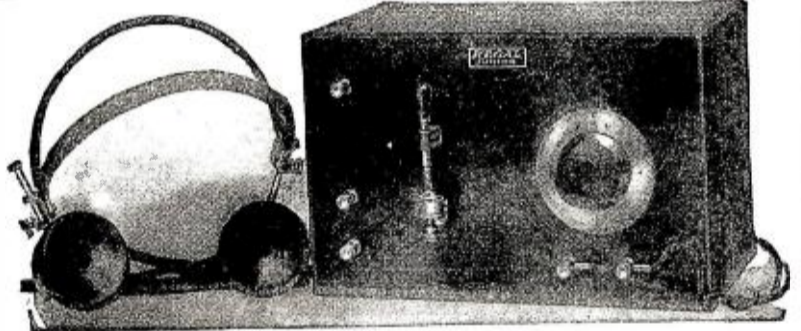

"REGAL" Jr. Crystal Receiving Set

Handsomely constructed with all parts of our own manufacture. Will tune from 25 to 40 miles. Price complete with set "Federal" Double Phones...\$20.00

"REGAL" RHEOSTAT

Mechanically perfect. Exposed resistance wire with positive contact. Six (6) Ohms resistance, 2.2 amperes.

A big seller, price \$1.25

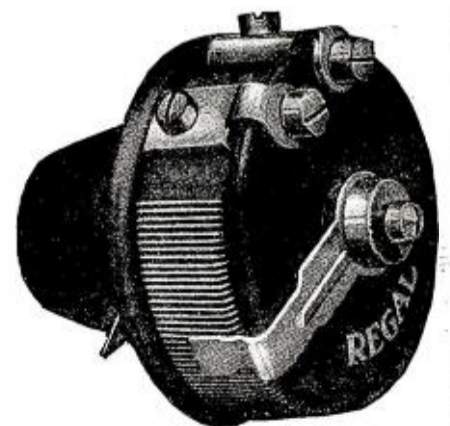

THE AMERICAN SPECIALTY MFG. COMPANY General Offices, 145-165 Holland Ave. BRIDGEPORT, CONN.
Factories, Holland Ave. and Ash St.

"WESTRAD"
RADIO APPARATUS

Jobbers and Dealers: Write for our proposition
IMMEDIATE DELIVERIES ON
VARIOMETERS AND VARIO-COUPLERS

"WESTRAD" BAKELITE DIALS

Molded from genuine Bakelite. Positively will not warp nor discolor. Non-brittle with highly polished surface. Division scale recessed and filled with white enamel. 100 divisions read from right



to left for clockwise rotation. Made with the usual exacting care of all Westrad Apparatus. Absolutely true running. Specify 3/16" or 1/4" shaft when ordering. No. 500, price, each..... \$1.00

"WESTRAD" RHEOSTAT

Specially designed for filament control of vacuum tubes operating on 4 to 6 volts. Resistance unit mounted on a disc 2 1/4" in diameter. Non-corrosive exposed wire allows free cooling. Furnished complete, with Bakelite white arrow knob, shaft and supporting screw. Must be seen to be appreciated. Price, each..... \$1.10



"WESTRAD" LOOSE COUPLER

Polished Mahogany finish. Range of 200 to 2,500 meters. All metal parts are brass, nicked and highly buffed. Secondary inductance has 10-point switch, mounted on Bakelite coil head. Wound with green silk covered wire. No. 800, price each..... \$9.00



"WESTRAD" INSULATORS

Highly efficient. Midget No. 405. Diam. 1 5/16"; length, 3 1/4" over-all. Weight, 1/4 lb. Price, each..... \$0.25
Type No. 410 (shown above) diam. 1 1/2"; length, 7 1/4"; weight, 1/2 lb. Price, each..... \$0.60
Strain Type No. 415. Diam., 1 1/2"; length, 10 1/8" over-all. Weight, 1 1/4 lbs. Price..... \$1.00



WESTERN RADIO MFG. CO. INC.
154B Whiting St., CHICAGO, ILL.
H. E. WILLMORE, Vice-Pres. and Gen. Mgr.

OPERATING GROUND

(m) The operating ground conductor shall be connected to a good permanent ground. Preference shall be given to water piping. Gas piping shall not be used for ground connections. Other permissible grounds are grounded steel frames of buildings or other grounded metal work in the building and artificial grounding devices such as driven pipes, plates, cones, etc.

POWER FROM STREET MAINS

(n) When the current supply is obtained directly from street mains, the circuit shall be installed in approved metal conduit, armored cable or metal raceways.

If lead covered wire is used, it shall be protected throughout its length in approved metal conduit or metal raceways.

PROTECTION FROM SURGES, ETC.

(o) In order to protect the supply system from high-potential surges and kick-backs, there must be installed in the supply line as near as possible to each radio-transformer, rotary spark gap, motor in generator sets and other auxiliary apparatus one of the following:

1. Two condensers (each of not less than one-half (1/2) microfarad capacity and capable of withstanding six hundred (600) volt test) in series across the line and mid-point between condensers grounded; across (in parallel with) each of these condensers shall be connected a shunting fixed spark gap capable of not more than one-thirty-second (1/32) inch separation.
 2. Two vacuum tube type protectors in series across the line with the mid-point grounded.
 3. Non-inductively wound resistors connected across the line with mid-point grounded.
 4. Electrolytic lightning arresters such as the aluminum cell type.
- In no case shall the ground wire of surge and kick-back protective devices be run in parallel with the operating ground wire when within a distance of thirty (30) feet.
- The ground wire of the surge and kick-back protective devices shall not be connected to the operating ground or ground wire.

SUITABLE DEVICES

(p) Transformers, voltage reducers, keys, and other devices employed shall be of types suitable for radio operation.

DISCUSSION AND EXPLANATION OF THE ABOVE PROPOSED REVISION OF RULE 86 ON RADIO EQUIPMENT

These rules do not apply to radio equipment installed on shipboard, but have been prepared with reference to land stations.

RECEIVING EQUIPMENT

(a) *Antenna*—Indoor receiving antennæ are not included within the requirements of this proposed rule, which provides for the protection of radio equipment against lightning. Indoor receiving antennæ and auxiliary apparatus are, however, included in the general requirements covering the wiring of signal systems, for it is obviously desirable to insure, for example, the freedom of all receiving apparatus from contact with electrical power circuits either inside or outside of buildings.

It is desirable that electrical construction companies install radio antennæ and apparatus for persons who are not familiar with electric wiring. This will tend to insure the installation of antennæ and apparatus in a strong and durable manner. It is important that antenna wire be used in such size and tensile strength as to avoid its coming in contact with any electric power wires whatsoever.

The size and material of which the antenna is made should depend, to some extent, upon the length of the span which the antenna must bridge. It is suggested that for the ordinary receiving antenna about 100 feet long No. 14 B. & S. gage soft drawn copper wire can safely be used. If other materials are used, the size which is chosen should be such as to insure tensile strength at least equal to that of the No. 14 soft copper wire suggested above.

The requirements covering splices and joints in the antenna span are for the purpose of avoiding accidental falling of such wires upon light or power wires, of less than 600 volts where it is found necessary to cross such lines. The rules, it will be noted, permit crossings with lines of 600 volts or less, if they do not happen to be trolley wires or feeders to trolley wires. In such a case, it is desirable to use wire of a larger size than No. 14 B. & S. gage in order to minimize the chance of accidental contact of the antenna with the power wires.

The interchangeable use of copper and of approved copper-clad conductor is suggested on account of the fact that these two kinds of wire are practically equivalent in their conductivity for high-frequency current.

(b) *Lead-in Wires*—No mention is made of the insulation from the building of the receiving antenna or lead-in wire except that this lead-in wire should be run through a bushing. The latter provision is chiefly to protect the wiring against the possibility of short-circuiting with electric power lines which may run in the wall and whose location may be unknown to the persons installing the radio equipment. This requirement serves also to protect the antenna lead-in wire against contact with metal lath or other metal parts of the building.

From a signaling standpoint, it is desirable to use insulators for receiving antennæ in order

**Protect Your Home and Receiving Set
Just as Your Telephone Line Is Protected—**

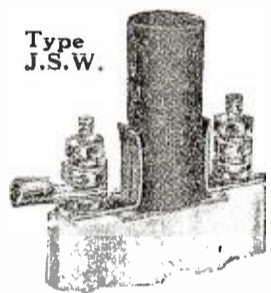

Type J.S.W.
\$2.00 From All Good Dealers

FROM THE INSIDE—USE A

**JACOBUS VACUUM
AERIAL PROTECTOR**

Permits Inside Use
National Underwriters have ruled that automatic safety features of the JACOBUS permit inside installation—the way the protector on your telephone line is installed.

No Ground Switch
Carries off all static and lightning automatically without damage to itself or interference with your set. Protection every minute of the day and night. Underwriters approve the JACOBUS to replace ground switch. Use a JACOBUS, the best form of lightning protection.

APEX ELECTRICAL SPECIALTY CO., Inc.
77 ORANGE STREET, NEWARK, N. J.

Emerson Said:—

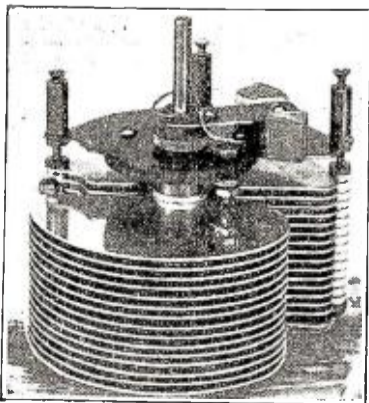

Shipping Weight 2 lbs.

*"Let a man preach a better sermon, write a better book,
or build a better mouse trap than his neighbor and the
world will make a beaten path to his door."*

**The Haynes
Precision Variable Condenser**

is selling itself on its own merits. It no longer needs
our recommendation.

Capacity	Price	Complete with counter balance and pig-tailed connections.
.001..... mfd.	\$5.75	
.0005..... mfd.	4.75	
.00025..... mfd.	3.90	

HAYNES RADIO CO., Inc.
629 LEXINGTON AVENUE NEW YORK CITY

Equip Your Wireless With *ARKAY* RADIO PRODUCTS

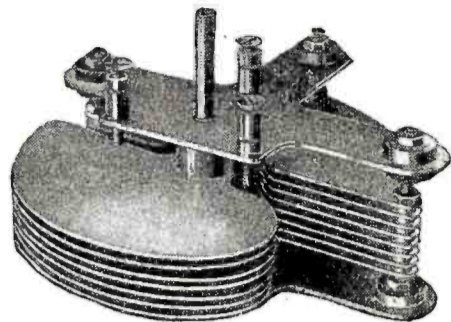

ARKAY VARIABLE CONDENSERS

Arkay Variable Condensers increase the sensitivity of your tuning set; afford a delicate adjustment on low capacities and insure positive operation throughout the range; made with hard aluminum plates. Cannot warp.

15 Plate—.0005 Mfd. Capacity.....\$3.75
29 Plate—.001 Mfd. Capacity.....\$4.75

Unmounted—No Dial or Knob

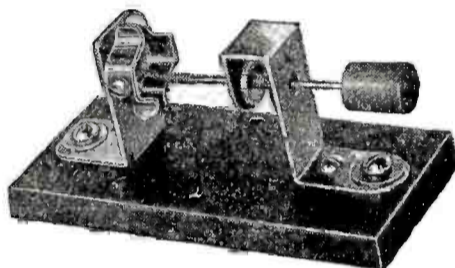

ARKAY CRYSTAL DETECTORS

A detector with universal adjustment, permitting the whole face of the crystal to be searched for sensitive spots. Cannot be jarred out of adjustment. Takes either mounted or unmounted crystals.

Price, 75c

Highest Standard of quality obtainable. Finest workmanship. Every accessory scientifically correct in every detail.

Arkay Loud-Speaker Radio Horn . . . \$5

The Arkay Horn fits any make of receiver, works on one or two stages of amplification, amplifies your signals, speech or broadcasted concerts without the slightest distortion. You get wonderful results through the Arkay. Black enamel, \$5. Polished nickel, \$6.

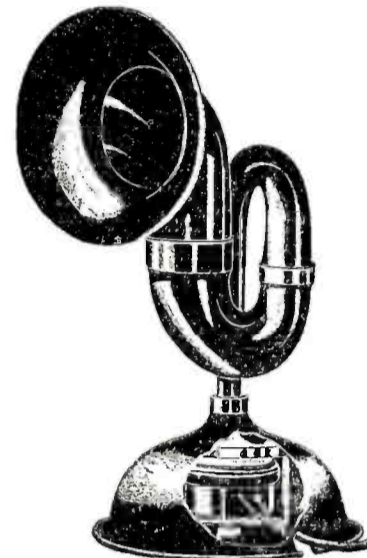

DISTRIBUTORS

CANTON, OHIO Wireless Mfg. Co.	NEWARK, N. J. Radio Distributing Co. Wholesale Radio Equipment Co.	PITTSBURGH, PA. Robbins Electric Co.
DETROIT, MICH. Grier Battery Supply Co.	NEW YORK, N. Y. Manhattan Electric Supply Co.	Ludwig Hommel & Co.
INDIANAPOLIS, IND. Hatfield Electric Co.	PHILADELPHIA, PA. Ship Owners Radio Service, Inc.	Radio Electric Co.
MILWAUKEE, WIS. Kesselman-O'Driscoll Co.	PHILADELPHIA, PA. Philadelphia W'less Sales Corp.	TOLEDO, OHIO Marshall-Gerken Co.

Dealers Write for Proposition

Manufactured and Distributed by
Riley-Klotz Mfg. Co., Inc.

17-19 Mulberry Street, Newark, N. J.

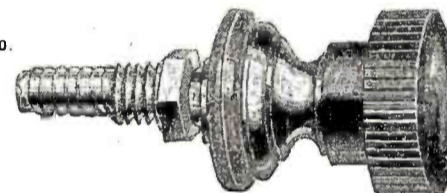

ARKAY VERNIER ADJUSTER

You can tune closer and sharper if you will attach this adjuster to your dials. Spring keeps the adjuster pressure constant.

Price, \$1

DUCK'S NEW CATALOG No. 16

275 Pages A Catalog Deluxe

"RFH" RECEIVER

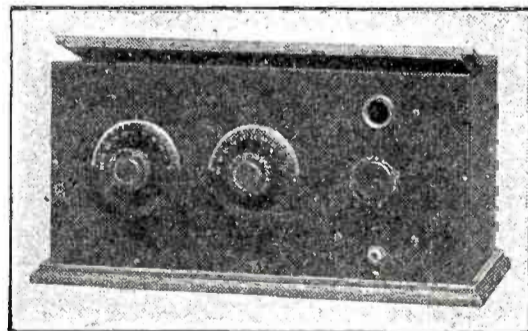

Our RFH receiver is ideal for the reception of radio music and speech. Big features are simple tuning, no howling of the bulb, no body capacity effects, and none of the minutely painstaking adjustments that are necessary with so many receiving sets on the market. Duck's super-selective variometer and special variable condenser comprise the tuning apparatus. Designed for use with plug and jack. Duck's positive contact socket and new filament rheostat are standard with this set. The range is approximately 150 miles. With the addition of our No. A214-B two-step amplifier, mounted in a mahogany cabinet, a range up to 500 miles is obtained. One-quarter inch panel is of 3/4" formica. Set is complete ready for use with the exception of head set, bulb, "A" battery, "B" battery and antenna material.

Type RFH Receiver with Detector.....\$35.00

Over fifty pages of the latest hook-ups (wiring diagrams), and invaluable and up-to-date data and information on radio, including important instructions for building antenna.

Send 25c in coin carefully wrapped for your copy of this wonderful book, the most unusual and complete catalog ever put between the pages of two covers. Not sent otherwise. It is not only a catalog, but a wonderful text book on radio. Enormous cost and tremendous demand prevents further distribution at a less retainer.

Never in the history of radio has there been such a catalog. The radio data and diagrams embracing upwards of fifty pages gives the experimenter more valuable and up-to-date information than will be found in many textbooks selling for \$2.00, and \$1.00 could be spent for a dozen different radio catalogs before you could gather together the comprehensive listing of worth while radio goods found in this great catalog.

A brief summary of the radio goods listed in this catalog:
The entire radio catalog of the Radio Corporation, with a wealth of scientific and technical data on C.W. transmitting sets, and all the diagrams for assembling of these sets; the complete Remler catalog, which embraces 25 pages, the Westinghouse, Firth, Murdock, Federal, DeForest, Clapp-Eastham, Brandes, Connecticut Company, Thordarson, Turney, Magnavox Company catalogs, the best products of Adams-Morgan, Signal and countless other manufacturers, including our own complete line of radio apparatus, and many individual items and parts used in radio work today.

DIALS

SOCKETS

RHEOSTATS

We are able to deliver sockets, dials and rheostats in most any quantity. Large capacity molds have been made, and production of these items mount to considerable figures daily. 3" knob and dial with either 3/16" or 1/4" shaft is \$1.00; No. A666 Bakelite mold and socket with highly polished metal receptacle molded into base and connections on proper base, \$1.00; No. A650 Filament Rheostat, \$1.00. This is one of the best rheostats in the market. Attractive discounts to dealers.

DEALERS

We want live responsible dealers in every city and town in the United States, both for the sale of our extensive line of radio apparatus and all other worth while lines of radio goods on all of which we can quote attractive dealers' discounts. We can offer you facilities and advantages that no other radio house can offer.

Send only 25c for copy of this wonderful catalog. You will need no other when you have Duck's and you cannot find in all others combined what you will find in Duck's Wonder Catalog.

THE WILLIAM B. DUCK CO., 231-233 Superior St., Toledo, Ohio

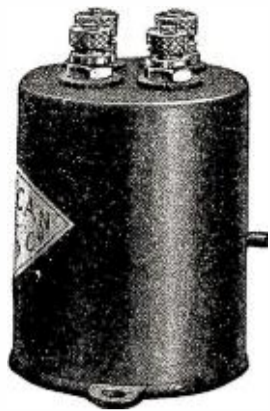

"ALL-AMERICAN"

Type R-10

Radio Frequency Amplifying Transformer

150-550 Meter **\$4.50**

For amateur and commercial receiving instruments. Sharp enough for the most discriminating and simple so the layman can easily tune. Efficient, effective and well made. Can be used with Radiotron, Cunningham, Moorehead, A. P. or Meyer tubes.

Attractive discounts to jobbers

SEND FOR ILLUSTRATED FOLDER

RAULAND MANUFACTURING CO.

SUCCESSORS TO ALL-AMERICAN ELECTRICAL MANUFACTURERS

35 So. Dearborn St.

CHICAGO, ILLINOIS

Also manufacturers of "All-American" Audio-Frequency Amplifying Transformers—50 Watt. Power Tube Sockets. Grid-condensers. Send for folder.

TRY REYNOLDS RADIO SERVICE

(OLD)
9ZAF

from DENVER

(NEW)
KLZ

Distributors for
Kennedy, Clapp-Eastham,
Grebe, Chelsea,
Remler, Frost,
Murdock, DeForest,
Magnavox, Elec. Specialty.

We are now located in our NEW STORE, with the largest stock of Radio Apparatus in the West.

Our facilities for serving you have been greatly increased.

When you think of RADIO think of "REYNOLDS RADIO"

REYNOLDS RADIO CO., Inc. 1534 Glenarm Pl. DENVER, COLO.

THE LARGEST DISTRIBUTORS OF RADIO APPARATUS IN THE WEST

TAKE NO CHANCES WITH LIGHTNING

Lightning does the unexpected—that's why you cannot take chances and be safe. There is one protector which you can absolutely depend upon, because the principle is right—that's the

S & C Radio Lightning Protector

Designed by Specialist in High Voltage Protection It is installed outdoors, directly in the lead (not below) and eliminates the necessity of a ground switch. Requires no attention, and is always on guard.

You can listen in on a stormy night with an S & C Protector. S & C fuses are depended upon for the protection of high voltage power equipment up to 150,000 volts.

PLAY SAFE—Ask your dealer to show you the S & C Radio Lightning Protector, or write for full descriptive circular at once. This is a matter of vital importance to you, and should be taken care of promptly.

SCHWEITZER & CONRAD, Inc.,

4437 Ravenswood Avenue

Chicago, Ill.

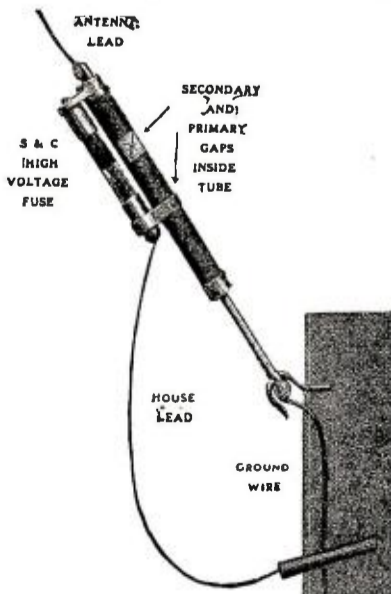

STRAIN TYPE...\$6.00
WALL TYPE...\$12.00

that wet weather may not cause the antenna to become partly short-circuited to the ground.

(c) *Protective Device*—The requirement for a protective device to be connected between the antenna and ground terminals of the receiving set is for the purpose of carrying lightning discharges or less violent discharges caused by induction or by atmospheric electricity to the ground with a minimum chance of damage to the receiving apparatus, building, or operator. A fuse is not required as a part of the protective device, though lightning arresters which are provided with fuses will not necessarily fail to receive approval. If a fused lightning arrester is used, it makes it less likely that the antenna terminal of a receiving set will be put at a high voltage in case the antenna falls upon an electric light or power wire. The absence of the fuse, on the other hand, makes it possible for the antenna, if it accidentally falls across the power wires, to become fused at the point of contact and thus fall to the ground and eliminate the hazard. The antenna terminal of the receiving set should be connected to the point of junction of the fuse with the arrester.

Lightning arresters may be used inside the building, and in such a case they will receive better protection from moisture and mechanical injury than lightning arresters placed on the outside of a building wall.

Protective devices of reliable manufacture are approved by the Underwriters' Laboratories, and can be depended upon to operate at the required voltage. The use of a cheaply constructed home-made arrester is not recommended, since it may easily get out of order and fail to operate at the low voltage which is desirable. Arresters should be enclosed in such a way as to protect the breakdown gap from dust. One disadvantage of the vacuum tube type of arrester is that it may cease to function without giving warning that it is inoperative. A list of the approved protective devices and ground clamps is contained in the "List of Inspected Electrical Appliances," published by the Underwriters' Laboratories. This list is revised semi-annually and may be consulted upon application to the principal office of the Underwriters' Laboratories, Inc., 207 East Ohio St., Chicago, Ill., and at offices and agencies throughout the United States and Canada.

While an arrester connected between the antenna and ground is regarded by many as sufficient protection, it is somewhat safer to install a switch in parallel with it as an added protection. Particularly if the arrester is inside of the building and the ground connection is made to a radiator, it is desirable to use in addition the outside ground connection.

If the antenna is properly connected to the ground, such connection prevents the antenna from becoming a hazard to the building and its contents and may act to supplement the protection given by lightning rods. The arrester should have the most direct connection to the ground which it is feasible to make, otherwise the antenna may become a hazard with respect to lightning.

(d) *Protective Ground Wire*—While it is desirable to run the protective ground wire in as direct a line to ground as possible, it is more important to provide a satisfactory contact at the ground itself than to avoid a few bands in the ground wire.

(f) *Receiving Equipment Ground Wire*—If the ground wire of a receiving set passes through a wall, it should be insulated for the same reasons as the antenna lead-in wire referred to in paragraph (a) above.

If the ground wire is exposed at all to mechanical injury it should be of larger size than the minimum permitted under the rules and certainly not smaller than No. 10 B. & S. gage. It should, for mechanical protection, be enclosed in wood moulding or other insulating material. Ground wires should not be run through iron pipe or conduit because of the choking effect at radio and lightning frequencies.

TRANSMITTING EQUIPMENT

(j) *Protective Ground Switch*—On account of the larger size of the ordinary transmitting antenna, it is more likely to be subject to damage from lightning; and on account of the high voltages produced by radio transmitting equipment, it is desirable to provide for the use of a double-throw switch for connecting the antenna either to the transmitting apparatus or to the ground. The use of this switch makes it possible to entirely disconnect the antenna from the transmitting apparatus when not in use.

The objection to slate-base switches is chiefly from the radio engineering viewpoint, on account of the absorption of water by many kinds of slate and the presence of conducting streaks.

Under this rule one has the choice of the standard 100-ampere 600-volt single-pole, double-throw switch or a special antenna switch using 60-ampere copper which has an air-gap distance of at least four inches.

(o) *Protection from Surges, etc.*—On account of the difficulty which has been experienced by the induction of voltages in the supply lines of a transmitting station, it is advisable to use a protective device across the terminals of each machine or transformer connected to this power line. It would also seem desirable to connect a similar protective device across the power line and near the point of its entrance to the building and on the house side of the meters.

It is desirable that research on the performance of protective devices and the means for avoiding surges and "kick-backs" in the power supply lines be promoted.

For further suggestions regarding good and bad practice in the installation and maintenance

MOST SENSITIVE!

Better Than a Regenerative Set

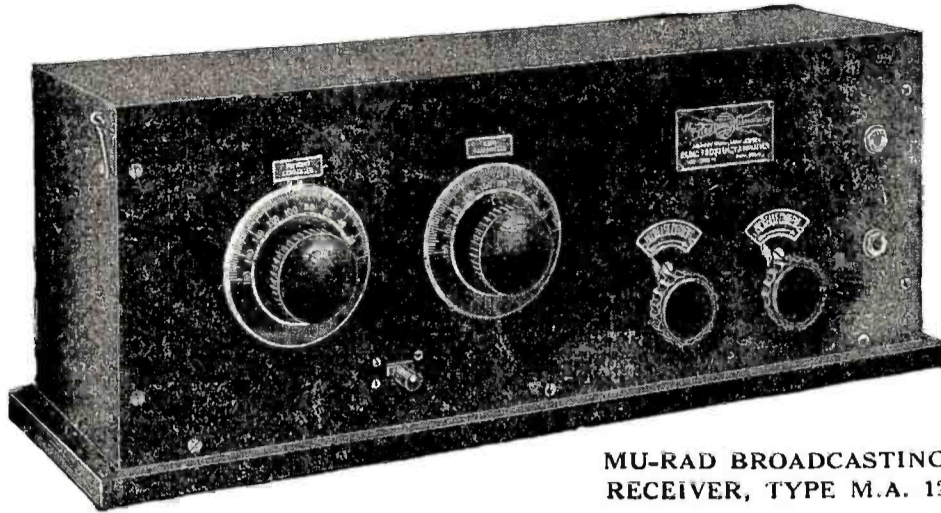

MU-RAD BROADCASTING RECEIVER, TYPE M.A. 12

Use With Indoor Loop Aerial

Reduce Static and Interference

THE VERY FINEST RADIO RECEIVING SET

A three stage radio frequency amplifier and detector set developed with the deliberate idea of producing a receiver of superior sensitiveness. Direct comparison with the best sets proves the astounding accomplishment of our engineers. Many times more sensitive than a regenerative tuner and far easier to operate. This set on a 1½ foot square indoor coil aerial will bring in the radio programs several times louder than a regenerative tuner and a 40 foot antenna. May be used with Radiotrons or A.P. Tubes. The most highly developed set on the market. Very reasonably priced.

BEST in Appearance and Performance

Enclosed in handsome, highly polished mahogany cabinet with Radion panel. All connections in the rear. Thoroughly tested and covered by an absolute money back guarantee of satisfaction. Write for Bulletin No. 13.

Dimensions:

19" Long \$142⁵⁰
6½" High
6" Deep

DEALERS Write for Proposition

The demand for this remarkable set will be tremendous everywhere. A simple demonstration of its extreme sensitiveness will bring all the orders you can handle. Get our proposition. Ask for Bulletin No. 13.

MU-RAD LABORATORIES, Inc.
800 Fifth Avenue - - Asbury Park, N. J.

GRIEF and PATIENCE

A lot of both have been caused by market conditions. The impatient customer must remember he is just one of thousands who are anxious to be served promptly. We thank the patient ones. We have done and will continue to do the best we can to be of service to all who buy from "MISSOURI."

VACUUM TUBES	
No. UV-200 Detector	\$ 5.00
No. UV-201 Amplifier	6.50
No. UV-202 5 watt transmitter	8.00
No. UV-203 50 watt transmitter	30.00
No. UV-204 250 watt transmitter	110.00
ATLANTIC-PACIFIC	
A. P. Detector	5.00
A. P. Amplifier	6.50
Send us your orders for Tubes. Our stock is complete.	
SOCKETS	
No. 550 Murdock	1.00
No. UP-552 Radio Corp.	1.50
No. UR-542 Radio Corp.	1.00
No. UT-541 Radio Corp.	2.50
No. 30 Paragon	1.00
CONDENSERS	
No. UC-1014	2.50
No. UC-1015	5.75
No. UC-1803	5.00
No. UC-1806	7.00
No. UC-1831	9.00
BRAIDED AEROPLANE ANTENNA WIRE	
Per 100 ft.	.50
No. 14 Bare copper wire, per 100 ft.	.50



REGENERATIVE RECEIVERS	
No. CR-4 Grebe 175-680 meters	\$65.00
No. CR-5 Grebe 175-3000 meters	80.00
No. CR-8 Grebe 175-1000 meters	80.00
No. CR-9 Grebe 175-3000 meters with det. and two stage amplifier, complete	130.00
No. RA Westinghouse 150-700 meters	68.00
No. RC Westinghouse 150-700 meters	132.50
Aeriola "Jr."	25.00
Aeriola "Sr."	75.00
LOUD SPEAKERS	
No. A-3 Magnavox, new type	45.00
VOCOLOUD, station type	30.00

TELEPHONES	
Type C Baldwins	\$12.00
Type E Baldwins	13.00
Type F Baldwins	14.00
No. 56 Murdock 2000 ohm	5.00
No. 56 Murdock 3000 ohm	6.00
No. 2500 Manhattan 2000 ohm	6.00
No. 2501 Manhattan 3000 ohm	7.00
RHEOSTATS	
No. 25 Paragon	1.50
No. 214 General Radio	2.50
No. 560 Murdock	1.00
No. 120-A FADA new type	1.00
No. 810 Remler 4 ohm	1.00
AMPLIFYING TRANSFORMER	
No. A-2 Acme semi-mounted	5.00
No. UV-712 Radio Corp.	7.00
No. 231 Gen. Radio	5.00
No. 231 Gen. Radio	5.00
POWER TRANSFORMERS	
No. JP-1368-325 watt	25.00
No. UP-1016-750 watt	38.50
No. UL-1008-Oscillation	11.00
"B" BATTERIES	
No. 763 Eveready 22½ volts	2.00
No. 766 Eveready 22½ volts tapped	3.00
No. 2156B.P. Burgess 22½ volts tapped	3.00
No. 2156 Burgess 22½ extra large	3.50

Please include sufficient postage with all C. O. D. orders

MISSOURI RADIO SUPPLY COMPANY
4623 Maryland Ave. SAINT LOUIS MISSOURI

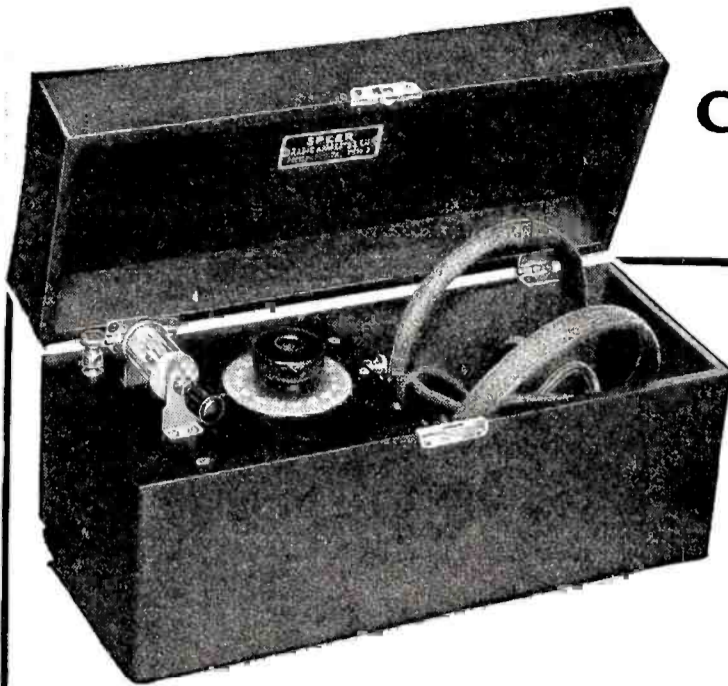

SPEER Crystal Receiver \$9.00 (WITHOUT PHONES)

An exceptionally efficient instrument designed for the reception of local Radio Concerts. Handsome cabinet — finest workmanship throughout.

SPEER CRYSTAL DETECTOR

GLASS ENCLOSED — SPRING ACTION — MOULDED BASE — NICKEL FINISH — WITH MOUNTED CRYSTAL

\$2.00

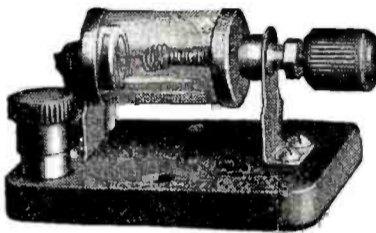

BRASS SLIDERS
3/16" and 1/4"



Buy SPEER products from your dealer. If he cannot supply you we will ship direct—prepaid—on receipt of price.

Jobbers and Dealers Write for Our Proposition

RADIO APPARATUS CO.
6600 Hamilton Ave., Pittsburgh, Pa.

Startling Price Reduction

Handsome hardwood Cabinets, satin mahogany finish, hinged lid, front rabbeted to take panel.

You Will Be Proud of Your Set in This Cabinet

Prices—Postpaid in U. S., Delivery guaranteed. Cash with order. Panels not included in price.

Panel size	Inside dimensions			Price
	High	Wide	Deep	
6x 7"	5 1/2"	6 1/2"	7"	\$1.50
6x10 1/2"	5 1/2"	10"	7"	1.70
6x14"	5 1/2"	13 1/2"	7"	1.95
7x18"	6 1/2"	17 1/2"	10"	2.20
9x14"	8 1/2"	13 1/2"	10"	2.70
12x14"	11 1/2"	13 1/2"	10"	2.95

The Southern Toy Company
HICKORY, N. C.

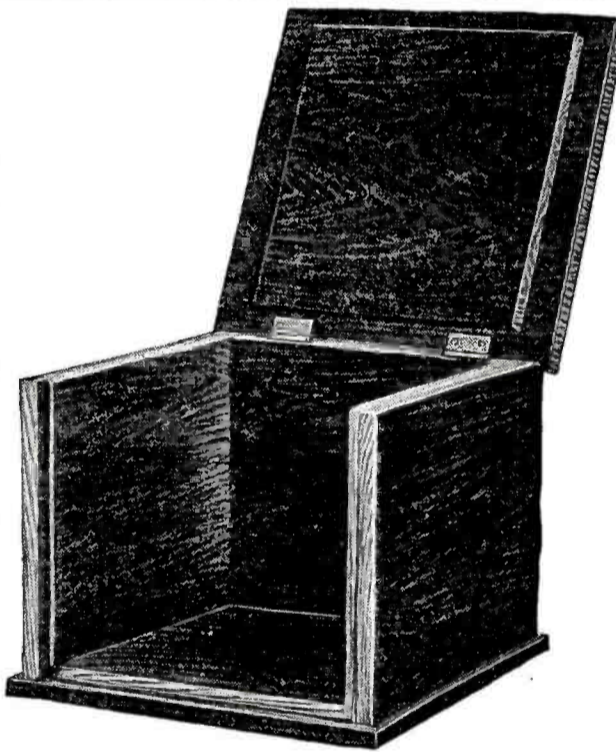

ARKAY UNIVERSAL CAM SWITCH

Gives Absolute Control
Of Any Amplifier

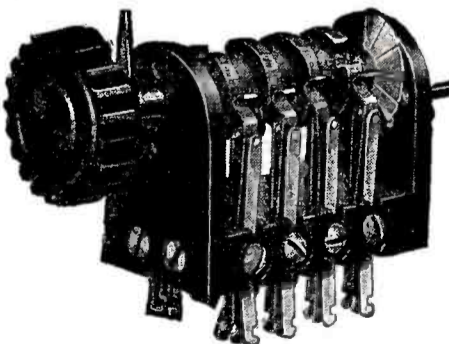

PRICE \$5

THE ARKAY SWITCH takes the place of jacks and plugs in amplifier circuits. Its rotary action gives instant change-over from detector to amplifier or succeeding changes of amplification, at the same time providing filament control.

THE ARKAY SWITCH can be used as a send-receive switch or a short and long wave change switch, in fact for any switching necessity, by merely shifting the position of the cams on the shaft.

There is no switch on the market superior to the ARKAY. It is built of highest grade condensite; contacts of sterling silver, set in nickel silver springs. Superior workmanship throughout—and backed by the Arkay guarantee.

Manufacturers, Jobbers and Dealers Will Be Given Liberal Discounts

RILEY-KLOTZ MANUFACTURING CO.

17 MULBERRY STREET - - - - - NEWARK, NEW JERSEY

of signal wires and equipment, reference should be made to "National Electrical Safety Code, 3d edition, October 31, 1920, Bureau of Standards Handbook No. 3" and especially Section 39. This is obtainable from the Superintendent of Documents, Government Printing Office, Washington, D. C.

The 1920 edition of the "National Electrical Code," which contains the regulations of the National Board of Fire Underwriters, including Rule 86, which is now the rule in effect covering radio signaling apparatus, may be referred to at any local inspection department of the fire underwriters, or may be purchased from the National Board of Fire Underwriters, 76 William St., New York City.

Storage "B" Battery

By C. C. BROWN

MUCH has been written about the storage "B" battery and others. It has been the writer's experience, in trying out several different types, that most of them caused considerable noise, due to non-depolarization. The details of these batteries will not be gone into. Results can be had with some of them, but not for any length of time. When the common type of "B" battery we are now familiar with is nearly discharged, upon examination it will be found to have eaten through the zinc. This renders the battery inoperative. Even if there is any juice in the cells, the battery will be noisy.

The small storage battery makes an economical "B" battery and if constructed properly it will be free from noises. The writer has used one of this type for several months. For just ordinary use with an amplifier, the battery will hold a charge for a month. Another good feature is, when nearly discharged, the battery can be placed on charge for a few minutes, and will be

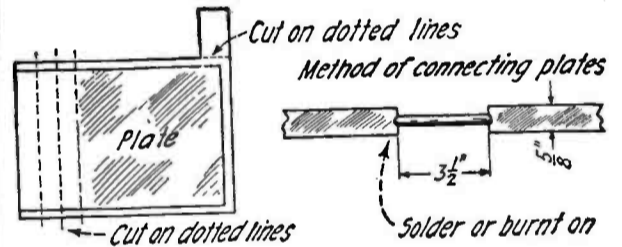

Method of Cutting and Assembling the Plates for the Storage "B" Battery.

ready for an evening's use. About 15 minutes usually suffices for this. The battery should be placed on charge immediately after being used when it is in this condition.

Various types of storage cells have been described in different radio magazines, and nearly all were made of lead, cut in strips, 10" long, and bent in a "U" shape. These were placed in glass containers and a solution of acid poured in each bottle or tube. The plates were then formed by charging and discharging. This requires considerable time. After the plates are formed, the capacity is not great enough to run several steps of amplification. A 100-volt battery of this type has a discharge rate of about 15 or 20 milliamperes for two days. While this type of battery is entirely satisfactory, it has not the desired capacity in many cases.

The battery that will now be described, has a steady discharge capacity of 250 milliamperes for three days, and is suitable for transmission if enough cells are provided. This battery at 500 volts will take care of four 5-watt tubes. The writer constructed a 100-volt unit, at first, and later four more 100-volt units were added.

The necessary material is as follows: 50 glass test tubes, 1"x6", 14 negative storage battery plates, eight battery separators, three quarts of 1250 electrolyte, one piece of sheet lead, 12"x4"x1/8", and wood to make the rack. This may be purchased for about \$4. Any one can duplicate this, with a little time and patience.

DETAILS

The plates are cut at the edge of each grid division, as in Fig. 1. These divisions are about 5/8" wide, and each plate has at least eight of them. The plates used by the

Federal HEAD TELEPHONES

Light In Weight
Extremely Sensitive—
Durably Constructed—
Carefully Matched In Tone—
Will Perfectly Reproduce
Radio Sounds—

Prices—Per Pair:
No. 53-W, Total Res. 2200 ohms,
\$8.00
No. 52-W, Total Res. 3200 ohms,
\$10.50

ABSOLUTELY THE BEST
ON THE MARKET
REGARDLESS OF PRICE



Made by a Company With 22
Years' Successful Experience in
the Manufacture of High Grade
Telephone Apparatus

The
FEDERAL COMPANY
With Its Rating of \$1,000,000.00
and Over Guarantees the Effi-
ciency of all Federal Apparatus

DEMAND
From Your Dealer GENUINE
FEDERAL APPARATUS
Accept No Substitute

Federal Telephone & Telegraph Co.

BUFFALO, NEW YORK

SHUR GRIP RADIO PLUG

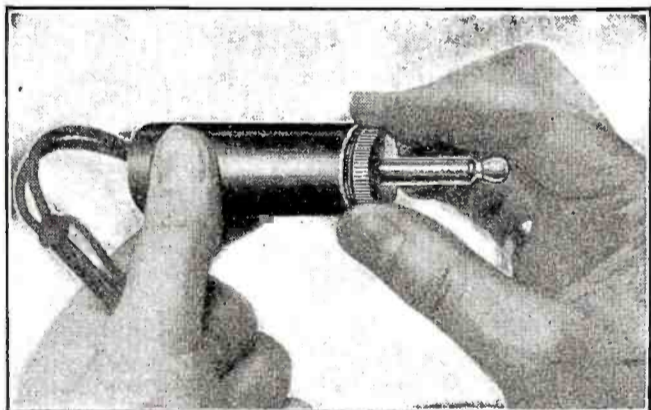

(Patent Applied For)

PLUG CONNECTED

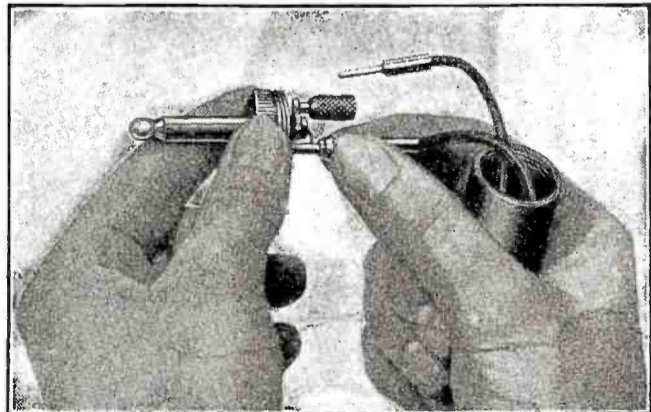

(Patent Applied For)

PLUG DISCONNECTED

The best for professionals and amateurs.
Positive contact in easiest, quickest way.
Fits any size of telephone tip.
A simple turn of the adjustable bushing with
finger and thumb connects wire to plug.
No tools needed to attach tips.
Unnecessary to cut telephone tips.
Fits any standard jack.

LEADING DISTRIBUTORS

- | | |
|--|--|
| Schimmel Electric Supply Co.
526 Arch St., Philadelphia, Pa. | The Elliott Electric Co.
813-815 Superior Ave.,
West Cleveland, Ohio |
| Domestic Electric Co., Inc.
908 Pine St., St. Louis, Mo. | J. H. Bunnell & Co.
32 Park Place, New York City. |
| The Nash-Odell Co.
172 N. Franklin St.,
Chicago, Ill. | Wetmore-Savage Co.
76-78 Pearl St., Boston, Mass. |
| Hatfield Electric Co.
Indianapolis, Indiana | Pettingell Andrews Co.
Boston, Mass. |
| Southern Electric Co.
5-7-9 So. Gay St., Baltimore, Md. | F. D. Pitts Co.
12 Park Square, Boston, Mass. |
| Commercial Electric Supply Co.
138 East Congress St.,
Detroit, Mich. | Atlantic Radio Co.
727 Boylston St., Boston, Mass. |
| | Doubleday-Hill Electric Co.
Pittsburgh, Pa. |



Price \$1.50



Manufactured by MARTIN-COPELAND CO., Providence, R. I.

"The Plug That Holds"

CONDENSERS

W	43 Plate with 3" dial.....	\$5.00	W
	23 Plate with 3" dial.....	4.00	
	11 Plate with 3" dial.....	3.50	
	3 Plate with 3" dial.....	3.00	

1½" Rotary Switch Lever with 14 contacts, 2 Binding posts, 2 stops... Boxed \$1.00

M

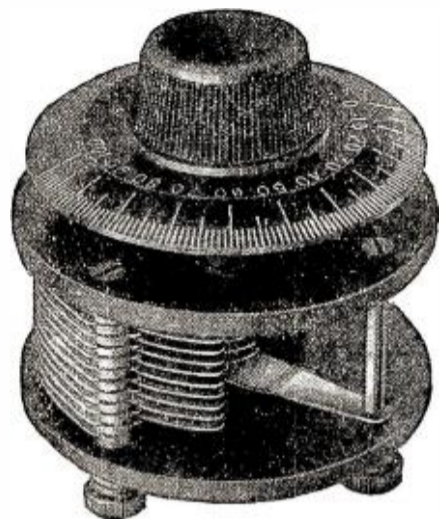

M

C

C

WESTFIELD MACHINE CO., Westfield, Mass.

For Dealers Only

As one of the largest exclusive radio jobbers in the entire country we are well equipped to supply radio equipment immediately. All orders are shipped out within 48 hours after their acceptance by us unless otherwise specified in writing.

Our stock consists of standard apparatus only and is complete in every way. We can furnish anything from a binding post to the most expensive receiving equipment. At the present time we are developing a new line of apparatus which we will manufacture ourselves. A preliminary bulletin on this as well as our jobbing line will be mailed on request.

In order to afford protection to present and future customers, we ask that prospective dealers furnish some information as to their legitimate status in the radio field upon writing for literature.

Manufacturers of "SUPERADIO" Products.

THE SUPERIOR RADIO AND TELEPHONE EQUIPMENT CO.

85 EAST LONG STREET

COLUMBUS, OHIO

GET THE BEST RESULTS FROM YOUR WIRELESS

USE

BRIGHT STAR "B" BATTERIES

NOISELESS LONG SERVICE
LONG SHELF LIFE

BRIGHT STAR BATTERY CO.

New York Chicago San Francisco
310 Hudson St.-9 So. Clinton-Furniture Ex. Bldg.

SCREWS

Standard, Contact, Binding Post, Switch Stop, and Other Specials



KEYSTONE SCREW CO.
YARDLEY, PENNA. U.S.A.

Brass or Steel Plain or Plated

Accuracy! Quality! Service!

Main Office and Plant: New York: Cleveland:
Yardley, Pa. 117 Leonard St. 1215 Edwards St.
Buffalo: Pittsburgh: Philadelphia:
R. C. Neal & Co. Machinists Supply Co. Bullitt Bldg.

writer, were secured from junked auto-starting batteries. The positive plates in such batteries are seldom of any value for this purpose. When a starting battery is junked, it is because the positive plates are worn out. In many cases, the negative plates are good. The plates should be dry before cutting with hack saw. About half of the plates can be clamped together, and all sawed at once. Care must be taken in cutting the plates to keep them straight. If they are not straight, it will result in some of the grid supports being cut away. The plate will then break, as it has nothing to hold it together. When all the plates are cut, they must be cleaned of all sulphate, and the top brightened for burning or soldering. Burning is the best method, but soldering will be O.K. if this is not possible. Next cut 49 strips of lead, ¼"x3½" and two 6" long for the end terminals. If burning is desired, it may be accomplished in this manner: Use a 6-volt auto-starting battery, the negative pole connected to the lead strip, the positive to a hard carbon. A piece of thin lead should be used to build up the joint. This should be done as quickly as possible, so the active material in the plates will not be overheated. Heavy wire should be used to connect the carbon, and other electrode.

The rack is made according to Fig. 3. It is self-explanatory: Fifty 1/8" holes are drilled through the top of rack and nearly

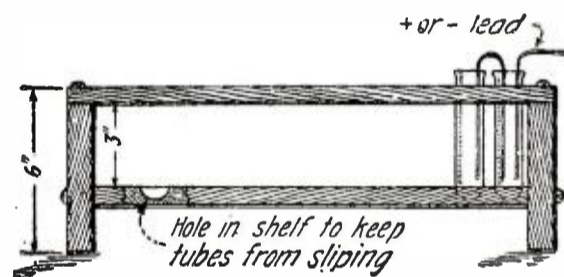
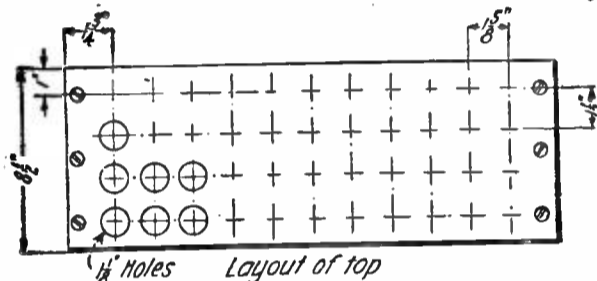

A Very Efficient "B" Battery May be Constructed With Old Plates From Storage Battery and Test Tubes. This Sketch Shows How the Cells May be Supported in a Rack.

through the bottom of it. The hole must be in the lower shelf of the rack to prevent the tubes from slipping. The tubes should not come in contact with each other, as this will cause leakage of current, and will result in noise; 7/8" lumber should be used, as there is considerable weight to the completed battery. Use screws instead of nails to hold the rack together.

Fig. 2 illustrates the method of connecting the plates. When the plates and rack have been finished, the tubes may be placed in the holes provided for them. The plates are then bent in a "U" shape, and inserted in the tubes, as in Fig. 4. The wood separators must then be split, and a piece wedged between the two plates in each cell. If this is not done, the plates may buckle, and come in contact with each other. The separators should run to the bottom of the tubes, and to within ¼" above the plates. The separators can be easily cut with a pair of tin snips. When all of this has been completed, the electrolyte may be put in the cells; fill to within ½" of the top. The battery is now ready for its initial charge. The positive is marked after the battery is connected to the charging source. About 112 volts should be used. If D. C. is not available, a chemical rectifier will have to be used. This has been described before, in several radio magazines. Two carbon lamps in series parallel, will be about the correct charging rate. It takes about 10 days to form the plates, then the positive will turn brown.

EASTERN CLASSIC RECEIVING SET

Model E. D. A-3

OUR New Cabinet type built of solid mahogany, having the appearance of a talking machine, standing 37 in. high, 14 in. deep, and 17 in. wide.

IT has two stages of amplification, wave lengths ranging from 150 to 1500 meters, with receiving capacity of approximately 500 miles, distance, of course, depending upon conditions.

Pamphlets and descriptive literature forwarded upon request. Price..... **\$125⁰⁰**

EASTERN RADIO MANUFACTURING CO.

122-124 Fifth Ave. (Near 17th St.) New York City

If it is desired, the builder may make the solution into a paste or jelly: the battery never has to be filled with water, if this is done. Silicate of soda is used for this purpose, and the right amount may be determined by experimenting. A small piece of separator should be placed at the top and bottom only, if paste is used. The paste should be forced all around the tube and a piece of separator about 1½" long forced in the bottom of the tube. More paste should then be forced in around the top, and a small piece placed between the plates, at the top. Paraffin wax should then be poured over the top of this. After the wax cools, a hot rod, about ⅛" in diameter, should be run down into the paste through the wax. This will provide a vent for the gasses generated while charging. This is most important. The plates should be moistened with distilled water before the jelly is forced into the tubes.

Five of these 100-volt units may be used on a 20-watt tube set, and radiation of nearly three amperes can be had with the batteries. No filter is needed. Anyone

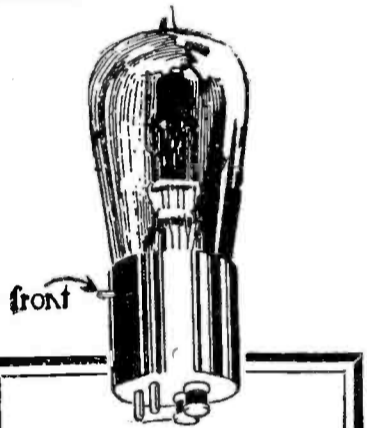

Absolute Protection

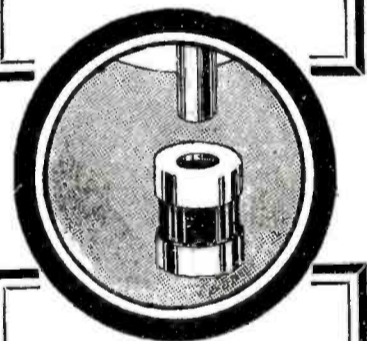

Carrying Capacity

½, ¾, 1, 1¼, 1½,
2, 2½, 3 amperes

Absolute Protection for Bulb Filaments

JUST now when vacuum tubes, besides being expensive are hard to get, you should insure continuous operation of your set with the

RADECO SAFETY FUSE

(PAT. PENDING)

for VACUUM TUBES, METERS and other DELICATE INSTRUMENTS

Slipped with the fingers directly on the filament terminal of any standard bulb used in any standard socket, this device gives positive protection against any excessive amperage.

Even an accidental "short" cannot get by this fuse.

The Radeco Safety Fuse does not affect the efficiency of your set, and saves much time and money.

Come only in packages of four

4 for \$1

Order by mail or from your dealer

When you order, please specify what tube fuses are for.

Special CRYSTAL DETECTOR SETS

Complete with Variable Condenser, Vario Coupler, Tapped Primary, Buzzer Test, Cord Tipped Jacks for Phones, Bakelite Panel and Grade A Crystal

\$20

UNIT VAR 45V "B" BATT. \$3⁶⁰

CARBON RHEOSTAT....\$1⁵⁰

(ADJUSTING TO .01 AMP)

LIGHTNING SWITCHES..\$2⁷⁵

(600V-100 AMP)

KEYSTONE ARRESTERS..\$1⁷⁵

HOLTZER-CABOT PHONES \$8⁰⁰ PR.

(2200 OHMS)

CLAPP-EASTHAM HR REGENERATIVE RECEIVERS

New Mahogany Cabinet

\$40 | 2 Step Amplifier To Match **\$40**

We carry a complete stock of parts and sets at standard prices. Order from any standard catalog

RADIO EQUIPMENT CO.

630 Washington St. - - - Boston, Mass.

New England's Oldest Exclusive Radio House

Deposit required on C.O.D. orders.

Deposit required on C.O.D. orders.



Introducing
ROLLER-SMITH
UNIVERSAL Type
Radio Telephone Receivers

"UNIVERSAL" because they give equally good results with crystal or vacuum tube sets and are also *particularly* well adapted for loud speaking units. They are highly sensitive and perfectly matched. They reproduce without distortion from the highest to the deepest notes.

The design and workmanship are of the high standard which is characteristic of all Roller-Smith products.

Send for Bulletin No. V-20. It's free

ROLLER-SMITH COMPANY
 Electrical Instruments, Meters and Circuit Breakers



MAIN OFFICE:
 15 Barclay Street, NEW YORK

WORKS:
 Bethlehem, Pennsylvania

Offices in principal cities in the United States and Canada

hearing a set like this can tell how free from noise it is. A switch throws the batteries from the transmitter to a power amplifier. One light is left in series with the battery at all times when the battery is not in use; this keeps it up when wanted.

If your local battery man is liberal-minded, he will give these junk plates to the experimenter, if told what they are to be used for. In any case the plates will not cost much at junk prices. They are only worth about 2c per pound as junk. The sheet lead may be procured from the local plumber, and the electrolyte and separators from the battery man.

A word of caution may not be amiss: Never discharge the battery at any higher rate than necessary; do not charge too rapidly; do not let the battery stand any length of time without being charged. This causes sulphatation. Sulphate is a white substance that collects on the plates. Its presence will not allow the acid to act on the active material.

Kite Aerials for Portable Sets

By **GEORGE M. BRAMANN**

MANY amateurs owning very complete and excellent receiving apparatus fail to realize the fun that can be derived from portable sets, such as those described in RADIO NEWS in the last few months.

They may often have seen them or thought of building their own, but the trouble of obtaining an antenna worth while, so that, if a

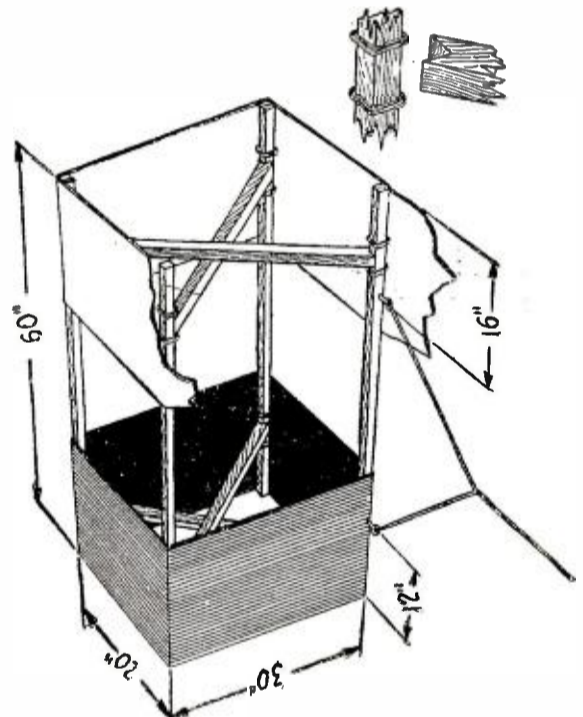

Such a Kite May be Used to Support an Aerial During the Vacation When at Camp.

storage battery could not be carried, a crystal detector might be used, has deterred many a radio enthusiast from enjoying his hobby while on the trail or at camp.

The easiest way to erect an aerial in the open, when one has not the time or the means to climb high trees, poles or other objects, is to put up a kite, using a copper or other convenient metal wire for the kite-line and also as the aerial.

All one has to do, once the kite is raised, is to connect the kite-line to the aerial connection of the set, drive a ground rod in the earth, put on the phones and listen in.

The best kind of a kite to use for this purpose is a collapsible box kite. The following measurements give all the information necessary to construct a kite of great pulling power and good stability.

First, make four corner sticks, 3/8" square and 60" long, from clear, straight grained wood free from knots.

Then make the four cross sticks also 3/8" square, but only 30 3/4" long. The four sticks, placed between the four corner sticks, hold the cloth stretched taut while it is in the air and may be readily removed so as to roll the kite up to carry from place to place. The ends of these sticks should be

Radio Motors and Generators

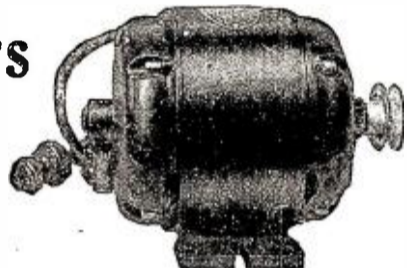

at Lowest Prices Ever Quoted

We offer prompt delivery of the following high class guaranteed power units:

1. **Synchronous Motor**
 For operating spark-gap. 1/8 H.P., 110 volt, 60 cycle, A. C. **\$20.00**
 2. **Motor-Generator Set**
 For charging "A" Batteries, 110 volt, 60 cycle **35.00**
 3. **Combined Motor and Generator**
 With low voltage for charging "A" Batteries, and 500 volts for broadcasting. 1/2 H.P., 110 or 220 volt, 60 cycle, A. C. . . . **100.00**
- General Purpose Motor**, for operating ventilating fans, drills, small lathes, household washing machine, cream separators, etc., 1/4 H.P., 110 volt, 60 cycle, split-phase, A. C., operating 1740 rpm. . . . **\$13.50**

Prices on motors of other sizes and types furnished on application

NORTHWESTERN ELECTRIC COMPANY
 412 South Hoyne Avenue **Chicago**

"RADIO TELEPHONY FOR AMATEURS"

By **STUART BALLANTINE**
 Formerly Expert Radio Aid U. S. N.

is the book that tells the how and why of radio telephony. Written so you can understand it fully. The biggest help to the amateur operator. 200 pages, freely illustrated.

\$1.50 net, by mail \$1.65
 Send for your copy

DAVID McKAY COMPANY
 Philadelphia



Every Crystal Guaranteed Perfect and ALL-Sensitive

Galena Crystal, Mounted **35c**
 Galena Crystal, Unmounted **25c**

IMMEDIATE DELIVERY

Manufacturers, Jobbers, Dealers, write for quantity prices.

GALENA CRYSTAL MFG. CO.
 464 Bushwick Ave. **Brooklyn, N. Y.**

notched so they will fit snugly against the corner sticks.

Ten inches from the end of each corner stick wrap two narrow rows of tape, leaving 1/2" between them, so the cross sticks will not slip out of place while the kite is in the air.

The illustration shows this detail clearly, the upper front cloth plane having been omitted in the drawing to show the interior construction.

The covering of the kite should be either muslin or cheesecloth, two strips 20" wide and 8' 6" long being required. The cloth is tacked to the corner sticks and then stretched tight by the cross pieces.

The center band is made by fastening two small screweyes into one of the corner pieces, 16" from one end and 12" from the other. A loop of wire about 10' long is fastened between these two, and the kite string is fastened to the loop.

For an aerial No. 24 or No. 22 B. & S. copper wire is suitable, one-half to three-quarters of a pound being all the wire needed.

Two of these kites may be flown tandem-fashion in the following manner: Put up the first kite and let out about 200' or 300' of wire. Then put up the second kite about 50' and join the two wires to one side of a cleat insulator. Fasten the other side to the main kite-line, and the length of wire used in raising the two kites will then not add to the wave-length.

If the kite is flown on too long a line, the wave-length will be very high, but this may be reduced by the use of a series condenser.

THE WIRELESS TELEPHONE

By DORIS BENNETT

I
When there's a record on the "Vic"
And you are in your chair,
When you are comfy and just so,
And wifey doesn't care,
Now don't you just begin to rave
When wifey calls, "Oh, Joe,
That record is a cracked one and
The 'Vic's' refused to go."

II
So when you've fixed the blooming thing
And it's all right again,
And you are sitting down to read
Before you've counted "ten"
Appears your wifey at the door,
Who says, "Oh, hubby, dear,
You didn't wind the phonograph.
It's running down I fear."

III
Now Jones next door, he has it soft.
He's bought a radio thing,
And all he does is tune it up
And list's to people sing.
Sometimes a man will play a piece
Two hundred miles away
And Jones he sits and listens to
The tunes the man will play.

IV
Now ain't it grand and glorious
To lay back when you please
And let another wind a "Vic"
While you are at your ease?
(Very good. But Doris evidently never had to "wind" up a three-step amplifier!—Editor.)

BIG RADIO STATION FOR PAGEANT OF PROGRESS EXPOSITION

A big broadcasting and receiving station will be erected on the Municipal Pier at the forthcoming Pageant of Progress.

Over one hundred dealers, manufacturers and radio engineers met at the Hotel Sherman and decided to put forth their best efforts to "surprise Chicago" with a monster radio exhibit. There will be a conference of the world's best known radio experts at the Pier early in July, when many new devices will be shown, contests of various types and other features. George E. Foster, of the Commonwealth Edison Co., has charge of the arrangements.

THE NEW RICO TRI-POLE DOUBLE HEAD 'PHONES

Mark a new advance in telephone receivers. These receivers are built on a radically different plan than all other receivers. *The pull on the diaphragm is where it should be*—in the mathematical center of the diaphragm.

RICO receivers "talk for themselves." A trial will convince you. Super-sensitive, especially designed for broadcast work—sounds are brought in sharp and clear. Not a receiver of extraordinary sensitiveness, but an all around receiver whether used for broadcast radiotelephone work, or for long distance radio telegraphy.

OUTSTANDING MECHANICAL FEATURES

Lightness, Stability, Aluminum shells. Non-rusting diaphragms. Guaranteed tungsten magnets. Neat, black mercerized cord. Head band adjustable not only to every size head but *the two bands are adjustable as well*; the only head band made in this manner. Sanitary soft rubber covering that can be washed, will not catch the hair—especially appreciated by ladies.



PATENTS PENDING

RESISTANCES: 2,000 and 3,000 ohms. Can be made up to 6,000 ohms if desired.

PRICES { "Rico" TRI-POLE Head Sets, 2,000 ohms, \$6.50
"Rico" TRI-POLE Head Sets, 3,000 ohms, 7.50

DELIVERY NOW. We have an especially attractive proposition to jobbers and dealers.
Wire or write to

RADIO INDUSTRIES CORPORATION

131 Duane Street

New York City

RADIO DEALERS

We are Jobbers of Reliable Radio Apparatus and Parts, to Dealers, Schools, Colleges and Experimenters

CITY SUPPLY CO.

56 Warren St. (Telephone 6613 Barclay) New York

A welcome addition to your library! Send \$2.50 today, plus postage for 7 pounds, and your copy of bound volume No. 2 of Radio News will come forward by return mail.
Experimenter Publishing Company, Inc. 53 Park Place, New York City

"Everett" Double Radio Phones

"When better phones are built we will build them"

Loud in tone
—
Sensitive to weak signals
—
Will withstand amplification without distortion

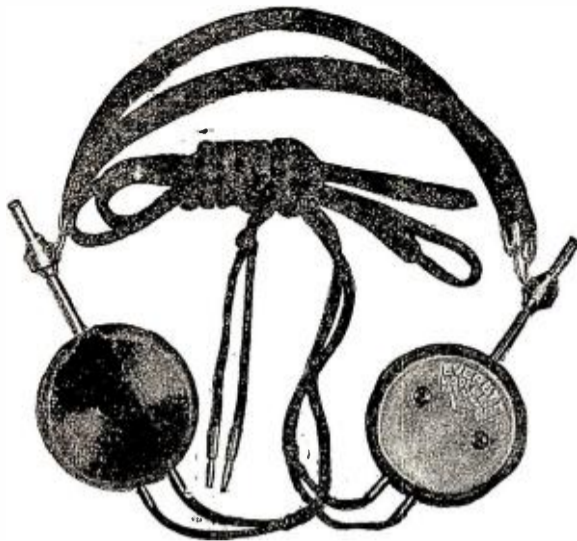

Approved by professional and amateur Radio Experts throughout the country

List \$8.50

On account of their supreme quality you will **EVENTUALLY** buy—why not **NOW**

AT ALL DEALERS

Everett Electric Corp. 320 Broadway, NEW YORK, N. Y.

Combining the Long and Short Wave Sets

By JOHN P. MEAGHER

IN almost all pictures of amateur stations it will be noted that two receiving sets are used. One for short waves and the other for long waves. Of course some sort of switching arrangement is used, but why not combine the two sets and provide a simpler means of switching? Fig. 1 shows how this is

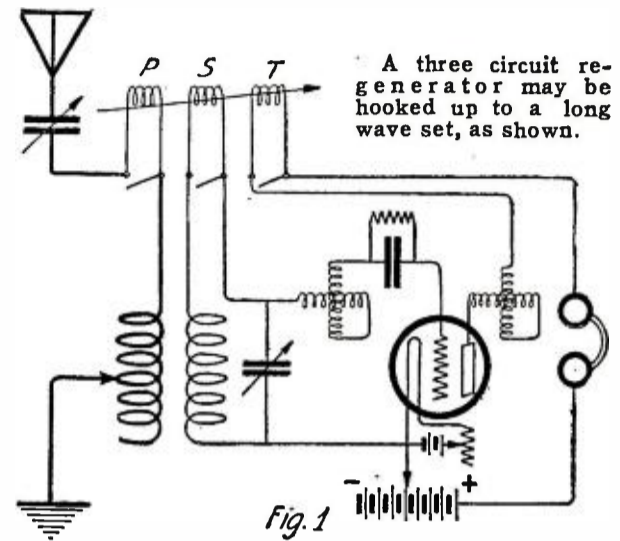

done on a three-circuit receiver. One advantage is that the two condensers may be used with the short-wave set and the variometers may be used to tune the long-wave set.

Fig. 2 shows how a two-circuit receiver

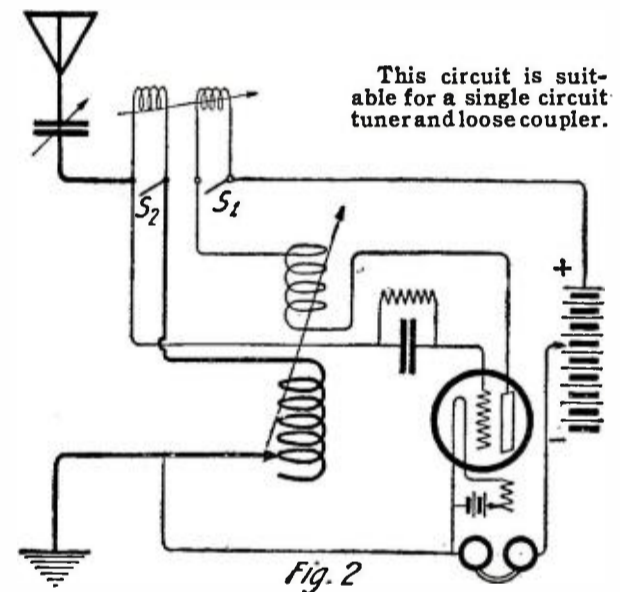

might be altered for the reception of longer waves. In this case two honeycomb sockets, one stationary and one movable, are used. The switches S1 and S2 short the long-wave coils, and the original circuit is then unaltered.

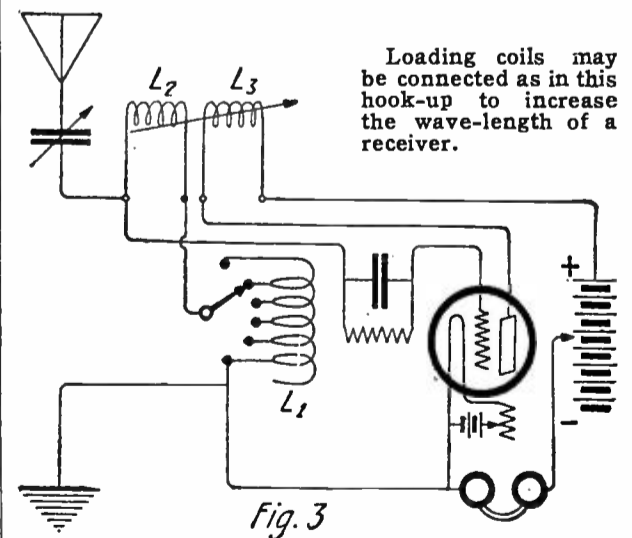

Following out this scheme, a receiving set of remarkable simplicity may be constructed by the method outlined in Fig. 3. Here L1 is a coil of wire consisting of 60 turns of No. 22 D. C. C., tapped every six turns; this coil may be mounted in the rear of the panel. L2 should be a honeycomb of 25 turns, and L3 a similar coil, but of either 50 or 75 turns. Now by changing the switch S1 the wave-length will extend from about 200 to 800 meters. If the regular coils were used to

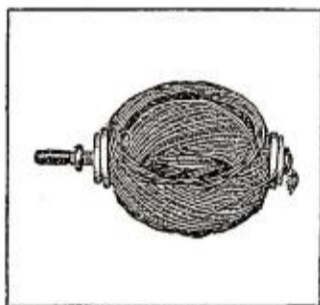

A Better Variometer

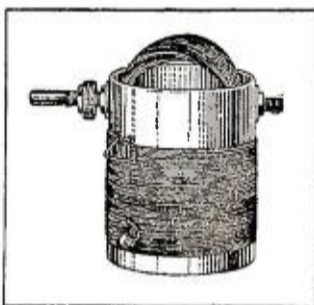

Estru Lattice Variometers and Variocouplers are small, compact instruments with no unnecessary framework, which makes them most easily wired.

Maximum efficiency by lumped inductance and low distributed capacity. Sharp tuning. Ideal for portable sets and for those who assemble their own, because of easy accessibility.

Immediate Delivery

- Variometer - - \$5.00
- Variocoupler - - 4.50

Mail orders promptly filled
Send for our new catalog

Dealers: Write for our proposition

A COMPLETE LINE OF RADIO SUPPLIES

NORTHERN RADIO SUPPLY CORPORATION

542 West Washington Street

Chicago, Illinois



Wireless Supplies and Equipment at Wholesale

MORSCAN RADIO CO.
196 Market Street, Newark, N. J.

"CHI-RAD" RADIO SUPPLIES

COMPLETE SETS
MATERIAL AND PARTS
EXPERT ADVICE
EVERYTHING RADIO

Oldest Radio House in Chicago

Come and see us for your Radio Equipment—we'll give you service you will like.

Chicago Radio Apparatus Co., Inc.
415 So. Dearborn Street
CHICAGO, ILL.

change the wave-length, at least two more would be needed. You may make L1 about 200 turns, but a larger coil will most likely be needed in the tickler socket. The most important thing in a honeycomb set is to have the coils aiding each other.

The New York Radio Exhibition

(Continued from page 243)

examine the exhibits without discomfort.

Amongst the exhibits themselves there was, of course, the usual array of freak receivers. Miniature crystal receivers were successfully hidden in harmless tie-pins and necklaces. At the next show we fully expect to find them stowed away in goloshes and shirt-buttons. One exhibitor, by an ingenious arrangement, succeeded in disguising a tuner, a detector and two-stage amplifier to appear in the form of an electric table lamp with a light inside and everything. The upright support of the lamp was in the shape of a horn to which was attached the telephone receiver. This should undoubtedly prove a boon to the inveterate practical joker who will be able to bewilder his friends with the mysterious music and reveal its source amidst acclamations of surprise.

Amongst the real radio exhibits, a new design of receiver, enclosed in a handsome period cabinet, attracted considerable attention. The unique feature of this receiver is the fact that there are absolutely no outside connections. The loop, batteries, amplifier and loud speaker are all included in the cabinet. The spiral loop is wound on a frame which fits inside the cover. This frame is mounted on hinges and permits the loop to swing out from the cover, to take advantage of its directional properties. The materials used in the amplifier are of good make and the manufacturers claim that, under the adverse conditions of a test made in Times Square, New York, radiophone was received 150 miles on the small loop in the cabinet, loud enough to be heard above the roar of traffic. As the instrument must have been entirely surrounded by high steel buildings, this reception is quite good.

Another loop receiver, enclosed in a small suitcase, was also very interesting. This receiver was very well designed in a compact form. It employed three stages of tuned radio frequency amplification. A small loop was enclosed in the cover of the case and also a flat-shaped horn to which was attached a Baldwin phone. Very good results were obtained with this unique receiver.

NATIONAL RADIO DEALERS ASSOCIATION FORMED—DEALERS MEET IN CHICAGO TO ORGANIZE

One of the latest steps taken in radio activities was the formation here of the National Radio Dealers Association, with headquarters at 10 North Clark Street, Chicago, and district offices in New York and San Francisco.

The original group constituted the commercial membership of the American Radio Association and consisted of about 200 dealers. About 4,000 radio dealers in all parts of the country have been added by invitation.

The new association has been chartered under the laws of Illinois as a corporation not for pecuniary profit, is registered in the corporation department of each state and has applied for a national charter. The purpose of the association is to protect and de-

WESTINGHOUSE RADIO BATTERIES



Eliminate all Battery Troubles from Radio Sets

The Westinghouse "A" Battery is a full capacity, low voltage, slow discharge, long-life storage battery built exclusively for radio work.

For "B" battery requirements Westinghouse has perfected a baby storage battery. No more throwing away exhausted cells.

No more continuous "B" battery expense.

The Westinghouse "B" is a permanent battery. It never has to be replaced. It will discharge its load with constant, steady voltage. Then it can easily be recharged. It gives continuous service to the point of exhaustion without growing "scratchy." If your vacuum tube is inclined to be noisy you can adjust the contact on the Westinghouse "B" to take off the exact voltage the V. T. requires.

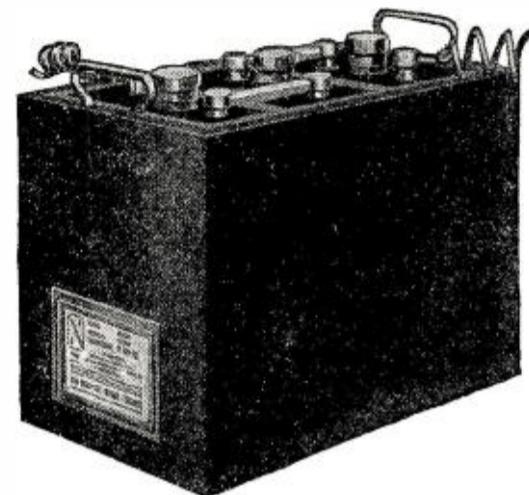

Get a Westinghouse "A" and "B" from your dealer or the nearest Westinghouse Battery Service Station and eliminate all your radio battery troubles.

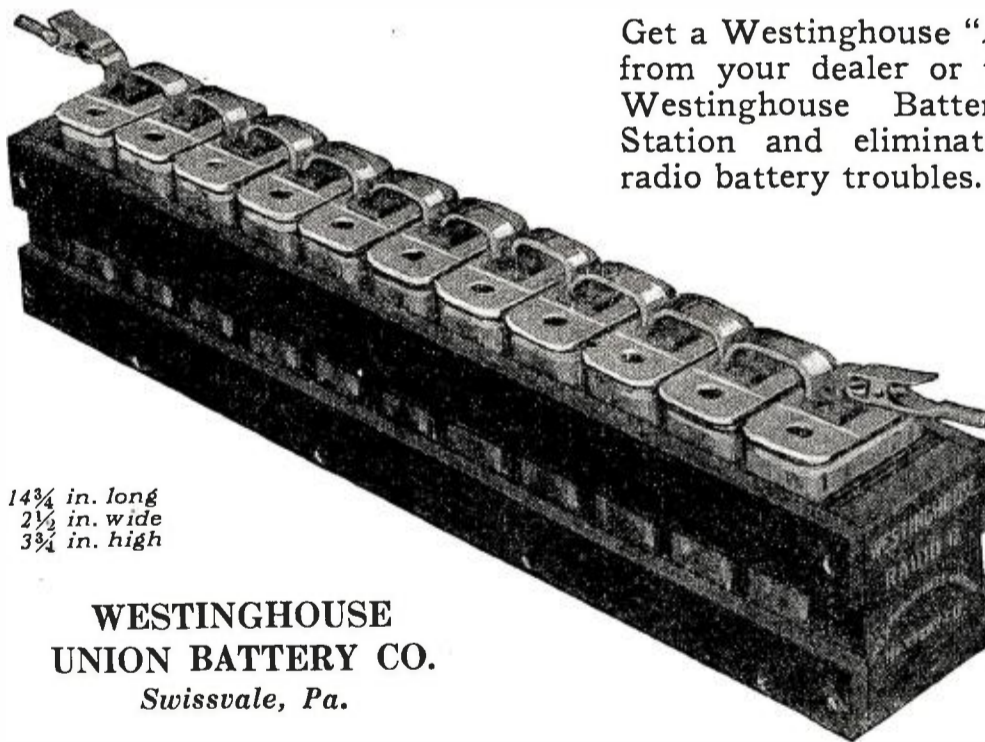

14 3/4 in. long
2 1/2 in. wide
3 3/4 in. high

WESTINGHOUSE UNION BATTERY CO.
Swissvale, Pa.

"The Best Westinghouse can build."

RADIUM JEWELL DETECTOR

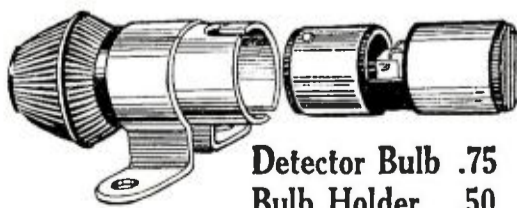

Detector Bulb .75
Bulb Holder .50

Requires no adjusting. Only occasional tuning, which can be done in one second.

No battery used. Can be applied to any receiving set. Takes the place of crystal detectors. No more fiddling around for sensitive spots; just pick up the phones and listen. Worth several times the price asked for this new invention. If your dealer can't supply, we will mail direct.

Dealers write for proposition

Newark Electrical Supply Distributor for New Jersey

Peerless Wireless Co., Detroit—Distributors for Middle West and Canada

STAR MFG. CO.,

Newark, N. J.

MAKE YOUR OWN

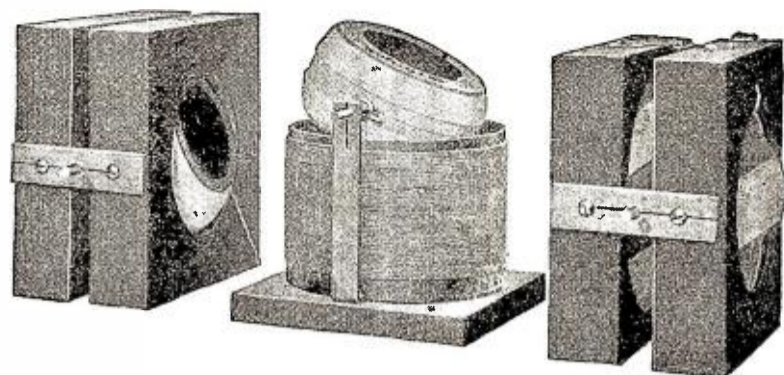

VARIOMETERS and VARIO COUPLERS

Parts for ATLAS Variometers and Vario Couplers, Coils wound, and shafts in place, ready to assemble—\$3.00 each.

THE AMERICAN RADIO SALES & SERVICE COMPANY, INC.
51-52 Dickson Building Mansfield, Ohio

POPULAR RADIO BOOKS

The How and Why of Radio Apparatus

H. W. Secor, E.E.



This newest book on radio matters fulfills a distinct gap in wireless literature in that, while the treatment is made as understandable and as free from mathematics as possible, it at the same time incorporates a wealth of technique and instruction for the Radio Amateur—the Radio Operator—the Installation and Designing Expert—as well as teachers and students of the subject in general.

A glance at the following list of chapters gives but a very scant idea of the extensive and useful radio knowledge provided in its text:

The Induction Coil; The Alternating Current Transformer; Radio Transmitting Condensers; The Spark-Gaps; Radio Transmitting Inductances; Radio Receiving Tuners; Radio Receiving Condensers; Detectors; Telephone Receivers; Radio Amplifiers; Construction of a Direct Reading Wavemeter and Decimeter; Antenna Construction; The Calculation and Measurement of Inductances; Appendix containing very useful tables, covering all subjects treated in this very unusual book.

Cloth bound in Vellum de Luxe. Gold stamped and hand sewed; has 160 pages. Size of book 6x9 inches. The How and Why of Radio Apparatus. **\$1.75**

Postpaid
Same Book, Limp Bound, Colored Cover, 75 cents.

Design and Construction of Audion Amplifying Transformers

Radio and Audio Frequency Type

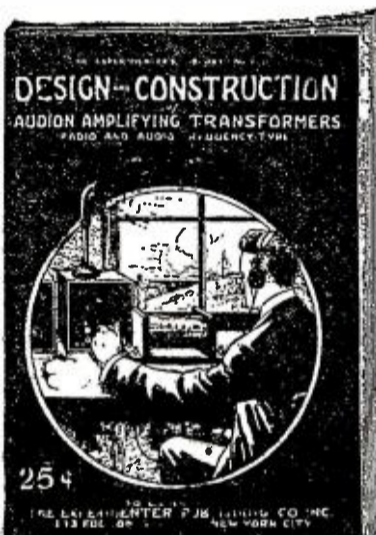

This latest and important book by Mr. Edward T. Jones, late Associate Editor of Radio News, will be of great interest to all radio amateurs throughout the land. The transformers shown in this book have never been described in print before, and have usually been considered a manufacturer's secret. Anyone who has several vacuum tubes cannot afford to do without this book because it will enable him to build the necessary amplifying transformers very readily. The designs are very simple and rugged, and anybody can make them without trouble.

The book is printed on good paper and has an attractive cover in two colors. Paper bound. Size 5 ins. x 7 ins. Contains many illustrations, diagrams and working data necessary to build the transformers. Price, Postpaid, **25c**

THE EXPERIMENTER PUBLISHING CO.

Book Dept., 53 Park Place

NEW YORK

HEAD SETS

"Ampl-Tone"

\$8.00 List 2200 Ohms Guaranteed

Sensitive and Durable

We Can Make Delivery
Our Only Product

FRENCH MFG. CO.

1931 BROADWAY NEW YORK

Write Us for Distribution

"COPPERWELD"

TRADE MARK REG. U.S. PAT. OFF.

Has Underwriters' O. K.
Copperweld Antenna Wire
Copperweld Lead-in
and Ground Wire
Copperweld Ground Rods

BUY "COPPERWELD" IN CARTONS

At All Radio Stores

COPPER CLAD STEEL CO.

BRADDOCK, P. O.

RANKIN, PA.

velop the commercial interests of its members, to cooperate with all radio bodies and to establish a definite policy to the buying public.

PLANS NATIONAL CONVENTION

Plans were discussed for a national convention to be held in Chicago, which will be composed of a representative from each dealer in the country. This convention will institute policies and recommendations to be used as a basis of information for a national dealer's, manufacturer's and jobber's policy toward the public.

Edward C. Talbott, Jr., executive officer of the new organization, in an announcement, states:

"The Bureau of Standards, Department of Commerce, in a letter endorsing the American Radio Association, stated: 'The Government believes very thoroughly in coordinating the various phases of radio work in this country and is glad to note that a number of the stated purposes and aims of the American Radio Association are along these lines.' The new association will be a long stride toward the accomplishment of this aim and the elimination of the present commercial radio confusion. The radio public can purchase apparatus from the members of the new association with the utmost confidence, as manufacturers and dealers who produce and sell inferior and inadequate apparatus with no guarantee or scientific construction, and those interested in only a temporary 'get-rich-quick' policy in order to take advantage of the uninformed radio public will be excluded."

The new organization will be extensively advertised in a national publicity campaign. National expositions will be held at the time of the annual meeting to bring the various commercial interests together. An information bureau posting the membership on all radio developments will be established. A credit bureau will also be organized for the exchange of credit information. All reputable dealers interested in the scientific, commercial and public permanency of radio are eligible to membership.

OHIO STATE UNIVERSITY INSTALLS BROADCASTING STATION

Within the next year Ohio State University at Columbus, Ohio, will have one of the best and most powerful radio broadcasting stations in the country, if plans now being worked out are consummated. The proposed plant will be built with funds provided solely by members of the Ohio State Alumni Association. It will be erected on the campus, space and housing facilities being furnished by the university.

Funds for the new station are now being collected, and according to announcement of alumni authorities the appeal is meeting with ready response on the part of former students solicited.

To obtain information with which to build a station that will rank second to none in the country, Professor Frederick C. Blake of the Physics Department and Professor Roy A. Brown of the Department of Electrical Engineering, College of Engineering, have been making a survey of other large broadcasting plants in the country, and shortly will make a report on their recommendations as to the construction of the university plant.

The Columbus (Ohio) *Evening Dispatch* has promised its cooperation in the furnishing of entertainments, etc., after the station is completed, the newspaper agreeing to put on one or more programs each week in addition to giving news bulletins, market reports, concerts, etc.

A unique side-light of the canvass for funds among the alumni is the fact that fully 80 per cent. of those solicited so far are either owners of radio sets or have such an interest in wireless that they attend regular concerts at plants owned by friends.

A welcome addition to your library! Send \$2.00 today, plus postage for 7 pounds, and your copy of bound volume No. 1 of Radio Amateur News will come forward by return mail. Experimenter Publishing Company, Inc. 53 Park Place, New York City

This despite the fact that the names were selected at random by the committee.

The proposed station will be especially ideal for broadcasting of matter to Ohio points, inasmuch as it will practically be in the center of the state.

State officials are interesting themselves in the proposal, as they see the station of inestimable value in case of disasters, such as the 1913 flood, when many cities were under water and were unable to communicate with outside points.

ENGLAND TAKING UP RADIO

Considerable interest has been shown by the British public in the spread of wireless telephony and telegraphy in the United States, says the Electric Supplies Division of the Department of Commerce, and a campaign has been started for the development of similar facilities in Great Britain. In this connection there may possibly be a market for inexpensive American radio outfits.

The policy of the British government with regard to amateur wireless stations, as recently expressed by the Postmaster-General, was sympathetic and aimed to facilitate the establishment of wireless stations, subject to proper regulations to avoid "jamming" and interference with the government services. Under these conditions it has been decided to allow the establishment of a limited number of radio-telephone broadcasting stations.

The country will be divided roughly into areas, centering upon London, Cardiff, Plymouth, Birmingham, Manchester, Newcastle, Glasgow or Edinburgh (but not both) and Aberdeen; and one or more broadcasting stations will be allowed in each of these areas. Permission for these stations will be granted only to British firms who are bona fide manufacturers of wireless apparatus. In order that each service shall not interfere with the efficient working of other services, licenses to these British broadcasting firms will not be granted freely. The stations will be limited to a power of 1½ kilowatts and furnished with wave lengths which should not interfere with other services.

One of the large London department stores has recently begun to demonstrate an inexpensive receiving telephone apparatus of British manufacture to sell for 6 guineas (equivalent to \$27.75 at exchange rate of \$4.40).

DUAL RADIO BILLS IN CONGRESS —DEPARTMENT OF COMMERCE PLANS FOR REGULATING BROADCASTING

The mystic symbols "S-3694" and "HR-11964" designate official Government papers which bear directly on the future development of radio in this country. These papers are exactly alike and comprise the proposed radio legislation introduced in Congress. The first bill was introduced by Senator Kellogg of Minnesota on June 8 and referred to the Senate Interstate Commerce Committee, while the House bill, prepared and introduced by Congressman White of Maine, was presented on June 9 and turned over to the Committee on Merchant Marine and Fisheries. Mr. White is now more sanguine about the early consideration of his bill by this committee, as the Ship Subsidy bill was reported out recently, clearing up one of this committee's big problems.

At the Department of Commerce radio officials are waiting the enactment of legislation so that they can clear the aerial traffic, so to speak, especially along the route of the 360-meter wave on which all 348 broadcasting stations are now operating. With the passage of the bill, and there seems little doubt that it will pass, as there are virtually no opponents to it, a conference in Washington of all radio inspectors will be called to meet with the new radio advisory committee of 12 authorized in the bill to aid Secretary Hoover in enforcing the legislation.

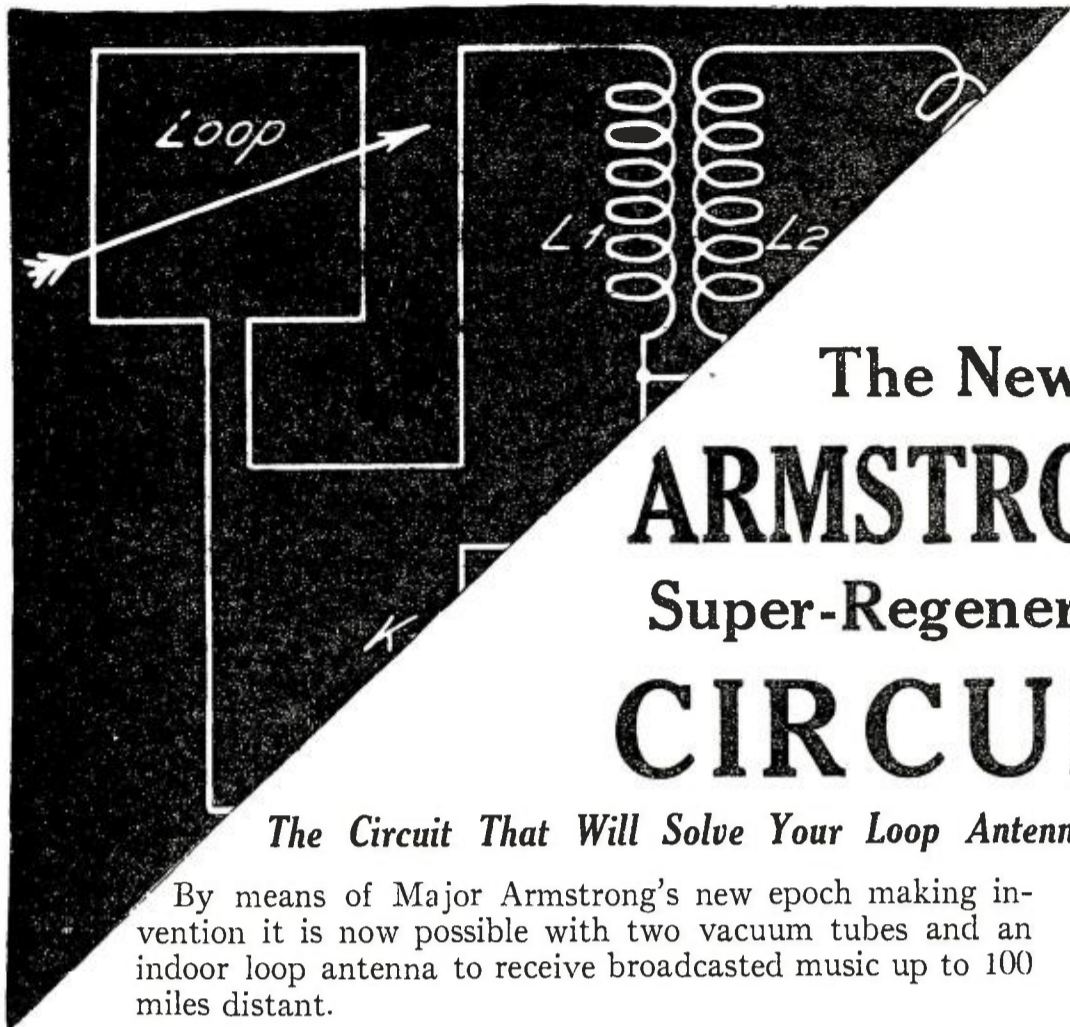

The New
ARMSTRONG
Super-Regenerative
CIRCUIT

The Circuit That Will Solve Your Loop Antenna Problem

By means of Major Armstrong's new epoch making invention it is now possible with two vacuum tubes and an indoor loop antenna to receive broadcasted music up to 100 miles distant.

Our engineering department has compiled a pamphlet that gives an exposition of the theory of operation with full working directions, etc. A large blueprint is included with this pamphlet. Our engineering department has actually operated the new circuit, of which little is known as yet. In this pamphlet will be found the correct circuits, as well as the proper instruments, inductances, etc. In most instances, it is possible that with your present instruments you can achieve these wonderful results.

25c

Order from your local dealer, or direct from us.

The E. I. Co.

233 Fulton Street
New York
City

ARMSTRONG
"SUPER-REGENERATIVE"
RECEIVER

Radio Fans

Ask Your Dealer to Show You the

MOON RADIO CORPORATION

"B" LINE OF Receiving Sets

Prices, **\$35 to \$105**

Compartment for "B" Batteries and Phones

Write Us for Catalogue

DEALERS: SOME CHOICE TERRITORY STILL OPEN

Moon Radio Corporation
Manufacturers of Ultra Fine Receiving Sets

12 DIAGONAL STREET
LONG ISLAND CITY, N. Y.

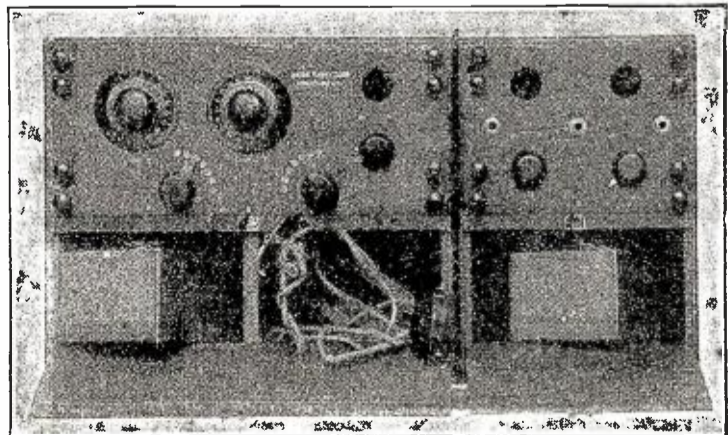

COMMERCE RADIOPHONE

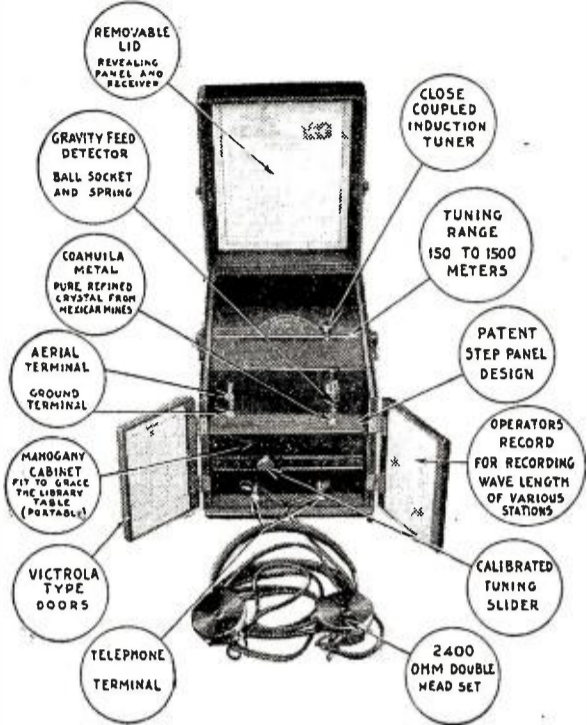

"The Best and Clearest Crystal Receiving Set"

Notice all the features of this handsome set—the finish of mahogany—the 2400 Ohm double head set—the wave length adjustment of 150 to 950 meters. Long range—receives words and music perfectly up to 30 miles—signals up to 300 miles. Full directions given. Anyone can install and operate.

Order Today - Send No Money

If your dealer does not carry the Commerce, don't be satisfied with a less satisfactory set. Ask us to send you one today C.O.D. with a positive guarantee of satisfaction or money back.

Distributors and Dealers

You will want the Commerce. Write quickly for our attractive proposition. Your territory may be open. *Better wire or phone!*

\$25 COMPLETE
125 ft. 14 ga. antenna wire. Insulators. Double tuning sliders. Double 2400 Ohm head set. *Everything—ready to install.*

COMMERCE RADIOPHONE CO.
DETROIT - - - MICHIGAN



Andion Bulb Socket, No. 1150 latest in absolute reliable contacts. Study construction shown in diagram. "ON TOP OF ALL" quality, and sells for \$1.00 only. Highly nickel polished & polished black compo base.

Rheostat, No. 1175 is constructed with metal bearing for shaft. Therefore more durable than others. Designed for use on panel or table. Resistance 5 ohms. \$1.00 postpaid.

Nickel or Brass
No. 7160 \$1.80-103 No. 7138 \$1.30-100

CONTINENTAL ELECTRIC COMPANY
117-119 E. 129th St., New York, N. Y.

Write us for round or square brass rod, brass tubing, and all kinds of machine screws and nuts. Machine screw taps, any gauge or thread. Our Laboratory torch for soldering is the best tool of its kind made.

ANGIERS, U. S. A. Streator, Ill.
Bruce St. Plant.

To date, no one will hazard a guess as to the personnel of the committee, although it is thought that the six governmental representatives will include a number of the officials who have already cooperated with the Department in its recent conference on radio wave distribution and the necessary legislation. The following men were conspicuous in that work and may serve again: Dr. S. W. Stratton of the Bureau of Standards; Major-Gen. Geo. O. Squier, Signal Corps; the Chief of the Naval Communications Service; Mr. J. C. Edgerton of the Post Office; Mr. W. A. Wheeler of the Department of Agriculture, and D. B. Carson, or another representative of the Department of Commerce Radio Section.

It is even more difficult to predict the members to be selected from civil life, as there are many interests to be represented by only six men. The manufacturers of radio apparatus must be included, as well as trans-oceanic operators, broadcasters, amateurs, radio engineers, commercial operators and probably educational institutions and news agencies, which make eight interests. This shows the difficulty which may be encountered in making a fair distribution, although one man may be found who can represent two of the classes vitally interested in radio.

One of the first problems to be encountered by the Department will be the assignment of new wave lengths so that interference will be decreased, and then the problem of whether to zone the country or classify the stations will come up. If waves are assigned by zones, it is pointed out local interference will become greater, whereas if wave lengths are distributed to different classes of operators, as, for example, one wave to newspapers and one to entertainment, the air would be jammed again with many news stories on one wave length and with music and song on another. Naturally there are not enough waves between 285 and 485 meters to give every operator of the 348 broadcasters a specific length, and so it would appear that a plan of combined classification and zoning would have to be tried out and regulated further by specific hours for operation. It is thought, however, that by using the system of classification detailed by the full radio committee recently and a zoning system with perhaps the maintenance of local time schedules in cities where there are several broadcasting stations, much can be accomplished to clear the air.

ARMY SHARES ARLINGTON STATION

Through the cooperation of the Naval Communications Service, the Radio Section of the Signal Corps on June 5 acquired the use of part of the big Arlington Station for its chief sending station out of the Capital. Two sets will be used by the army exclusively, one tube set with 10 k.w. in the antenna and another with 20 k.w. in the antenna. The latter, used on about 3000 meter waves, should carry as far west as Omaha. Today the Signal Corps is using a 2 k.w. transmitting set at Arlington for regular traffic on 2650 meters, controlled from the radio headquarters in the Munitions Building.

The Government has saved at least \$50,000 by combining the Naval and Army sending stations at Arlington, it is said, as the Signal Corps station planned for the Washington barracks would have cost practically that much when the permanent installation was completed. Now the temporary station at the barracks has been abandoned and the permanent construction saved.

The navy will still continue to operate from its station at Arlington, using its own sets as previously, but has arranged to lend the Army Radio Section its big 100 k.w. spark set when necessary, as well as its arc set. Another combination has made possible the operation of the navy 1 k.w. tube set at Arlington by either the Naval Air Station at Anacostia or the Army Bolling Field for.

Recharge Your Battery at Home

Charges Both A and B Radio Batteries

Don't be without the use of your Radio Receiving Set while your battery is being charged. Get a Valley Charger and charge your battery right at home. Attach the Charger to your home lamp socket—attach the clips to the battery terminals and you will get a quick, tapering charge which just exactly charges your battery, but cannot overcharge or harm it in any way.

Will charge the A 6 volt battery at a 5 ampere rate, and the B 22½ volt battery at the required ½ ampere rate. 45 volt B batteries may be connected in parallel so that they can also be charged. **SATISFACTION GUARANTEED.** If your local distributor cannot supply you, write direct to

VALLEY ELECTRIC COMPANY,
Department R, ST. LOUIS, MO.

----- Mail the Coupon -----
Valley Electric Co., Dept. R, St. Louis, Mo.

Gentlemen: I am enclosing money order (or check) for \$18.00, for which send me a Valley Battery Charger with five-panel glass display case and indicator. If not satisfactory, I will return it and get my money.

Name _____
Address _____

\$18.00
F.O.B. St. Louis

Midwest Jr. Audion Receiving Set

This outfit mounted on solid mahogany, highly finished base and consisting of our junior 600 meter wave length Coupler wound with green silk covered wire and Formica Detector Tube panel enclosed in highly polished mahogany cabinet, equipped with Rheostat, grid leak, grid condenser, potentiometer and either binding posts or jack for phones. All nickel parts highly polished.

COMPLETE OUTFIT, \$22

Same as above, with crystal detector... \$14.00	Crystal Detector... \$1.75
Audion detector	Amplifier transformer... 4.00
Tubes..... 5.00	60 amp. ground switches..... 2.50
2200-ohm head set 8.00	Navy type, 2500 Meter loose coupler..... 11.00
22½ volt B. batteries..... 2.75	All sizes Formica panels.
21 plate condenser 4.25	
43 plate condenser 4.50	

SIEGAL ELECTRICAL SUPPLY CO.
Main 1364-1372, 154-156 W. Washington St., Chicago.

NOTICE

RADIO AND ELECTRICAL EMPLOYEES

WE wish a representative in every Radio and Electrical Manufacturing Plant everywhere, to secure yearly subscriptions to **Practical Electrics**—the most novel and most interesting magazine in the electrical field.

We pay big commissions—only a few hours work in your factory or at the noon hour—will pay you handsomely.

For details, sample magazine and order forms, write

Mr. C. J. Wolfe, EXPERIMENTER PUB. CO.
53 Park Place, New York

the transmission of messages to planes or short distances up to 250 miles. These stations will also conduct considerable meteorological work with the 1 k.w. set at Arlington.

NEW RADIO EQUIPMENT FOR ARMY PLANES WILL PLACE AMERICA FIRST IN THE AIR

America's aerial fleets, in the army at least, will soon be equipped with the best radio apparatus in the world, and will for that reason be superior to the aircraft of any foreign nation.

Service planes will soon be equipped with new combination radio sets capable of transmitting both telegraph and telephone messages between airplanes and the ground, or two planes in the air. The new sets are of three types, designed for pursuit, observation and bombing airplanes, and are the latest development of the Signal Corps Radio Section. Although the specifications have been drawn up and bids called for by the Signal Corps, no description of the new radio equipment has been released. It is said, however, that they are a big improvement on the sets now in use in the Army Air Service. The largest and strongest set, S.C.R. 135, designed for bombing planes, such as the dual-engined Martins, will have a radio telephone radius for plane-to-ground of about 75 miles and a telegraph radius from plane-to-ground of about 200 miles.

For pursuit planes, S.C.R. 133 is designed to give a reliable plane-to-plane telephone radius up to 5 miles. Set 134, for observation planes, like the DH-4s, will insure radiotelephony between two planes on the wing up to about 10 miles. The largest sets which are to be installed in the Martins, it is expected, will make aerial conversation possible up to 25 miles. In aerial radio work a trailing antenna is used as an aerial, and for a ground the metal parts of the plane.

Previously radiophone messages have only been carried on between planes over short distances, as in "voice-control" flying, where the commander of a squadron directs the maneuvers of his pilots, but with the new sets officers of the Army Air Service hope to employ radiotelephony to a greater extent and see far larger applications of radio in flying operations.

OVER 20,000 TRANSMITTING STATIONS

Total transmitting stations licensed by the Radio Section of the Department of Commerce now number 20,265. Of this number 3,572 are ship and commercial land stations, 11 transoceanic, 558 special land stations, including experimental and technical stations; 348 broadcasting stations and 15,776 amateur stations.

The amateurs licensed to transmit messages are grouped as follows in the 9 districts:

1. Headquarters, Boston, Mass.: Maine, New Hampshire, Vermont, Massachusetts, Rhode Island, Connecticut—2,490.
2. Headquarters, New York N. Y.: New York (county of New York, Staten Island, Long Island and counties on the Hudson River to and including Schenectady, Albany and Rensselaer) and New Jersey (counties of Bergen, Passaic, Essex, Union, Middlesex, Monmouth, Hudson and Ocean)—2,336.
3. Headquarters, Baltimore, Md.: New Jersey (all counties not included in second district), Pennsylvania (counties of Philadelphia, Delaware, all counties south of the Blue Mountains, and Franklin County), Delaware, Maryland, Virginia, District of Columbia—1,863.
4. Headquarters, Savannah, Ga. (Baltimore, Md.): North Carolina, South Carolina, Georgia, Florida, Porto Rico—342.
5. Headquarters, New Orleans, La.: Alabama, Mississippi, Louisiana, Texas,

ARE YOU USING THE RIGHT MATERIAL FOR YOUR RADIO PARTS?



**Has it high dielectric strength?
Does it withstand severe usage?
Has it a good finish?
Does it resist heat?**

RADIO engineers and manufacturers have found that C-H Thermoplax—the only Thermoplax made—is the best molded insulation. It is made in both the Milwaukee and New York plants of The Cutler-Hammer Mfg. Co., and in the allied plant of the Electroplax Co. of Toronto, Canada.

Delivery Assured

Three sources of supply are thus available, insuring production even in case of delays at one of the plants.

The C-H method of cold molding provides for big production per die—keeping your cost of dies low.

Sales engineers in all principal cities are ready to assist in designing parts.

- | | | |
|----------------|---------------------------------|-----------------|
| Knobs | Honey Comb Plugs | Condenser Boxes |
| Rheostat Bases | V T Sockets | Head Set Parts |
| Handles | Socket Bases | Adapters |
| Jack Boxes | Crystal Detector Caps and Bases | |

THE CUTLER-HAMMER MFG. CO.
WORKS: MILWAUKEE AND NEW YORK
OFFICES AND AGENTS IN ALL PRINCIPAL CITIES



1/4 in. Sliders—Brass, 20c; Nickel, 25c
1/4 in. Slider Rods—Brass, 15c; Nickel, 20c
Crystal Detectors, Nickel Plated on Mahogany Base, \$1.00
Double, Nickel Slider Tuning Coils, \$3.00
Contact Points, threaded with nuts, 20c dozen
Compo. Cap, Nickel Base Binding Posts, 7c each
Plain Nickel Binding Posts, 3 1/2c each
Liberal Discounts to Dealers
F. JOS. LAMB COMPANY
1960 FRANKLIN ST. DETROIT, MICHIGAN

OFFICIAL
RADIO BROADCAST MAP
(In Two Colors) 10 Cents Postpaid
Experimenter Pub. Co., 53 Park Place, New York

ATLANTIC JR.
CRYSTAL RECEIVER
Ready for Installation **\$18**
ATLANTIC INSTRUMENT CO., INC.
13-21 Park Row, New York

**Protect
Your VTs-**

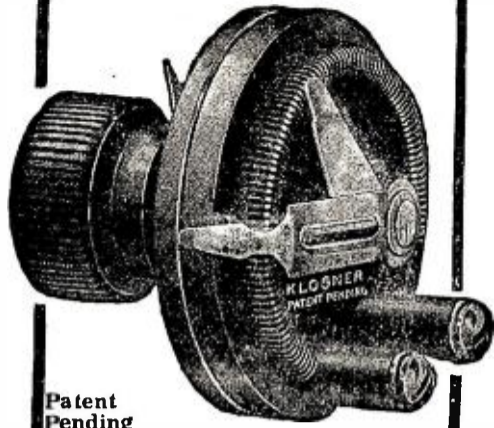

Patent Pending

**KLOSSNER
VERNIER
RHEOSTAT**

EVERY tube you have deserves a Klossner Vernier Rheostat. The Klossner wire wound feature produces a low starting current preventing sudden strain and thereby prolonging the life of the tube.

The Klossner provides micrometer adjustment for your critical detector tubes. One single knob controls both the rough and vernier adjustments. It is unsurpassed for loudest reception of telephone, and CW, and is essential for detector tubes of radio frequency amplification. Awarded the New York Evening Mail's Certificate of Excellence. Insist on the genuine—made only by the originators. Look for the name "Klossner" moulded on the base. The cost is no more than for other Rheostats without these exclusive features. At your dealer or send for interesting literature. Klossner Improved Apparatus Co., Dept. N, 2024 Boston Road, New York City.

Dealers: This is the fastest moving rheostat on the market. It is stocked by all leading jobbers. Get your supply from them.

**One Single Knob
No Sudden Strain**

\$1.50

RADIO PARTS

We are specialists in

Bakelite Moulding

Send Us Your Drawing or Sample

PROMPT Deliveries

THE RIDGELY TRIMMER CO.

Springfield, Ohio, U. S. A.

ANTENNA Special 100 Ft. No C.O.D. **WIRE**
 7-20 Bare .95; Tinned 1.10 Delivery
 7-22 Bare .60; Tinned .65 3 days
 14 Solid Bare .44; Tinned .48 P. P. Free
AMERICAN RADIO COMPANY
 Box 138 Baltimore, Md.

Tennessee, Arkansas, Oklahoma, New Mexico—740.

6. Headquarters, San Francisco, Calif.: California, Hawaii, Nevada, Utah, Arizona—1,676.

7. Headquarters, Seattle, Wash.: Oregon, Washington, Alaska, Idaho, Montana, Wyoming—732.

8. Headquarters, Detroit, Mich.: New York (all counties not included in second district), Pennsylvania (all counties not included in third district), West Virginia, Ohio, Michigan (lower peninsula)—2,567.

9. Headquarters, Chicago, Ill.: Indiana, Illinois, Wisconsin, Michigan (upper peninsula), Minnesota, Kentucky, Missouri, Kansas, Colorado, Iowa, Nebraska, South Dakota, North Dakota—3,030.

Broadcasting stations now total 348, representing all but 6 States of the Union. This number is over five times the total broadcasters listed by the Department of Commerce three months ago, and yet some people ask if radio is going to last?

During one week 22 new stations were licensed to broadcast news, government reports and entertainment. Stations in California, New York, Michigan, Kansas, Illinois, Missouri, Texas, Ohio, North Carolina, Washington, South Dakota, Maine, Minnesota and Indiana were authorized. Besides a number of radio and electrical concerns opening broadcasting stations, licenses were issued recently to a tabernacle in San Francisco, a trade journal in Chicago, a business college in Peoria, daily papers in Sioux Falls, St. Cloud and Houston and a Missouri College.

**LIST OF LIMITED COMMERCIAL
OR BROADCASTING STATIONS
LICENSED BETWEEN JUNE
10 AND 16**

KDZW—Claude W. Gerdes, San Francisco, Calif.

KDZX—Glad Tidings Tabernacle, San Francisco, Calif.

WFAF—Henry C. Spratley, Poughkeepsie, N. Y.

WFAC—Superior Radio Co., Superior, Mich.

WFAD—Watson, Weldon Motor Supply Co., Salina, Kan.

WAAF—Chicago Daily Drovers Journal, Chicago, Ill.

WFAK—Domestic Electric Co., Brentwood, Mo.

**RADIO
"A" BATTERY**

Guarantee Radio "A" Batteries give perfect service with minimum of attention. Handy, sure-contact screw post terminal. Leak-proof. Quickly recharged. Built to U. S. Govt. specifications. Prices: 6 Volts-60 Amp., \$13.50. 6 Volts-80 Amp., \$15.50.

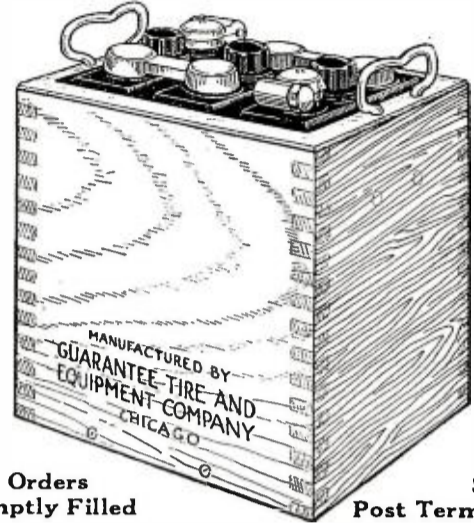

Mail Orders Promptly Filled

Screw Post Terminals

GUARANTEE TIRE AND EQUIPMENT CO.
3544-46 So. Michigan Avenue, Chicago

**Start a Radio Business of Your Own
"The RADIO TELEPHONE HANDBOOK"**

By H. G. Cison, M. E.

Tells How to Make Money Out of Radio

Full of practical, profitable ideas. Start while the field is new! Money back if not satisfied. Postpaid, \$1.00.
ALLIED ENGINEERING INSTITUTE, 1400 Broadway, New York City

43-plate Variable Condensers (.001 M.F.)... \$6.50
 25-plate Variable Condensers (.0005 M.F.)... 5.00
 11-plate Variable Condensers (.00025 M.F.)... 4.35
 3-plate Variable Condenser (used as a Vernier) 3.25
 Above prices include knob, pointer and dial
 Hard Rubber Panels for above .75

DISCOUNTS TO BONA FIDE DEALERS
IMMEDIATE SHIPMENTS

F. JOS. LAMB COMPANY
1960 Franklin Street Detroit, Michigan

**OFFICIAL
RADIO BROADCAST MAP**

(In Two Colors) 10 Cents Postpaid
Experimenter Pub. Co., 53 Park Place, New York

R. T. M. TUNER & DETECTOR

Has a Tuning range of 150-650 meters. Tuning is very simple, brings in the music sharp and clear. Cabinet has mahogany finish, panel is made of hard rubber and has also the appearance of mahogany finish. All wiring is in the back of the panel, thus giving it a very neat front appearance. The B battery is contained within the set and outlets for A battery leads in the back. Price..... **\$38.00**

R.T.M. two steps complete finish connected to the R.T.M. tuner by means of bus bars.... **\$38.00**

*Send for Dealer's
Proposition*

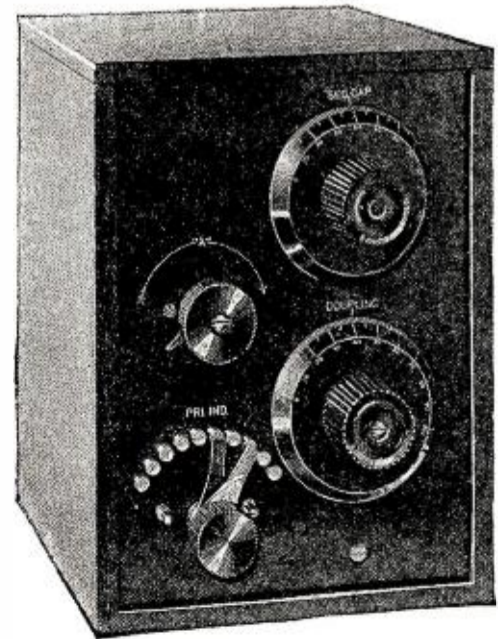

RADIO TELEPHONE MFG. Co.
150-152 Chambers Street NEW YORK CITY

- WFAH—Electric Supply Co., Port Arthur, Texas.
- WCAH—Entrokin Electric Co., Columbus, Ohio.
- WFAJ—Hi Grade Wireless Inst. Co., Asheville, N. C.
- KDZZ—Kinney Bros. & Sipprell, Everett, Wash.
- WFAG—Radio Engineering Laboratories, Waterford, N. Y.
- WFAP—Brown's Business College, Peoria, Ill.
- WFAT—Daily Argus-Leader, Sioux Falls, S. D.
- WFAR—Hall & Stubbs, Sanford, Me.
- WFAL—Houston, Chronicle Pub. Co., Houston, Texas.
- WFAN—Hutchinson Elect. Service Co., Hutchinson, Minn.
- WFAQ—Missouri Wesleyan College and the Cameron Radio Co., Cameron, Mo.
- WFAB—Pacific Radiofone Co., Inc., Portland, Ore.
- WGAB—QRV Radio Co., Houston, Texas.
- WFAM—Times Publishing Co., St. Cloud, Minn.
- WFAS—United Radio Corporation, Fort Wayne, Ind.

CAN "CANNED MUSIC" WHEN BROADCASTING!

If broadcasting is to continue in its present state of popularity, the entertainment sent out by some stations must improve, an official of the Department of Commerce said today. "Why is it," he asked, "that some broadcasters send out 'canned music,' particularly when the records are not very good and the transmission is poor?"

Today nearly every householder has a phonograph and a set of favorite records, but if he hasn't he can hear "jazz" at almost any shoe-shining parlor. He doesn't want to listen to inferior records.

Except in communities where good talent for vocal or instrumental music is unavailable, there is no excuse for putting on phonograph records and cluttering up the ether, it is pointed out by radio officials.

RADIO ENTERTAINMENT FOR FIREMEN

In order to give firemen the benefits to be derived from the educational features of the broadcasting by radiophone of current events and topics of interest, Fire Commissioner Thomas J. Drennan has given his official sanction to the installation of radio receiving sets in the fire engine houses of the department.

Quite a number of the fire engine houses are equipped now, and have been since the radio became popular, but for some time the presence of the receiving outfits in engine houses has been a matter of divided opinion as to the propriety of such equipment on city owned property without official approval. Commissioner Drennan's order now clears up that complex situation.

In issuing approval for the installation of radio receiving phones, Mr. Drennan points out that it will furnish diversion and healthy recreation for the firemen and help relieve some of the monotony of engine-house life. The receiving sets may be installed at the expense of the firemen themselves, as most of them have to date. But application must be made to the Chief of Department, accompanied by a sketch or plan of the proposed installation.

This will be referred to Val Fendrich, Chief of the Bureau of Fire Alarm Telegraph, for his approval and later for inspection by the Department of Water Supply, Gas and Electricity, which has jurisdiction over all electrical appliances in public buildings.

In his order sanctioning the installation of radio receiving phones, Commissioner Drennan has promulgated a set of prescribed regulations, which were drawn by Chief

GODELL PRATT
1500 GOOD TOOLS

"Small enough to go in your pocket," says Mr. Punch
"but, my, how it drives screws!"



"How many times have you wished for a screw-driver you could carry around with you?" asks Mr. Punch. "This Goodell-Pratt Screw-Driver Set fits conveniently in your pocket. It is just what you need while working on your radio instrument."

The set consists of a hollow handle, with a chuck, three small screw-driver blades, and a reamer. When not in use, the chuck and blades are kept inside the handle. Blades are made of tool steel. The handle is polished, nickel-plated and buffed. It is surprising how often you have an opportunity to use a compact, efficient tool like this.

Special Price, \$1.00

We are offering this Pocket Screw-Driver Set for a limited period at a special price of \$1.00, postpaid to any part of the United States.

Cut out and mail this coupon to us today so that you can take advantage of this reduction. Your order will include our catalog illustrating and pricing all the Goodell-Pratt 1500 Good Tools, among them other tools you'll want for radio work.



GODELL-PRATT COMPANY
Toolsmiths
GREENFIELD, MASS., U.S.A.



GODELL-PRATT COMPANY, Greenfield, Mass.

Enclosed find \$1.00. Please send me your Pocket Screw-Driver Set No. 231 and catalog showing all the Goodell-Pratt 1500 Good Tools.

Name.....
Address.....

Klein's Radio & Electric Supply Co.

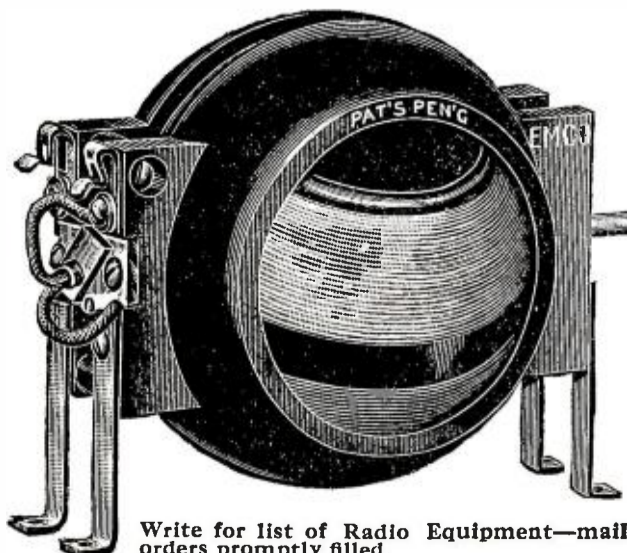

Emco Moulded Variometer

Moulded out of pure bakelite; removable legs for panel mounting. Pig-tail connection, eliminating bearing connection. Price, **\$7.50**

Variable Condenser

- 11 plate \$2.25
- 23 plate 2.75
- 43 plate 3.50



3-Coil Mounting, \$4.50

48 FULTON ST. (near 3d Ave L)
34 PARK PLACE (near Woolworth Bldg.)

NEW YORK

Write for list of Radio Equipment—mail orders promptly filled.



Ray-O-Vac Long Life B-Battery for all types of Radio Sets

Specially built by battery experts for Radio Service. Ray-O-Vac batteries are now ready for delivery.

Fifteen cells are assembled as a solid unit and treated with special insulating compound to eliminate induced current and noises in receiving.

Four sizes: For Stationary Sets with variable voltages from 1½ to 22½ volts; Portable Type with voltage adjustment 18 to 22½ volts; for Airplane Sets, weight only 1 pound, full 22½ volts. Baby B Battery for use in boosting voltage when larger battery has been over-worked.

Write for literature and prices.

FRENCH BATTERY & CARBON CO.

Madison Wisconsin



French RAY-O-LITES and Dry Batteries

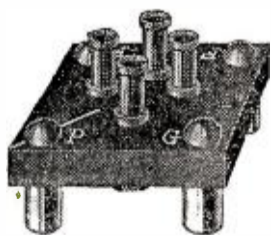

A V. T. socket with many distinct advantages. Greater contact surface, giving better connections that will not work loose. Pins mounted on genuine polished bakelite base, fused to prevent burning out tube.

Fits any standard four-prong tube **\$1.00 ea.**

Variometers, vario-couplers, miniature plugs, phone tip jacks, phone connecting block, grid condensers, grid leaks, variable condensers, etc.

Write for descriptive literature and price lists.

Ozburn Abston Radio Company, Inc.

600-612 Monroe Ave.
MEMPHIS, TENN.

Formerly V. H. LAUGHTER

Fendrich and Assistant Electrical Engineer William F. Hennessy. They are:

Submit sketch or plan of proposed installation.

Give size of wire, where the antenna is made, etc.

All equipment must be within the city owned building lot.

Lightning arrester must be grounded only on city property.

Lightning arrester must have an approved clamp.

Fire house lighting system may be used for recharging battery, but must not be used for other batteries.

Only approved charging devices are to be employed.

All correspondence pertaining to radio must be in writing.

All installations must comply with the code in force by the Department of Water Supply, Gas and Electricity.

No broadcasting or sending sets will be used.

The U. S. Government regulations must be observed and strictly adhered to.

PITTSBURGH TO HAVE "RADIO DAY"

"Radio Day" is the name given by the Radio Engineering Society of Pittsburgh to a day set aside each year for an outing of the radio fans of Pittsburgh and vicinity. The idea originated with the above society when it held the first "Radio Day" in Pittsburgh on August 17, 1919, attended by a small group of radio enthusiasts. The annual radio outing of the society has since been a regular event each year and has met with widespread popular approval. From a small group of "old timers" in the amateur fraternity of this locality who attended the first modest gathering, the attendance at these annual outings of the Radio Engineering Society each succeeding year has grown to such proportions that it was deemed necessary by the Society to arrange for the exclusive use of a large amusement park this season to accommodate the crowds it is confidently expected will turn out for the occasion.

The committee in charge of the affair is composed of the following officers and members of the Radio Engineering Society: W. K. Thomas, chairman; C. E. Urban, secretary; M. Hirsch, treasurer; Dr. Omar T. Cruikshank, Guy Davis, W. E. Menges, John B. Coleman, C. C. Young, John Schaming and Thomas McLean.

Pittsburgh's "Radio Day" will be held August 24, 1922, at Westview Park, which is ideally situated and adapted for the purpose. A program of events is being planned that is literally "chock-full" of novelty, pep and entertainment. Many new and interesting radio contests are being scheduled, with prizes for the winners that will cause a scramble of applicants to participate. The prizes will be donated by the various local radio dealers and manufacturers, who will stage an exhibition of the latest developments in radio appliances covering 300 square feet of space in two large exhibition halls on the grounds. Some of the dealers have started a movement to have all radio stores in the Pittsburgh district close on the day of the outing, and will insert placards in their windows bearing the inscription:

"This Store Will Close August 24th,

'RADIO DAY'

Meet us in Westview Park"

The park is but a short ride from the city and has many amusement features, such as a roller-coaster, dip-the-dips, lake rowing, pony riding, merry-go-round, curiosity house, moving-picture theatre and other attractions. Dancing will take place afternoon and evening at a large dancing pavilion. While a first-class dance orchestra will be provided, it is also planned to dance certain numbers to radiophone music transmitted by local broadcasting stations and received on

"SHRAMCO PRODUCTS"

Amateurs: Send 5c in stamps, today, for our new Catalogue L showing complete line of parts, raw materials and high grade apparatus.

Dealers: Write for our attractive proposition.

THE SHOTTON RADIO MFG. COMPANY, Inc.

8 Market St. Albany, N. Y.

PANELS

Immediate Delivery Cut to Your Order

1/8"02 per sq. inch
3/16"02½ per sq. inch
1/4"03 per sq. inch

Stock Delivery on Formica Tubing

Send a 2c stamp for our latest price list

Special proposition to dealers from "PITTSBURGH'S RADIO SHOP"

PITTSBURGH RADIO AND APPLIANCE CO., Inc.

Desk A

112 Diamond St., PITTSBURGH, PA.

Agents for the

DX RADIO FREQUENCY TRANSFORMER

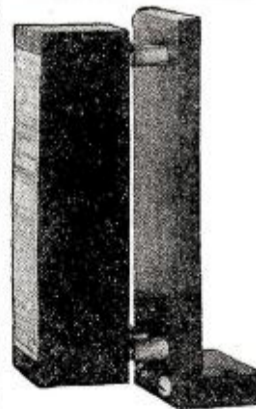

The secret of DX work. Makes coil aerial reception a reality. Its superiority is well established. Prove it for yourself. See p. 930 April-May 1922 issue Radio News.

Range 170-450 meters, \$8.00
" 400-1200 " 8.00
" 900-3000 " 8.00
Plug-in socket mounting 1.00

COLUMBIA RADIO SUPPLY CO.

808 - 19th St., N. W.

Washington, D. C.

RADIO HEAD SET CORDS

R. W. LILLIE CORPORATION

50 Church St.
NEW YORK CITY

176 Federal St.
BOSTON, MASS.

apparatus equipped with multi-stage amplifiers and loud-speakers.

Meals will be provided, table d'hôte or à la carte, at popular prices, in the Park dining room, which is spacious and well equipped. However, there is also a picnic grove for those desiring to bring basket lunches.

Considering the great popularity of radio in this locality, not a small part of which is due to radiophone broadcasting, and the fact that several powerful stations are located in and around Pittsburgh, coupled with the success of the former radio outings, it is anticipated that the coming event will be a tremendous success in every way.

CONGRESSMAN WHITE'S RADIO BILL—ALL AMERICAN! ADVISORY COMMITTEE OF TWELVE APPROVED—AMATEURS GET 150 TO 275 METERS

The "Radio Bill," amending the act to regulate radio communication of 1912, was introduced in the House of Representatives by Congressman White of Maine.

It follows the recommendations of the Hoover Radio Committee, authorizing the appointment of an advisory committee of 12 Government and civil radio experts, it provides for licenses for transmitting stations and operators and their revocation, regulates fees, protects national interests in time of war, prohibits operation by aliens or foreign companies and authorizes the Secretary of Commerce to classify licensed stations and assign wave bands, as well as make, alter and revoke regulations.

The amateur is not forgotten, as his wave band is extended from the single 200 wave to a band from 150 to 275 meters. Monopoly is avoided, the Secretary being authorized to refuse a license to any person or corporation which appears to be monopolizing radio communication through the control of manufacture or sale of radio apparatus.

The first draft of the pending bill was submitted to the conference, which approved it generally but recommended a number of minor changes now incorporated. The legal drafting committee was composed of Mr. White, chairman; Senator Kellogg, Mr. Tyrer, Deputy Commissioner of Navigation of the Department of Commerce, and Mr. Terrell, in charge of the Radio Division of the Department of Commerce.

MR. WHITE EXPLAINS HIS BILL

Mr. White explained that "the bill presented is not a comprehensive radio law. It leaves the Act to regulate Radio Communication, approved August 13, 1912, as the basic law upon this subject. It amends that law only so far as is deemed necessary to make possible the carrying out of the approved recommendations of the conference. Since 1912 the use of radio has grown enormously, and wireless telephony was then practically unknown. Today the transmitting sets for telegraphy and telephony and receiving sets of both kinds number hundreds of thousands. Telephone broadcasting and the other uses to which the art has been put and the great number of users of transmitting sets have brought about a congestion in the air seriously interfering with the efficient use of the ether by any interest, for any character of service. * * *

"The radio art changes over night. It is neither standardized nor stable. There is today no like activity attracting the attention of so many technical and scientific men as this. Improvements in old methods and instruments and radical departures from accepted standards come with every passing day. The members of the conference recognized fully that the recommendations so laboriously worked out by its Technical Committee might be out of date, demanding drastic revision in a month's time. In these facts is found the compelling reason for

ERLA RADIO Equipment

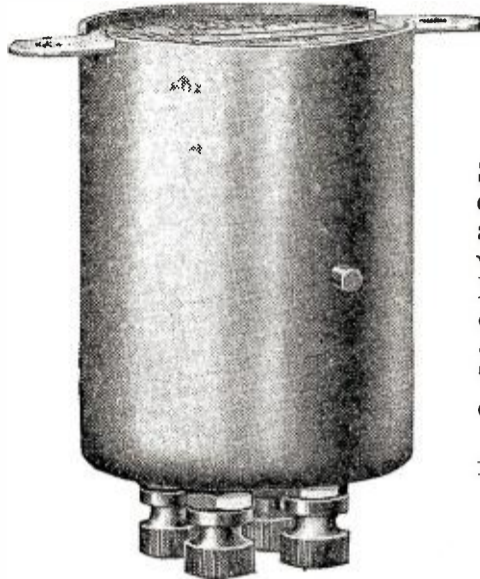

Radio Frequency Transformer

Signals from a great distance not strong enough to be detected with audio frequency amplification can be picked up and heard with perfect clearness with the Erla Radio Frequency Transformer. Greatly increases efficiency and enjoyment of any set. No complicated tuning—simple, easy to handle. Tube noises, distortion and static interference greatly reduced. Designed to fit a V. T. Socket or be vertically mounted. Beautifully finished. List, \$6.00 each.

V. T. Socket

A sturdy, dependable socket of absolutely the finest quality and highest efficiency.

Adapted to any standard American four-prong transmitting or receiving tubes. The rugged contact spring will not arc under the filament current of five-watt transmitting tubes. Very easily wired and unwired. Great care has been taken to insure against leakage. Highly nicked brass shell. Highly polished black Radion base. List, \$1.00 each.

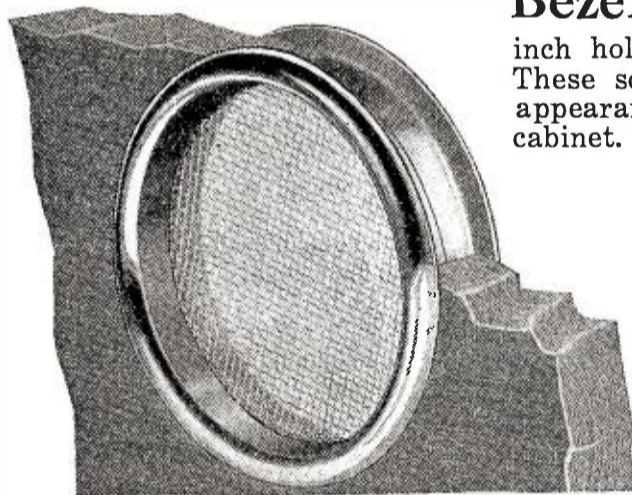
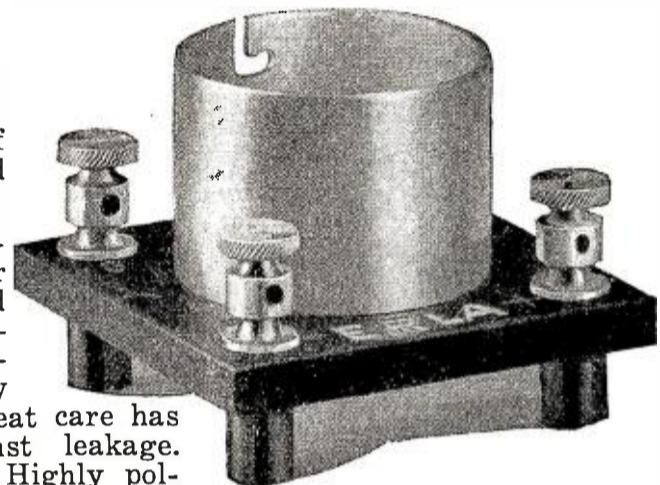

Bezels 1½ inch diameter of highly nicked brass. Will fit 1½-inch holes in any ¼ to ½-inch panel. These screened bezels add 100% to the appearance of the panel of any radio cabinet. List, 20c each.

We also make Vario Couplers, Variable Grid Leaks, Grid Condensers and other equipment—all of the finest materials and most advanced design—all made by experts.

We are making immediate deliveries to jobbers and manufacturers. Write or wire for details of our attractive proposition.

The Electrical Research Laboratories

General Offices: 2515 South Michigan Avenue, Chicago, Ill.



Vitalitone LOUD SPEAKERS

ON THE MARKET THREE YEARS

NEW MODEL, \$40

MOST BEAUTIFUL APPEARANCE, HIGHEST EFFICIENCY, SENSITIVE, NO DISTORTION

FULLY GUARANTEED, WITHOUT RESERVE

Immediate Delivery

MANUFACTURED BY

VITALIS HIMMER

205 SIXTH AVE.

NEW YORK

The material contained costs thousands of dollars to assemble. You can get a copy of bound volume No. 2 of Radio News for only \$2.50 plus postage. Experimenter Publishing Company, Inc., 53 Park Place, New York City

RHAMSTINE* RHEOSTAT



\$1.75

Postage 6c

THE Rhamstine* Rheostat conveys instant and vivid conviction of value. It is a new Rhamstine* Product and aside from its original design and attractive appearance, it possesses these valuable features:

1. Compactness—the element ring is only 1 1/4 in. in diameter.
2. One hole for mounting—the bearing for the shaft also holds the rheostat frame.
3. Brush Contact—two stationary brushes make contact with the resistance element.
4. Air cooled.
5. Noiseless.

It is exceptionally well made, dependable and durable and quite advanced in design.

Ask your dealer to show you how it works.

Circulars Upon Request

MANUFACTURED BY

J. THOS RHAMSTINE*

2152 E. Larned St. Detroit, Mich.

*Manufacturer of Radio Products

RADIO

Equipment

**Big
FREE
Catalogue**



THIS FREE catalogue tells you the kind of a Wireless Telephone to own, so that you receive in your own home all the latest news, music, church services, lectures—everything broadcasted throughout the United States. Every home will soon have a wireless telephone outfit. We now offer complete outfits from \$15 up.

Everyone interested in radio should see our low prices on parts and accessories. Write for this book. Learn about the miracle invention of the age. Easy to install, as simple to operate as a regular telephone.

One copy of this booklet is yours, free. Write for your copy.

Address Dept. R-2

Montgomery Ward & Co.

KANSAS CITY CHICAGO ST. PAUL

RADIO

Prices on Dials, Switch Levers, Variometers, Variocouplers and Receiving Sets will interest you. Send for price list.
GENERAL RADIO SUPPLY CO.
5056 Broadway CHICAGO 117 N. Dearborn St.

drafting the proposed legislation in most general terms. Statute law cannot be speedily changed. It is vital that the provisions of the law and of the regulations thereunder be so framed that the regulations may be changed as the art itself changes. Of necessity there is no way of meeting this unprecedented situation except by conferring in general terms broad powers of supervision, of regulation and of control upon the designated regulatory body. We have conferred upon the Secretary of Commerce, designated by the basic law of 1912 as the agency of the Government for the control of this means of communication, the powers required in the premises."

A BRIEF REVIEW

In addition to granting enlarged powers of regulation, the bill undertakes to clarify certain ambiguities in the present law, and adds to existing law a number of sections of minor consequence.

One section asserts Federal control over radio communication between the several states and with foreign countries, and requires that no such interstate or foreign communication shall be carried on except under and in accordance with a license granted by the Secretary of Commerce.

The Secretary is authorized to classify licensed radio stations, to prescribe the nature of the service to be rendered by each class of stations, to assign bands of wave lengths, to make regulations concerning the location of licensed stations, the kinds of instruments to be used in them with respect to the external effects of the instruments, the time and methods of operating transmitting stations, and generally is given authority to make any regulations consistent with law deemed necessary to prevent interference. Receiving sets and operators are not affected.

The relation of the many stations owned by the various departments of the Government to private and commercial stations has presented a perplexing question.

OFFICIAL MESSAGES EXCEPTED

The bill provides that radio stations belonging to and operated by the United States and used exclusively for official business are not subject to the general regulations, but it provides that the wave lengths which Government stations use shall be allocated to them by the President, because the President is more likely to properly appraise the legitimate needs of military and naval stations than are the military and naval authorities themselves. The band between 600 and 1,600 meters is no longer exclusive to army and navy. It is further provided that such Government stations must observe regulations aimed to prevent undue interference as the Secretary of Commerce may prescribe, and that the President at any time may suspend such regulations.

The conference believed that "Government stations used for other than strictly Governmental business, that is, stations broadcasting jazz and speeches and other matter not official in character, should be subjected, in the interests of efficient communication for all, to the same regulation and control as private stations."

The President in time of war or of public peril or disaster is authorized to cause the closing of any radio station or to authorize the use and control of any such station by any department of the Government.

That licenses for stations shall not be issued to aliens or to alien interests is provided for. The existing law does not guard against a license being issued to a citizen who may be the representative of a foreign government or of a foreign company or to a company of foreign ownership or control organized in the United States.

ANTI-TRUST PROVISIONS

"There has been a somewhat prevalent belief, and there was some evidence to justify

HOMMEL

Radio Equipment Service for the Dealer

How much of an investment must I be prepared to make?

How much of this, that, and other things should I carry?

These are the most vital of the many questions which the prospective dealer must answer.

We can help to answer them, because we have a Dealer Service Department which is devoted to the study of markets, turn-over, the proper selection of radio equipment and other subjects that concern the dealer.

Furthermore, we are distributors for more than 40 of the most prominent manufacturers, and are usually in position to supply most of the dealer's needs from our large stocks.

Write us about your problems—our service will not obligate you in any way.

Catalog No. 100S sent upon request. Wholesale only.

DISTRIBUTORS FOR



Radio Corporation of America (Westinghouse and General Electric), Murdock, Fada, Remler, Frost, Brandes, Pacent, General Radio, Radio Service, De Forest, Baldwin, Signal, Acme, Rhamstine, Kellogg, Holtzer-Cabot, Connecticut, Burgess, Hipco, Homcharger, Brach, Chelsea, Arkay, Clapp-Eastham, and other leading manufacturers.

LUDWIG HOMMEL & CO.
530-534 FERNANDO ST. PITTSBURGH, PENNA.

Armco Ingot Iron for Electrical Uses

in Cold Rolled Strips and Bright Drawn Shapes and Bars

Silicon Electrical Sheets for Radio

Transformers, Condensers, etc.

Ward's Permanent Magnet Steel

for Highest Quality Magnets

EDGAR T. WARD'S SONS CO.

Boston, Brooklyn, Newark, Philadelphia, Cleveland, Detroit, Chicago

T-B-H HEAD SETS

\$8.00 List 2,000 Ohms

8000 Turns Per Receiver

A Quality Product

"Use 'em 10 days—if you don't like 'em send 'em back and get your money."

Write for Circular 6-A

TELEPHONE BOOK HOLDER CORP.

Dansville, New York

BALDWIN PHONES

made into LOUD speakers. I will supply Horn and Box, price reasonable. BALDWIN PHONES repaired, adjusted, tuned and new diaphragms put on. Wireless receiving sets built to order, repaired, etc.

Established 1910

J. F. ARNOLD, 109 E. 125th St., N. Y.

the opinion offered to the conference, that certain large manufacturers of radio apparatus, through the ownership of essential patents and through contracts with selling agencies and by other means, were unduly restricting the manufacture and sale of desirable apparatus," Mr. White says. "In view of this situation the bill specifically authorizes the Secretary to refuse a license to any person or corporation which in his judgment was monopolizing or seeking to monopolize radio communication through the control of the manufacture or sale of radio apparatus."

LICENSES REVOCABLE

There was complete concurrence in the conference that the issuing of licenses should be discretionary. Today the practice is to issue licenses for one year, but there is nothing in the law to prevent the issuance of a license for 50 years or practically in perpetuity. It is now proposed to limit the life of a license to 10 years, with a privilege of renewal.

The Secretary is authorized to prescribe the form of the licenses and require that all licenses shall contain, in addition to other provisions approved by the Secretary, a statement of the condition that the ownership or management of the licensed station shall not be transferred in violation of this act, and that there shall be no vested property right in the license or in the bands of wave length authorized to be used.

Provision for the revocation of licenses under certain conditions is made.

The construction of a station for which a license is required shall not be begun until a permit is obtained.

ADVISORY COMMITTEE

A new proposal authorizes the establishment of an advisory committee of 12 to which the Secretary of Commerce may refer for examination and report various matters relating to the administration of radio laws, regulations and treaties, and to the scientific problems involved in radio communication. The recommendations of this committee are purely advisory, but it is felt that such a committee will tend to bring harmony of view between the various departments of the Government interested in radio and between Governmental users and the private interests. The personnel of the committee will include representatives of the State, War, Navy, Agricultural, Post Office and Commerce Departments and six civil communication authorities to be designated by the Secretary of Commerce.

In the interests of safety at sea, the bill requires that radio telephone stations, the signals of which can interfere with ship communication, shall keep a licensed operator listening in on the wave length designated for distress signals, during the entire time the transmitter of such telephone station is in operation.

The law in effect gives to the amateur of the country a 200-meter wave length, but the conference recommendation that there should be allocated to the amateur a band of wave lengths between 150 meters and 275 meters has been authorized.

A schedule of fees running from second-grade amateurs' license at 50 cents to commercial first-class operators at \$2.50 and from \$2.50 for an amateur station to \$300 for a transoceanic station is provided, from which it is expected the cost of administration can be met.

NAVY TUBES SOLD

The Navy has sold its 30,000 surplus radio transmitting tubes to Bachrack Brothers of New York at \$2.51 each. The successful purchaser was not the high bidder, but due to the elimination of some bids which did not comply with technicalities, this company secured the award.

safe radio

Protect Your Family, Your Home and Your Radio Instrument From Lightning—Reduce the Static in the air that mars your signals and get good, clear music and vocal tones.

All this is accomplished by the installation of the



This is the arrester that is listed by the National Underwriters' Laboratories

It is the arrester that is insisted upon by both the skilled engineer and the little amateur.

It is the arrester that is foolproof, takes care of itself, works automatically, requires no switching on and off.

Why take chances with any other when you can get the Brach Vacuum Arrester that has long been recognized by the United States Army, by the big railroad and telegraph companies, by fire departments—and, finally, is approved by the National Underwriters' Laboratories.

Your Dealer
Will
Supply You

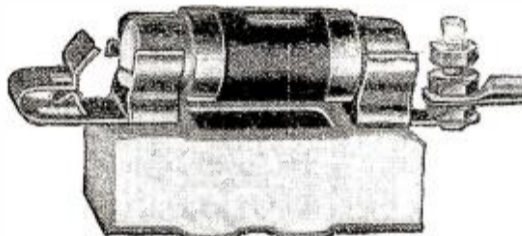

Distributed
by
Leading Jobbers

Indoor Type.....\$2.50
Outdoor Type..... 3.00

L. S. BRACH MFG. CO.
NEWARK, N. J.

Sixteen Years Specialists in Lightning Protective Apparatus

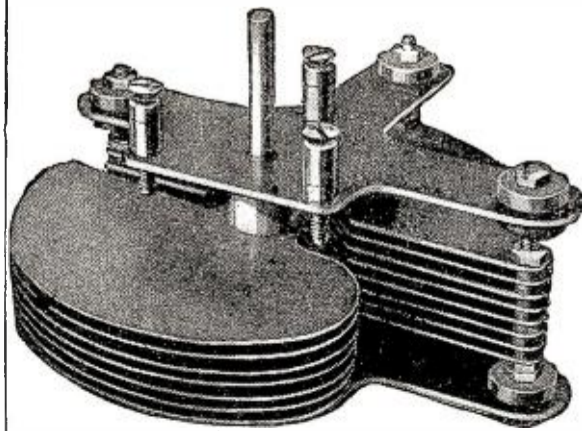

SPECIAL PRICE REDUCTION

The Gotham Variable Condenser

Capacity .0005 mfd \$3.75—.001 mfd \$4.75

Plates designed so as to give an even change of capacity over entire range. Very low minimum capacity. Complete Sets and Parts to make your Own Sets.

WRITE FOR CATALOG

DAVID KILLOCH CO.
57 Murray Street NEW YORK CITY

MONEY FOR YOU—Add to your salary—Make extra pin money—Start a lucrative business of your own. Spend an hour each day taking subscriptions for the Radio News. We'll pay you well and you'll enjoy the work. Write for full particulars. Circulation Dept., Radio News, 53 Park Place, New York City.

We Save You Money on RADIO CABINETS

Assemble your set in one of these handsome cabinets equal in appearance to the most expensive, yet priced unbelievably low. Everyone can afford them. A necessary protection against dirt, dust and atmosphere. Made of selected Oak, splined cover, will not warp; shipped knocked down, with full instructions for easy assembling and staining. Order today, cash or money order.

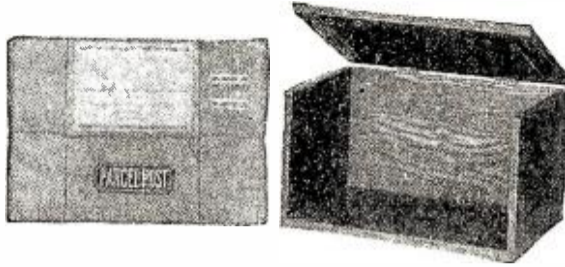

Panel Size	Price	Panel Size	Price
6x7"	\$1.50	9x14"	\$2.75
6x10 1/2"	2.00	12x14"	3.25
6x14"	2.00	12x21"	3.65
6x21"	2.50		

All Cabinets 7 inches deep inside



VARIABLE CONDENSERS

Exceptionally efficient. Very compact. .061 Spacers. Aluminum plates, brass optional. Additional plates upon application.

43 PLATES, .001 Assembled \$5.25
23 PLATES, .0005 Assembled \$4.35

RADIO SET

\$395

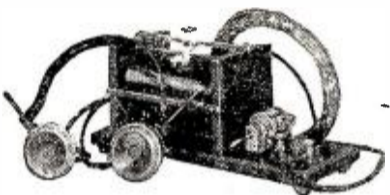

Parcel Post Order Today

Equal to sets at several times the price. Dust-proof Detector, Insulated Sliders. Coil wound, parts machined and finished. Neat. Shipped knock down with instructions for easy assembling. Aerial wire included.

Above Set With Double Phones \$9.65

Above described Receiving Set with Double Head Phones, complete, ready to listen in.

Double Head Phones, Separately \$5.75

Radio Cabinet Co. of 1460 Hubbard Ave. Detroit, Mich.



PANELS

DISCS
COIL HEADS

End Plates for Variable Condensers
Strips for Fixed Condensers
Special Shapes for All Purposes

J. SPAULDING & SONS CO., INC.

NEW YORK.....484 Broome Street
BOSTON.....15 Elkins Street
PHILADELPHIA.....141 North 4th Street
CHICAGO.....659 W. Lake Street
TONAWANDA.....New York

A FULL PAGE

would not be large enough for us to list all our apparatus, so all we can say is to get in touch with us for your radio apparatus.

BECAUSE

we can save you considerable money. Our prices are far below list prices on all standard makes of radio apparatus.

If you can't call, write—our mail order department gives prompt and efficient service.

SOLAR RADIO CORPORATION

532 Nostrand Avenue
879 Flatbush Avenue
BROOKLYN, Dept. R, NEW YORK

WASHINGTON BAND WILL PLAY FOR THE WHOLE COUNTRY

Generosity coupled with radio has led the Nation's Capital to share its music with the country at large. Plans are under way for broadcasting summer band concerts held practically daily in the parks of Washington. Through the cooperation of the Department of Public Buildings and Grounds, the Naval Communications Service and the Signal Corps, transmitting microphones will soon be erected in the handstands at the White House and Potomac Park and connected by wires with the Naval Radio Station at Anacostia, so that when there are band concerts by the Marine and other bands they can be broadcasted for the benefit of radio enthusiasts within 800 miles from Washington. Later on more transmitters, probably portable ones, will be provided for other parks and circles where band concerts are held, and as there is a concert every evening the air will soon be full of music emanating from here.

It is rumored that Signal Corps radio trucks may be stationed in out-of-the-way sections of the city to provide a means of listening in for those who are so unfortunate as not to possess receiving sets. The Naval Station at Anacostia will broadcast on 410 or 412 meters, it is understood, between 7 and 8 p. m., but it is not yet known when the broadcasting will start.

NEW BROADCASTERS

STATIONS LICENSED DURING WEEK ENDING JUNE 10

WFAA—S. H. Belo & Co., Dallas Morning News, Dallas, Texas.

WEAX—T. J. M. Daly (Argenta), Little Rock, Ark.

WEAY—Will Horwitz, Jr., Houston, Texas.

WEAZ—Donald Redmond, Waterloo, Iowa.

WEAN—Shepard Company, Providence, R. I.

KDYL—Telegram Publishing Co., Salt Lake City, Utah.

WFAB—Carl Frank Woese, Syracuse, N. Y.

WEAR—Baltimore American & News Pub. Co., Baltimore, Md.

WEAU—Davidson Bros. Co., Sioux City, Iowa.

WEAT—John J. Fogarty, Tampa, Fla.

WEAS—Hecht Company, Washington, D. C.

WEAP—Mobile Radio Co., Inc., Mobile, Ala.

WEAO—Ohio State University, Columbus, Ohio.

WEAV—Sheridan Elec. Service Co., Rushville, Neb.

KDZU—Western Radio Corp., Denver, Colo.

WEAQ—Y. M. C. A., Berlin, N. H.

CHANGES IN SERVICE OF OLD STATIONS

WGI—Amer. Radio & Research Corp., Medford, Hillside, Mass., now carries entertainment and markets.

WCAP—Central Radio Service, Decatur, Ill., now carries entertainment and weather.

Navy Broadcast for Amateurs During the Month of May, 1922

2d—English—Where aerial lead in wire passes through walls or sides of building the Underwriter rules provide that a non-combustible bushing insulator shall be used period A porcelain tube or bulkhead bushing insulator may be used for this purpose.

3d—English—New rules made by National Fire Underwriters provide that an approved lightning arrester which would operate at potentials over five hundred volts shall be connected with the aerial lead in wire and to the ground before the lead in wire is connected to the receiving set. This is required whether you have a lightning switch or not period A lightning switch is not required in addition to the lightning arrester but may be used.

Dials that lend Distinction



A Real Set and Loud Speaker

Join Our Buyers' Service Club

Complete Line of Parts

Aero Mfg. Co.

142 Market St. Newark, N. J. Dept. R.

The "Q. S. A." Line of Radio Equipment

Are you being handed the inferior radio equipment now flooding the market? Long before the present boom "Q. S. A." equipment was well known to the amateur trade. Ask anyone of the old time amateurs and he'll tell you. Your only guarantee against inferior goods is to order from the "Q. S. A." catalog which will be sent for 10 cents in stamps or free with order from this ad. Below are some items not shown in our catalog but on which we can give you the same prompt service.

Fixed Receiving Condenser .001 mfd.....	\$.70
Vacuum Tube Socket, composition.....	.75
3-inch Bakelite Dial and Knob.....	.85
Sw. Lever Set, consisting of 1 Sw. Lever, 14 contact points, 2 Sw. Stops, and 2 Binding Posts—a very good buy at only.....	1.00
Stay-Hot Soldering Iron, burns alcohol.....	2.00
Grewal "always adjusted" crystal detector.....	2.00
Howard Filament Rheostats.....	1.10
Brach Lightning Arrester.....	2.50
11 Plate Variable Condenser.....	3.30
23 Plate Variable Condenser.....	4.25
Federal Jr. Crystal Set, Complete with Phones	25.00

INDEPENDENT RADIO SUPPLY CO.

3239 Ogden Avenue CHICAGO, ILL.
"A Radio Store with a Conscience"

Complete Line RADIO SETS and PARTS

Prompt Shipments

DEALERS

Write for Price Schedule

TIMES APPLIANCE CO., INC.

145 West 45th Street
NEW YORK

JOBBERS: Radio Corp. of America and Others

RADIO FREE CATALOG

Illustrating complete sets, Westinghouse, Grebe, Remler and other standard makes. Parts to make your own set, Antenna wire, Head sets, latest books. Sixty-two years in business.

JULIUS ANDRAE & SONS CO.
117 Michigan St. Milwaukee, Wis.

4th—English—Following radio telephone stations assigned call letters WAAV Athens Radio Co Athens Ohio WAAW Omaha Grain Exchange Omaha Neb WAAX Radio Service Corpn Crafton Pa WAAV Yahrling Raynor Piano Co Youngstown Ohio WBAB Andrew J Potter Syracuse NY WRQ Radio Corpn of America Marine Mass WBAC Kiwanis Club Des Moines Iowa WBAD Sterling Electric and Journal Printing Co Minneapolis Minn WBAE Bradley Polytechnic Institute Peoria Ill WBAF Fred M Middleton Moorestown NJ WBAG Diamond State Fibre Co Bridgeport Pa WBAH Dayton Co Minneapolis Minn WBAJ Marshall Gerken Co Toledo Ohio WBAK Pennsylvania State Police Harrisburg Pa WBAL US Shipping Board Savannah Ga WBAM I B Renny Son New Orleans La.

5th—English—Following Radio Telephone Broadcasting Stations have been assigned call letters: WBAN, Wireless Phone Corporation, Paterson, N. J.; WBAO, James Miliken University, Decatur, Ill.; KSC, O. A. Hale & Co., San Jose, Cal.; KUY, Coast Radio Co., El Monte, Cal.; KNN Bullocks Los Angeles Cal KYF Thearle Music Co San Diego Cal KNT North Coast Products Co Aberdeen Wash WBAP Wortham Carter Publishing Co Fort Worth Tex WBAQ Myron L Harmon South Bend Ind WBAU Republican Publishing Co Hamilton Ohio WBAV Erner and Hopkins Co Columbus Ohio WBAW Marietta College Marietta Ohio KNI T W Smith Eureka Cal WBAX John H Stenger Wilkes Barre Pa KOJ University of Nevada Reno Nev WBAY American Tel and Tel Co New York NY WBAZ Richmond Times Dispatch Richmond Va

6th—English—The following call letters have been assigned to special land stations One XC Ellsworth Me One XG Bangor Me Two XM New York two XY New York four XA Atlantic a Ga five XF Brownwood Tex five XM New Orleans La five XN Houston Tex five XO Knoxville Tenn five XX Austin Tex five YR New Orleans La five YS Fort Worth Tex five YT San Marcos Tex five ZAQ Dallas Tex five ZAR El Paso Tex five XX ZH Amarillo Tex six XI Pasadena Cal Six ZQ Berkeley Cal six ZS Bakersfield Cal seven XI Portland Ore seven YI Polytechnic Mont eight XG Washington Pa eight YJ Columbus Ohio eight XM Lansing Mich

6th—Eight ZM Buffalo NY eight ZO Columbus O nine XB Chicago Ill nine XC Colorado Springs Colo nine YF Mayville N Dak nine ZG Mount Carroll Ill

7th—Signal Corps has recently published two pamphlets one entitled Signal Corps Radio Communication Pamphlet number one treating of elementary principles of radio telegraphy and telephony in a manner easily understood by the amateur cost ten cents period and Signal Corps Training Pamphlet number one treating of elementary electricity magnetism storage batteries and dynamos cost fifteen cents period They may be obtained from the Superintendent of Documents Government Printing Office Washington D C (English)

8th—This Bureau recommends that a lightning switch be used in addition to the lightning arrester required by the new fire underwriter rules The lightning arrester may be connected between the blade and ground connections of the lightning switch period the same ground connection may be used for both methods of protection period (English)

9th—Three hundred sixty meters and four eighty five meters are now authorized as radio-phone broadcasting wave lengths by the Secretary of Commerce period The three hundred sixty meter wavelength to be used for broadcasting important news items entertainments lectures sermons and similar matter period The four hundred eighty five meter wavelength to be used for broadcasting Government reports such as crops and market estimates and weather forecasts period operators of such stations must hold second class license or higher (English)

10th—Code two—Following received from National Headquarters Boy Scouts of America quote to every boy scout who comes within the sound of this message and his brother scouts stop are you fully aware of the amateur radio contest that is to be held May twenty second in connection with the International Radio Show at New York the National Council of the Boy Scouts of America wants a scout to win this contest against the whole field of amateurs stop who is going to be that scout stop for entry blanks and further particulars apply at Radio Show headquarters McAlpin Hotel New York City signed James E West Scout Executive unquote

11th—Code four—Following received from National Headquarters Boy Scouts of America quote to every boy scout who comes within the sound of this message and his brother scouts stop are you fully aware of the amateur radio contest that is to be held May twenty second in connection with the International Radio Show at New York the National Council of the Boy Scouts of America wants a scout to win this contest against the whole field of amateurs stop who is going to be that scout stop for entry blanks and further particulars apply at Radio Show Headquarters McAlpin Hotel New York City signed James E West Scout Executive unquote

12th—English—The States included in the radio inspection districts are as follows seventh district headquarters two three zero one L C Smith Building Seattle Washington includes Oregon Washington Alaska Idaho Montana Wyoming eighth district Federal building Detroit Michigan includes western part of New York State and Pennsylvania West Virginia Ohio Michigan lower peninsula ninth district Federal Building Chicago Ill includes Indiana Illinois Wisconsin Kansas Colorado Iowa Nebraska South Dakota North Dakota and upper peninsula of Michigan.

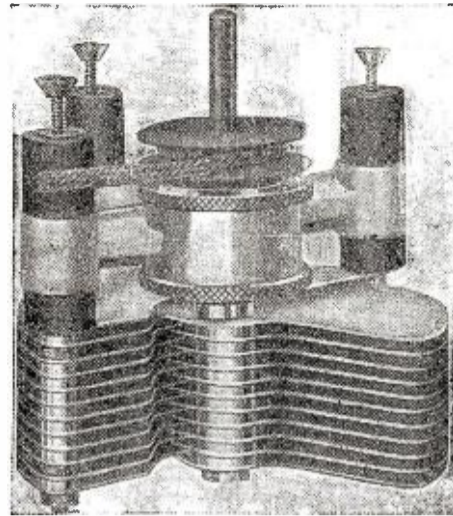

A Better Variable Air Condenser because it is made Better

The time has passed when any condenser would suit you. You must have sharp tuning. You must have a condenser that will work smoothly and be easy of control now, and years from now. COTOCO Condensers have established a reputation for low electrical losses and precise mechanical construction. The best way to be sure to get best results is to

Buy Your Radio Supplies
by the Name



TRADE MARK REG. U. S. PAT. OFF.

This name means RELIABILITY — means built to the specifications of Radio Specialists—means better results for you.

If your dealer cannot supply you, send us his name and we will take care of you.

Our Other Specialties:
Amplifying Transformers
for Audio Frequency
for Radio Frequency
Honeycomb Coils

WRITE FOR BOOKLETS

COTO-COIL CO.
87 Williard Ave. Providence, R. I.



NOVO "B" BATTERIES

FOR WIRELESS SETS



Noiseless—Dependable—Guaranteed
Standard Sizes, 22½, 45 and 105 Volts
Plain and Variable

Packed in Individual Containers

Send for Catalogue and Discounts

NOVO MFG. CO.

424 W. 33d St., NEW YORK—531 So. Dearborn St., CHICAGO



Equipment Specialties RTS Switch Lever

The attention of jobbers and dealers is especially called to the RTS Bushing Lever made to retail at 60



cents. It has many improved features. The knob is of the well known Marconi type, 1 3/4 inches in diameter. The spring lever of nickel bronze has ground ends, insuring smooth and positive adjustment. It has a 3/4-inch bushing and locknut for panel assembly. A guide bushing under the knob is an important feature as it raises the lever to the proper height for all switch points.

Announcing the New RTS Grid Condenser

The new RTS Grid Condenser is now ready for delivery. Contains many improvements not found in other types. Capacity .0005 M. F., price to retail at only.....30c each.

RTS Phone Condenser

RTS Condensers need little description. Their accuracy and simplicity have made them universally popular. The RTS phone condensers, capacity .0013 M.F., complete with binding posts ready for connection, to retail at.....35c each.

RTS Grid Condenser and Grid Leak—

Combined. Made for those who desire the best. Price each45c

RTS Rubber Binding Posts

These posts are as good as any you can find. Bushing heavily nickel plated. Give the amateurs' instruments the appearance of a first class outfit. 12c each or \$1.25 a dozen.

Discounts to Dealers

Dealers and jobbers: Write us today for special quotations and discounts on all RTS equipment.

RADIO TESTING STATION

DEPT. R-7, 25 STURGIS ST.
BINGHAMTON, NEW YORK

Men With Radios Wanted



to introduce and take orders for our **NEW PROCESS STORAGE BATTERY**. Plates cannot sulphate or buckle. No expert attention required.

One-half cup water every 3 months. Made for autos, radios, lighting outfits and all other battery purposes.

Guaranteed 2 Years

The biggest money maker and greatest business builder ever known. Write today for our exclusive proposition and low wholesale prices.

HARSHA BATTERY CO. Dept. 28
19 East Van Buren St. CHICAGO

Standard Underwoods

5-Year Guarantee

Yes, this genuine Standard Visible Writing Underwood newly rebuilt, at much less than factory price, yours for \$3.00 down and then easy monthly payments.

\$3.00 DOWN
10 Days' FREE Trial
Try it for 10 days at our risk. Money back guarantee. Send now for free book. Big bargain offer.
TYPEWRITER EMPORIUM C-195 Shipman Building
SHIPMAN-WARD MFG. CO. Chicago, Illinois



13th—Code six—The radio communication laws require that no person be examined for radio operating license more often than once in three months period that is operator shall not apply for examination for license within three months after qualifying or failing to qualify at an examination period any license held by an operator may be revoked if he fails to comply with this law

14th—All amateurs should subscribe for the radio service bulletin a monthly publication which gives up to date lists of new commercial land ship and special land and government radio stations period also complete list of radio telephone stations which broadcast market and weather reports concerts lectures and so forth this publication may be obtained from superintendent of documents Washington D C for five cents per copy or twenty-five cents per year

15th—Code Two—As soon as they are purchased storage batteries should be charged until no increase is noted in the specific gravity reading for one hour period this reading of the specific gravity may be taken as the maximum specific gravity of the battery at full charge period under normal conditions the battery should be charged to within five points at least of the maximum specific gravity and should be charged at least once a month until the specific gravity fails to increase for a period of one hour

16th—Code Eight—The wire leading from lightning arrester to ground should be as short as practicable but need not be larger than number fourteen B and S gauge copper wire this provision is made by new rules of National Board of Fire Underwriters and applies to receiving stations only

17th—Caution should be taken that storage batteries are not short circuited period when short circuit occurs the battery gives off great volumes of chlorine gas which will explode when brought in contact with flame of electric arc (Code Two)

18th—English—New fire underwriters rules authorize using water main pipes on radiators which are connected to the water pipes for both the ground connection from receiving set and from the lightning arrester period in no case shall pipe connected to gas mains be used for the ground connection

19th—Code Four—Amateurs desiring to operate their own transmitters must first get a special comma general or restricted license as may be desired for their station and in addition must qualify and obtain a second or first grade amateur operators license

20th—Code Ten—Characteristics of the radio apparatus or service of a licensed station must not be changed without the authority of the secretary of commerce

21st—English—The following qualifications are required for amateur first grade license period the applicant must have a sufficient knowledge of the adjustment and operation of the apparatus which he wishes to operate and of the regulations of the international convention and acts of Congress insofar as they relate to interference with other radio communication and impose certain duties on all grades of operators period the applicant must be able to transmit and receive in continental Morse at a speed sufficient to enable him to recognize distress calls or the official keep out signal a speed of at least ten words per minute five letters to the word must be obtained

22d—English—Following is list of new broadcasting stations WCAB Newburgh News Printing and Publishing Company Newburgh N Y WCAC John Fink Jewelry Co Fort Smith Ark WCAD St Lawrence University Canton NY KLXK Tribune Publishing Co Oakland Cal KYI Alfred Harrell Bakersfield Cal WCAE Kaufman and Baer Co Pittsburgh Pa WCX Detroit Free Press Detroit Mich KNX Electric Lighting Supply Co Los Angeles Cal KOI University of California Berkeley Cal WCAG Daily States Publishing Co New Orleans La WCAH Entrecken Electric Co Columbus Ohio WCAT (WCAI) American Legion dash F E Samuel Stat Hqs temporary dash Topeka Kans WCAJ Nebraskan Wesleyan University University Place Nebraska WCAK Alfred F Daniel Houston Texas WCAL St Olaf College Northfield Minn WCAM Villanova College Villanova Pa WCAO Sanders and Stayman Co Baltimore Md

23d—English—All amateurs should endeavor to visit radio show being held at seventy first regiment armory thirty fourth street and Park avenue New York City period opened Monday May twenty second and will close Saturday May twenty seventh at eleven PM period show is open from

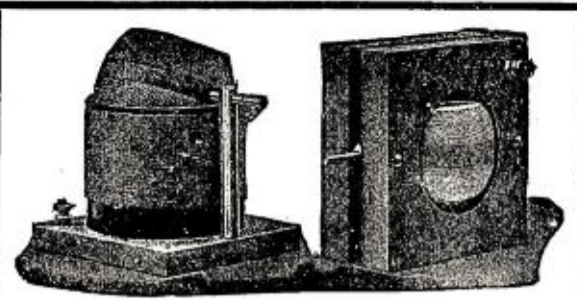

Variometers } \$3.00
Variocouplers } each
Variotuners \$5.50

Wave Length 150-1600 Meters

Completely Assembled
and Guaranteed

SEND FOR BULLETIN

FREDERICK WINKLER, Jr.
304 Columbus Ave., New York, N. Y.

FREE Actual Reports of Secret Service Operator 38

More fascinating than detective stories. Confidential reports of a real operator—No. 38—to his Secret Service Bureau. Absolutely free. No obligations. See how the modern detective works. Read these inside stories of great mysteries. See what possibilities this most fascinating and eventful of all professions offers to you.

Be a Finger Print Expert

To command the highest fees, the Secret Service man must also be a Finger Print Expert. This profession may be easily learned at home, in your spare time. Wonderful opportunity in this UNCROWDED PROFITABLE field.

Big Money The unfilled demand for trained Finger Print men is increasing daily. Opportunity is waiting for you. No time to lose. Send today for these Reports, also our big Free book on Finger Prints. Special offer if you act now!

UNIVERSITY OF APPLIED SCIENCE
1920 Sunnyside Ave., Dept. C-594, Chicago, Ill.

RAY-DI-CO

Radio Supplies for Service and Satisfaction
Write, wire or phone us for prices
and information.

RAY-DI-CO ORGANIZATION
1547A N. Wells St. Chicago, Ill.

Real Estate for Radio

WANTED—High class radio receiving outfit, with range of at least 1000 to 1500 miles, complete with all necessary equipment, including aerials, batteries, Magnavox, etc. Also sending outfit, ordinary radius.

WILL EXCHANGE—Lot in a beautiful Florida resort, with or without furnished cottage, on equitable basis. Send full particulars in first letter.

T. V. ORR
DE FUNIAK SPRINGS, FLORIDA

A Variable Condenser

RIGIDLY INSPECTED

of hard Aluminum plates adds to the sensitivity of a receiving set. Special movable plates afford delicate adjustment on starting engagement. Proper rate of capacity increase is assured throughout the range. Lock nut and double end bearing of dial spindle maintain positive adjustment of movable plates and prevent short circuiting. Heavy gage metal end-plates afford superiority over material that warps.

Immediate Deliveries

Manufactured by

DIAMANT TOOL & MFG. CO., INC.
95 Runyon St., Newark, N. J.

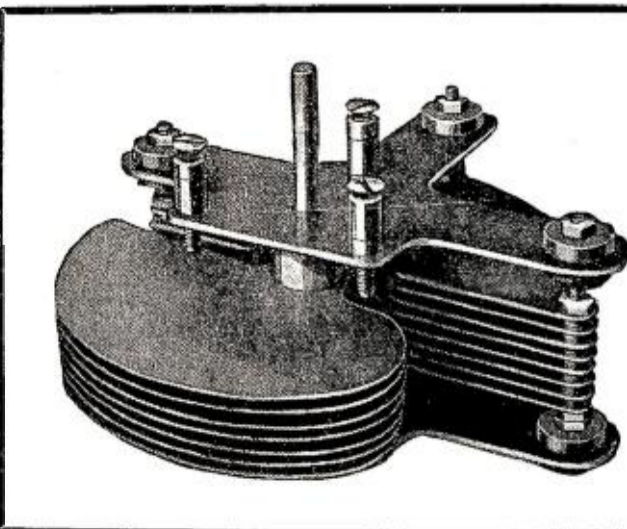

ten AM to eleven PM daily during this period and tickets may be obtained at the door price fifty cents each period worlds championship speed test in morse code will be held Wednesday evening May twenty fourth period Suttler Jose Seron and McElroy three of most experienced operators in United States are entered in this contest

24th—English—Members of this Bureau are cordially invited to attend radio show being held in seventy first regiment armory New York City week ending May twenty seventh and visit booth where naval exhibit is displayed period arrangements have been made to give special attention to members having their registration numbers with them as issued by this Bureau

25th—Included in program of radio show being held at seventy first armory New York City Friday evening is the judging of contest for the most efficient and best looking home made radio set that has been presented for this contest period prizes run one hundred dollars first prize fifty dollars second prize several twenty five dollar ten dollar and five dollar prizes period conditions of this contest are that each complete set must be made by one individual amateur (English)

26th—Following is partial list of new broadcasting station assigned call letters by department of commerce WCAV Kesselman ODriscoll Co Milwaukee Wis WCAZ Robt E Compton and Quincy Whig General Quincy Ill WDAA Ward Belmont School Nashville Tenn WDAB H C Summers and Son Portsmouth Ohio WDAC Illinois Watch Co Springfield Ill WDAD Win L Harrison Lindsborg Kans WDAE Tampa Daily Times Tampa Fla KDYW Smith Hughes and Co Phoenix Ariz WDAF Kansas City Star Kansas City Mo WDAG J Lawrence Martin Amarillo Tex WDAH Mine and Smelter Supply Co El Paso Tex WDAI Hughes Electrical Corporation Syracuse NY KDYX Star Bulletin Honolulu Hawaii WDAJ Atlanta and West Point RR Co College Park Ga KDYY Rocky Mountain Radio Corporation Denver Colo (English)

27th—English—Following is partial list of new telephone broadcasting stations assigned call letters by Department of Commerce WDAK The Courant Hartford Conn KDZA Arizona Daily Star Tucson Ariz WDAL Florida Times Union Jacksonville Fla WDAM Western Electric Co New York NY WDAN Glenwood Radio Corp Shreveport La WDAO Automotive Electric Co Dallas Tex JDAP Midwest Radio Central Inc Chicago Ill KDZB Frank E Siefert Bakersfield Cal WDAQ Hartman Riker Electric and Machine Co Brownsville Pa WDAW Lit Brothers Philadelphia Pa WDAS Samuel A Waite Worcester Mass WDAT Delta Electric Co Worcester Mass WDAU Slocum and Kilburn New Bedford Mass WDAW Georgia Ry and Power Co Atlanta Ga

28th—English—The states included in the radio inspection districts are as follows first district headquarters custom house Boston Massachusetts includes Maine New Hampshire Vermont Massachusetts Rhode Island Connecticut second district custom house New York City includes New York and Northern New Jersey Third District Custom House Baltimore Md includes Southern part of New Jersey and counties of Pennsylvania south of Blue Mountains Delaware Maryland Virginia and District of Columbia

29th—English—The states included in the Radio Inspection Districts are as follows Fourth District Hdqrs Custom House Baltimore Md includes North Carolina South Carolina Georgia Florida Porto Rico Fifth District Custom House New Orleans La includes Alabama Mississippi Tennessee Texas Arkansas Oklahoma New Mexico Sixth District Custom House San Francisco Cal includes California Hawaii Nevada Utah Arizona

30th—Following is list of new broadcasting stations WCAN Southeastern Radio Telephone Co Jacksonville Fla WCAP Central Radio Service Decatur Ill KDYL Telephone Publishing Co Salt Lake City Utah KDYM Savoy Theatre San Diego Calif KDYN Great Western Radio Corp Redwood City Calif KDYO Carlson and Simpson San Diego Calif WCAS Wm Hood Dunwoody Industrial Institute Minneapolis Minn WCAQ Tri-State Radio Mfg and Supply Co Defiance Ohio WCAR Alamo Radio Electric Co San Antonio Tex WCAT South Dakota State School of Mines Rapid City So Dakota KDYQ Oregon Institute of Technology Portland Oregon KDYR Pasadena Star News Publishing Co Pasadena Calif WHB Sweeney School Co Kansas City Mo WCAU Philadelphia Radiophone Company Philadelphia Pa KOK Federal Telegraph Company Clearwater California KDYS The Tribune Great Falls Mont WCAX University of Vermont Burlington Vermont KDYU Herald Publishing Company Klamath Falls Oregon WCAV J C Dice Electric Company Little Rock Arkansas WCAW Quincy Herald and Quincy Electric Supply Company Quincy Ill KDYV Cope and Cornwell Co Salt Lake City Utah (English)

31st—English—Commencing Saturday June third the radio amateur broadcast will be transmitted immediately after nine PM press broadcast is completed on eighteen hundred and thirty two meters damped wave

Transmission of Photographs by Radio

(Continued from page 230)

graph to any great distance. Other men have tried to use a strong current for



75¢ each

Perfect Broadcasting Reception with this Mica Condenser

Here we show the new Dubilier Micadon Type 600. It is a perfect Dubilier mica condenser. Use it and all the tube noises, due to fluctuations in the capacity of ordinary condensers disappear.

Dubilier Micadon Type 600 lasts indefinitely. Its capacity is *permanent* because the condenser elements are pressed together, so that they cannot dilate and contract with the oscillations in the antenna and thus cause the capacity to vary.

Dubilier Micadon Type 600 is provided with Fahnestock connectors and grid-leak clamps, but not with grid-leak. The grid-leak can easily be removed and replaced with the fingers.

Everything is soldered. The container is of molded composition. Provision is made for holding screws.

Price in capacities .001 and .002 mfd, 75c each, *without* grid-leak mounting.

Price in capacities from .0001 to .0005 mfd, 75c each, with grid-leak mounting.

Price in capacities from .0025 to .005 mfd, \$1.00 each.

Order from your dealer

DUBILIER CONDENSER AND RADIO CORP.

Department RN

217-219 Centre Street, New York

Branch Office, Munsey Bldg., Washington, D. C.

LICENSEES:

England—Dubilier Condenser Co., Ltd., London
 Canada—Canadian General Electric Co., Toronto
 Germany—Telefunken Co., Berlin
 France—C. Carpart, Paris

ANNOUNCEMENT

The DUO, a new condenser designed and built to meet the increasing demands for very high grade precision apparatus, is now ready for the market.

These condensers are made in the following styles:

- DUO-23-STRAIGHT.....\$5.50
- DUO-43-STRAIGHT..... 6.50
- DUO-23-VERNIER..... 7.00
- DUO-43-VERNIER..... 8.25

Purchase from your dealer or send direct to

H. F. GELDMEIER CO., 1008 French St., Erie, Pa.

NEW ENGLAND STATES' Salesmanager: Howard Rathbun, 402 Marlboro Road, Brooklyn, N. Y.

DEALERS NOTE—If your jobber cannot supply you order direct.

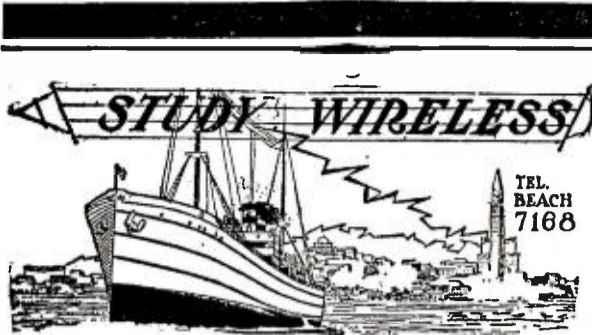

Positions Secured!

The tremendous new increase in commercial use of Radio has given rise to greater demands than ever for properly trained radio men as operators, installers, repairmen, salesmen and radio factory men.

95% of the graduates of this school are now successfully employed and a good paying position is ready for every student completing our course. Both land and sea jobs open.

Actual 1 K.W. Navy Standard Shipboard Equipment used in classroom instruction.

This school holds a record for qualification of First Class and First Grade Operators.

Send for 44 page Catalog Free

We take this occasion to congratulate
Mr. Theodore J. McElroy
 a graduate of this school
 on the great honor of winning the
World's Radio Receiving Championship.

MASSACHUSETTS RADIO and TELEGRAPH SCHOOL, Inc.
18 Boylston St. Boston, Mass.
 Formerly Boston School of Telegraphy. Est. 1903

FOR IMMEDIATE SHIPMENT



CONDENSERS
 43 plate - - - \$4.00
 23 plate - - - 3.50
 13 plate - - - 3.25

Without Dials
 3" Dials - - - .85

Tube Sockets, unbreakable. Panel or base mounting - - \$1.00

PhoneClamps make the phonograph a loud speaker. For Edison, Victor, Columbia. \$1.00

SEA HORN LOUD SPEAKERS.

Nature's perfect amplifier.

12 to 13 1/4" high \$ 8.00
 13 1/4 to 14 1/4" high 12.00
 15 to 16" high 15.00

SEND FOR FOLDER DEALERS WANTED

THE ORO-TONE CO.
 1010 George St., Chicago, Ill.

actual transmission; Korn employs a very small current and only to actuate certain delicate apparatus at a distance of not more than 24 inches. This latter apparatus has an entirely separated and distinct current to operate it and the extremely minute current from the selenium cell serves merely to regulate it. Thus he overcomes or avoids the tardy responsive action which is such a drawback to selenium. There is always a "drag" with selenium, but, as synchronization does not enter into the Korn method, the drag does not matter at all.

The apparatus to which this small current flows from the selenium is very complex and resembles somewhat that described by Mr. H. Gernsback in the July number of SCIENCE AND INVENTION in setting forth his plan for television. Briefly, it consists of 18 wires from the selenium cell, each carrying one of the eighteen intensities of current which have been regulated by the 18 values of light, and passing to 18 selective cells, each of which can receive one and only one of the intensities of current. Each of these cells controls the operation of a key like that of a typewriter and each key prints a letter, the letters corresponding to the eighteen values of light and shade found in the negative.

Suppose, for example, pure white to be represented by the letter A and dead black by the letter B; when the light passes through the lightest part of the negative the letter A is printed; when it strikes the darkest part of the negative, the letter R is printed, and so for every one of the intermediate values. The printing is done upon a tape.

Now the operator can send this tape by mail, if there is no hurry, to the receiving station. Or he can give it to a telegraph or radio operator who will send the letters upon it by an ordinary telegraph key to any point he may desire. Of course, in the case of radio, anyone with a radio set can pick it up anywhere; but no one will know what to do with it unless he has a Korn decoding instrument, for the message is merely a jumble of letters, stamped for convenience in fives or tens, each group being treated as a word. For example, here is a small bit taken at random from the message that transmitted this photograph from Rome to the Otter Cliffs station for the New York World:

mmmx xxmqo jjjjj jjjjj jggov
 mxxxv hdddd ddddd ddddt ddddt
 ddddt ttdt dttt tttt tttt tttm mmd

In other words, it is a code which may be sent from one point to another by any means which the exigencies of time and expense may make most convenient, and can be deciphered by any possessor of the Korn decoding machine. The latter is so simple that any mechanic, after using it for a few hours, could reproduce it in his own workshop at an expense of a few hundred dollars and, of course, the royalties due to the patentee. For it is little more than a typewriter with a wide keyboard, on which the operator copies the code message he has received. But instead of the letters corresponding to the keys that are struck, the machine prints dots, the size and spacing of which correspond exactly with the values of light and shade represented by the letters. In the case I have supposed, striking the letter A would result in a blank, striking the letter R would produce the largest of black dots. These letters, of course, are not the actual code used by Korn. A large sheet of paper inserted in the instrument receives the dots row after row. The number of dots required to build up the half-tone picture which results varies with the size of the photograph and also with the speed at which the commutation at the sending end has worked. For instance, a cabinet size photograph to be reproduced as a rather coarse half-tone needs about 3,000 dots; for a fine reproduction it needs

WATERS-GENTER Variometers

A superior instrument at a reasonable price.

All wood parts are of solid mahogany.

Our improved method of anchoring the loose ends of the coil makes it impossible for them to pull out. Ask your dealer.

WATERS-GENTER COMPANY
 1012 WEST LAKE STREET
 MINNEAPOLIS, MINN.

Experienced Manufacturers of Electrical Equipment

Hard to Get Wireless Supplies E-Z to Get by Mail Phones - Parts - Panels

We will ship by return mail and pay postage ourselves. Send money order or certified check. No stamps.

Reference: Merchants and Manufacturers Bank, Newark

Murdock No. 56 2000 ohm phones \$5.00
 Murdock No. 56 3000 " " 6.00
 Federal No. 53W 2200 " " 8.00
 Holtzer Cabot 2200 " " 8.00
 7-strand cable construction copper aerial wire, per 100-ft. coil .65

See last month's Radio News for our Panel advertisement. What radio parts do you need for your set? Send enquiry for price and delivery. We have a large stock of the parts you know.

L. FUNKE & CO.
 223 Washington St., NEWARK, N. J.

WHO ARE YOU LISTENING TO?

Do you know there is a chart showing the location of every Broadcasting Station in the United States, together with the wave lengths they send at, that will tell you at a glance what stations you can "get" on your set?

There May Be Some You Are Missing

Full instructions furnished with each chart. Sent prepaid upon receipt of 35c in stamps or money order.

Address Dept. R. N. 4

RADIUS MAP CO.
 827 St. Johns Place, Brooklyn, N. Y.

JOBBERS

RADIO SUPPLIES AND EQUIPMENT
Distributors Magnavox
AUTOMOTIVE ELECTRIC CO.
W D A O
 913-19 So. Ervay St. Dallas, Texas

Write For Our FREE BOOKS On
PATENTS
MUNN & Co.
 631 Woolworth Bldg. NEW YORK
 Scientific American Bldg., WASHINGTON, D. C.
 Tower Bldg. CHICAGO, ILL.
 611 Hanna Bldg. CLEVELAND, O.
 Hobart Bldg. SAN FRANCISCO, CAL.

about 6,000. The commutator can be set to regulate this.

The decoding machine turns out a picture that looks like a very much enlarged half-tone, and the newspaper that receives it has only to reduce it by photography to the size it needs.

The process can be simplified and made more accurate—for the reception either by wire or wireless of a long succession of absolutely meaningless letters is most unlikely to be without error, as any experienced operator will verify—by attaching the transmitter apparatus to an automatic telegraph sending machine, so that instead of printing letters upon a tape, the keys will send the dots and dashes corresponding to those letters directly over a telegraph wire or through the air as a radio message. And at the receiving end, an automatic telegraph receiving instrument can be made to type-write the large and small dots instead of the letters, just as is done by the typewriter. Thus the transmission would be absolutely automatic and direct and there would be no possibility of an error. This has not yet been done, but there is no reason why it should not be done at any time.

The garbling of the code message by errors on the part of the operator at the sending end or at the receiving end is not serious, however, for Mr. Hansen, who, through his work at Bar Harbor, has had more experience with the apparatus than anyone else in America, says that after a very little practice the man who is operating the decoding instrument learns to detect errors, and it is as easy to correct these during the process of decoding as it is for a stenographer to detect and correct errors in the spelling of words on a typewriter. Of course, if a code be very much garbled in transmission, a repetition is necessary just as it is with an ordinary telegram, or radiogram. When sending a coded photograph by radio it is a wise precaution to have two stations receive it, and to check the two records against each other, but this is not necessary. It is interesting to note that in the New York World's picture only three of the code letters from which it was made were found to be incorrect.

Prof. Korn has patented three distinct processes. Two of these are for automatic use with land wires, to which the instruments are connected at either end. Neither of these has yet been tried in America, because the instruments are in Germany and Italy and because the lines here are owned and controlled by private companies which have a deeply rooted aversion to allowing any instrument to be connected with their lines. In Europe, where the lines are all owned by the government and where there is nowhere anything like the congestion of traffic that keeps the American lines so busy day and night, these processes are looked upon as of greater practical importance than the third process, which is specially devised for use with radio. It is, of course, this latter which I have described above.

Korn has also a fourth process, this for automatically transmitting drawings in line, manuscripts, checks and other documents which cannot be reproduced in half-tone. This also has not yet been put to the test in America, but I have seen some remarkable reproductions of the work accomplished with it in Germany and Italy.

The transmission of photographs almost instantly—it took just forty minutes to transmit the picture reproduced by the World from Rome to Bar Harbor and to decode it—is still in its infancy, but the striking results of these first steps make it certain that in a few years, when the instruments shall have undergone the simplification that is sure to come about with practice and shall have been made portable, every newspaper will be using them as a part of its ordinary equipment, and every newspaper photographer going out to

SHIP OWNERS' RADIO SERVICE INC.

80 Washington Street, New York City

RADIO DISTRIBUTORS

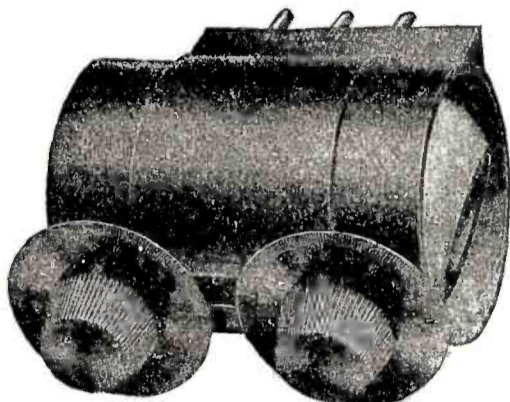

SORSINC "TUNIT"—\$15.00
Patent Applied For

The "Tunit" is a balanced primary attachment for use with the standard triple coil mounting, allowing ultra-efficient reception on wave lengths from 160 to 600 meters.

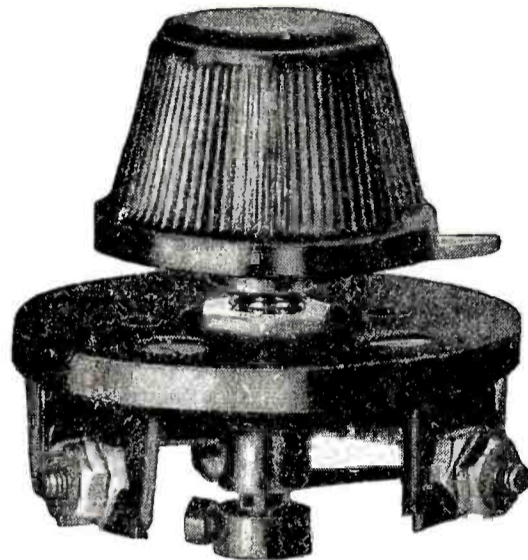

"FRAMINGHAM" RHEOSTAT
\$1.00

The only rheostat incorporating a panel bushing to give rigidity. The detail of construction and design makes this a highly desirable instrument. For table or panel mounting.

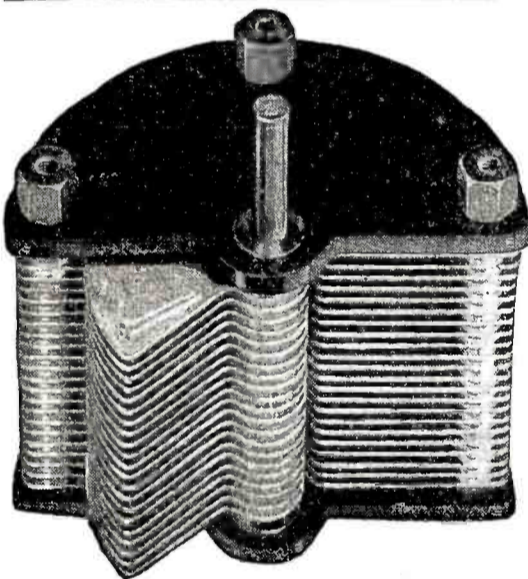

"ELITE" VARIABLE CONDENSER
\$4.75

43 plates; panel mount; 001 mfd. capacity. Plates accurately spaced, bakelite ends, metal end bushings, and spring tension adjuster at base. A well made condenser at an attractive price

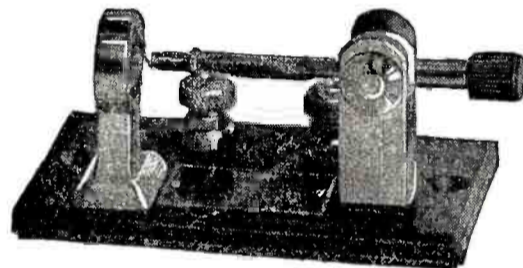

"SORSINC" CRYSTAL DETECTOR
\$2.50

The Sorsinc crystal detector is sold for amateur experimental, amateur entertainment use. This detector represents careful design and manufacture and incorporates a ball-joint arm. The spring tension is carefully adjusted and the crystal is guaranteed to be super-sensitive and dependable. Manufactured and licensed by the Wireless Specialty Apparatus Co.

Purchase from Your Dealer

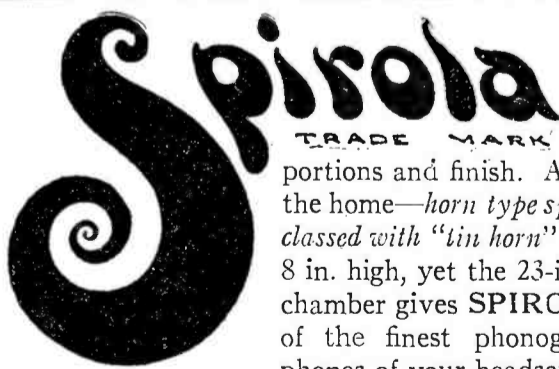

Most beautiful "Spirola Speaks" LOUD SPEAKER

made, cabinet type, fine proportions and finish. A real ornament for the home—horn type speakers will soon be classed with "tin horn" phonographs. Only 8 in. high, yet the 23-in. SPIRAL sound chamber gives SPIROLA the rich tone of the finest phonographs. Uses both phones of your headset—unsurpassed for

loudness. See this high grade article at your dealers—or we'll send you one postpaid.

L. H. DONNELL MFG. CO. Box 70 Ann Arbor, Mich.

\$3.85

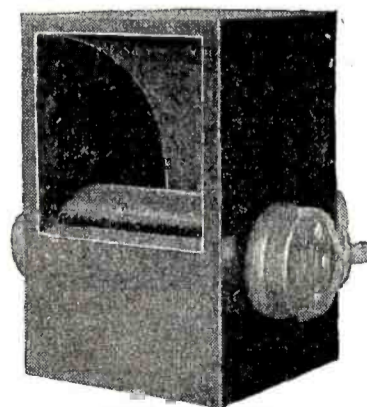

PAT. PENDING

Get a Handy Binder for your RADIO NEWS. Holds and preserves twelve issues, each of which can be inserted or removed at will. Price 65c. Experimenter Pub. Co., Inc., Book Dept., 53 Park Place, New York.

NATIONAL All-Metal SOCKET

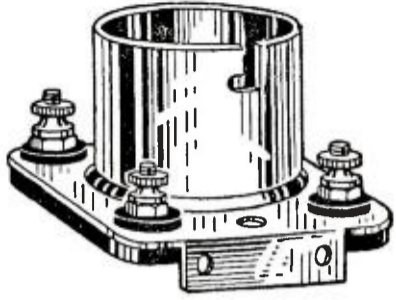

FOR PANEL OR TABLE MOUNTING

A socket that will add to the value of any set. Made entirely of brass nickel plated and properly insulated.

A broken socket makes your set valueless until the socket is replaced. Use NATIONAL All-Metal sockets and avoid trouble. Will last a lifetime.

Price.....\$1.00

If you have not as yet investigated the merits of NATIONAL Transformers, Variometers, Variocouplers, Rheostats and other NATIONAL products you should do so at once. You will be agreeably surprised at the high standard of quality maintained throughout.

NATIONAL RADIO MFG. CO.
5247 No. Clark Street
CHICAGO, ILL.



This Book On Home Beautifying Sent Free

Contains practical suggestions on how to make your home artistic, cheery and inviting—explains how you can easily and economically refinish and keep woodwork, furniture and floors in perfect condition.

--BUILDING??

If so, you will find this book particularly interesting and useful, for it tells how to finish inexpensive soft woods so they are as beautiful and artistic as hard wood. Tells just what materials to use—how to apply them—includes color card—gives covering capacities, etc.

Our Individual Advice Department will give a prompt and expert answer to all questions on interior wood finishing—without cost or obligation.

We will gladly send this book free and postpaid for the name and address of one of the best painters in your locality. And for 10c we will also send you postpaid a 2 oz. bottle of Johnson's Liquid Prepared Wax.

S. C. JOHNSON & SON, Dept. RN8, Racine, Wis.
"The Wood Finishing Authorities"

RICHARDS for GALENA AND SILICON

RICHARDS & COMPANY, Inc.
200 Causeway Street Boston, Mass.

"cover" an important event will carry in addition to his camera an instrument based on the Korn principle, so that photographs of things that happened this morning in San Francisco or New Orleans will be printed in New York in this evening's papers or in those of tomorrow morning. This is no dream; it could be done today if the Korn instruments were in New York, instead of being, as they are, in Berlin and Rome.

I Want To Know

(Continued from page 268)

ceiver, but signals which are already loud will not be made any louder. Audio frequency amplification merely increases the volume of signals which have already been detected.

Q. 2. Please show a circuit using the best of the above in which different steps may be plugged in or out at will.

A. 2. A number of circuits indicating both radio and audio frequency amplification may be found in this department in the July issue of RADIO NEWS, and in the diagrams now published. Plugs and jacks cannot be used in the stages of a radio frequency amplifier. The radio frequency amplifier amplifies the high frequency oscillations and rectification does not take place until the detector tube is reached. The telephones cannot, therefore, be used until the signals have been rectified.

CIRCUIT TO SUPPLY FILAMENT WITH A. C.

(435) Mr. John Cornell, Blairstown, New Jersey, wants to know:

Q. 1. Can honeycomb coils be used effectively in the circuit, shown in May RADIO NEWS in answer to question 371?

A. 1. This circuit illustrated the method of supplying the filament of a vacuum tube with A. C. by means of a step-down transformer. Tuning inductances may be of any type.

Q. 2. What capacity has the fixed condenser across the B battery and phones?

A. 2. This may be a .001 M. F. condenser.

Q. 3. What resistance has the potentiometer?

A. 3. The potentiometer should have a resistance of 400 ohms.

TUBES FOR PORTABLE SETS

(436) Mr. J. W. Potts, Rawlins, Wyoming, wants to know:

Q. 1. Where can I obtain small vacuum tubes suitable for small portable receiving sets?

A. 1. Vacuum tubes known as RAC-3 Audions are quite efficient and suitable for portable sets. They only require four volts on the filament and each tube only consumes a small value of current.

Q. 2. Where can I obtain circuit diagrams of C. W. telegraph and telephone transmitters?

A. 2. Circuits of this description may be obtained from the Consolidated Radio Call Book Company, 98 Park Place, New York City.

REGENERATION WITH LOOSE COUPLER

(437) Mr. Ross Wiegand, Ottumwa, Iowa, wants to know:

Q. 1. Please publish an efficient regenerative hookup using a loose coupler and such other instruments as are needed to make it regenerative.

A. 1. This circuit was given in answer to Question 346 in the April-May issue of RADIO NEWS.

Q. 2. How can one determine whether or not a circuit is regenerative?

A. 2. A circuit should be regenerative if it is wired up to produce regeneration. This is obtained either by means of a tickler coil in the plate circuit which is in inductive relation to the primary or secondary inductance of the circuit, or regeneration may be produced by tuning the plate circuit to the frequency of the incoming oscillations. In actual practice, when the controls of a receiver are varied, the oscillation point is recognized by a click in the phones. If the operator touches the grid connection when the tube is oscillating, he will hear a double click as his finger touches and leaves the connection. This double click would not be heard if the tube were not oscillating.

Q. 3. Is a loose coupler almost as efficient as a variocoupler and two variometer arrangement?

A. 3. A loose coupler may be used quite satisfactorily. The small standard type of variocoupler is sometimes better for short waves, as this is wound with only a small number of turns to avoid distributed capacity. By means of a variocoupler and variometer it is also possible to easily obtain loose coupling. If an ordinary loose coupler is the proper size and proper provision is made to eliminate dead-end loss, good results can be obtained with this type of receiving transformer.

WAVE LENGTH OF A COIL.

(438) Mr. Herbert Dill, Hingham, Mass., wants to know:

Q. 1. Kindly give formula by which I can closely estimate the wave length a single coil

Standard Radio Horn



Patent applied for
Special Design

Will fit any receiver. Heavy material, no blast. Rubberoid Enamel finish.



No. 15 (as illustrated)
5" Bell, 14" High.
Price.....\$5.00.

No. 17, 7" Bell,
19" High.
Price.....\$7.50

Your dealer can supply you
We figure on SPECIAL HORNS
FOR MANUFACTURERS

Standard Metal Mfg. Co.
Oldest and Largest Manufacturers of Horns in U. S.
237 Chestnut St., Newark, N. J., U.S.A.



RADIO BATTERIES

The "Arco" Radio Batteries is especially designed for radio work. In this battery we use a special radio plate. This assures you a battery best adapted for radio use.

6 volt	40 amp.....	\$13.00
6 "	60 "	15.00
6 "	80 "	22.50
6 "	100 "	27.00
6 "	120 "	32.00
6 "	150 "	39.00

Write for Dealers Discount
ELECTRIC SUPPLY & FIXTURE CO.
123 E. Washington St.
FORT WAYNE, IND.

RADIO DEALERS MANUFACTURERS

Attractive prices and prompt deliveries on coils, parts and completed receiving sets.

Tuning Coils Secondary Coils
Vario-couplers Primary Coils,
Rotors

Coils Wound to Order
Beautifully finished and efficient complete sets from.....\$1.25 to \$35.00

Write for Price List
Ra-Tone Electric Co. 816 Park Place West
Radio Department Detroit, Mich.

VULCANIZED



Be sure and specify

"WILMINGTON FIBRE"

Sheets, Rods, Tubes, Washers, Etc.,
Specialties

Wilmington Fibre Specialty Co., Wilmington, Del.
Branch Offices "Everywhere"

winding will give, provided I know the diameter and circumference of the tube, the gauge of wire, the separation of the turns, and any other factors necessary to compute with. Many of us would like to wind single layer coils to give 100, 300 and 1,000 meters, quite exactly.
 A. I. We refer you to the answer to Question 412 in the July issue of RADIO NEWS.

Practical Hints for Amateur Constructors

(Continued from page 265)

"B" BATTERY SAVING

At the local ten-cent store, buy eight round 2-cell flashlight batteries (not oblong as for small flashlights). They will cost 20 cents apiece. Make a shallow box with the inside dimensions $1 \times 19\frac{1}{2} \times 2\frac{5}{8}$ ". At each end of it drill two quarter inch holes $\frac{5}{8}$ " from both the inside surface of the bottom and inside surface of the sides, as illustrated. In holes 1 and 4 place brass machine screws with heads on the inside. In holes 2 and 3 also put brass machine screw in but with a brass spring of the expanding type about an inch long under the head. Now place four of the batteries in the space from hole 3 to hole 1 with their negative ends pointing toward hole 1. Also place the remaining four batteries in, with the negative ends in the opposite direction. Connect the screws Nos. 3 and 4 together. From scraps of brass secure a brass strip measuring about $\frac{1}{4} \times 2$ " and fasten the negative lead to it. This can be slid in between the cells at the desired voltage. The battery is now a complete 24 volt "B" battery that will outlast any of the standard-make three dollar batteries on the market. It costs only \$1.60 and a little time. When the cells give out they can be easily removed and fresh cells put in with no soldering. If higher voltage is desired more cells may be used and the box may be made larger.

Contributed by JAMES V. CLARK, Granville, Ohio.

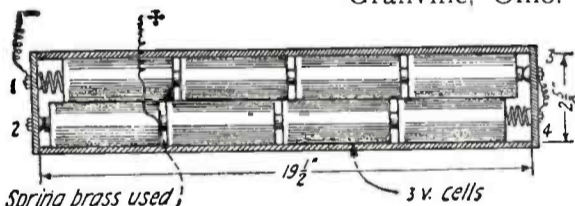

This is a Clever Method of Making a Plate Battery. If One of the Batteries Runs Down It Can Be Replaced.

PLUGGING IN THE AERIAL

The idea illustrated below for a radio receiving set will do away with long outside wires from the set to the aerial and ground connections.

Where the aerial lead-in enters the house, I have screwed to the wall an ordinary elec-

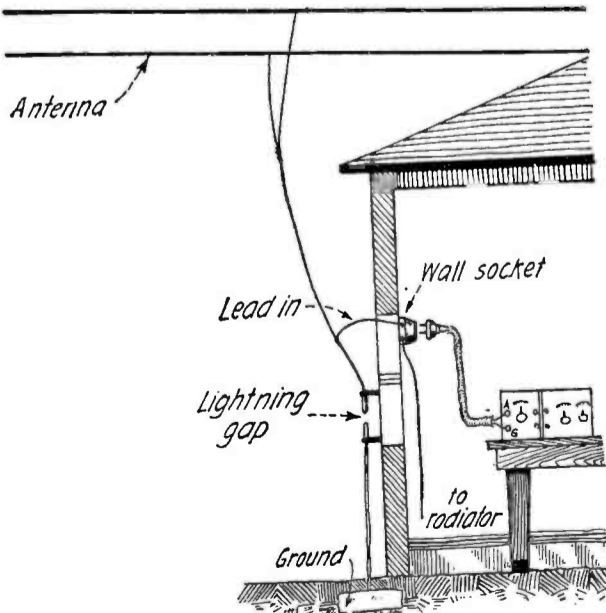

This Is an Unusual and Handy Method of Connecting the Aerial to the Receiver; an Ordinary Electric Light Plug Is Used.

Price
\$12⁰⁰

**3000
 ohms**

**DICTOGRAPH
 HEADSET**



**Best in the World for
 All Types Receiving Sets**

BE sure the headset you buy carries the world-famous name "Dictograph." Then you will know that you are getting the finest Radio Products made.

Do not sacrifice quality for a slightly lower price. The Dictograph Radio Head Set is beyond comparison with ordinary head sets. Its scientific accuracy and its fine construction are exclusive products of Dictograph skill and experience.

**A Reputation
 that Guarantees Quality**

FOR years the name "Dictograph" has been the world's standard for super-sensitive sound transmitting and receiving units. The Dictograph organization has specialized in making the most delicate instruments of this kind ever known. The "Acousticon" for the Deaf has provided means of hearing to thousands. The Detective Dictograph catches and records the slightest sounds anywhere within a wide radius; the Dictograph System of Telephones is the original system of loud speaking Telephones.

The Dictograph Head Set improves results secured by receiving set, whether Crystal Detector, Regenerative, or Non-Regenerative. See The Dictograph Radio Head Set at your dealers—look for the name "Dictograph"—the guarantee of supreme quality. If he cannot supply you, write to us direct.

DICTOGRAPH PRODUCTS CORPORATION

Executive Offices

220 West 42d Street

NEW YORK, N. Y.

Have your
 dealer order
 for you the
 new



**DICTOGRAPH
 RADIO
 LOUD
 SPEAKER**

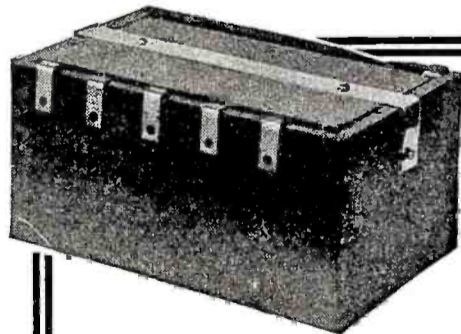

PREVENT WASTE
 USE THE
 NON-SOLDERED AND NON-WIRED

**ENCO
 "B" BATTERIES**

REFILLABLE WITH STANDARD FLASHLIGHT UNIT CELLS

"WIRELESS BATTERIES FOR WIRELESS"

603-607 W. 130th St. ENCO ELECTRIC NOVELTY CO. NEW YORK

MONEY FOR YOU—Add to your salary—Make extra pin money—Start a lucrative business of your own. Spend an hour each day taking subscriptions for the Radio News. We'll pay you well and you'll enjoy the work. Write for full particulars. Circulation Dept., Radio News, 53 Park Place, New York City.

Dr. T. O'Connor Sloane Will Teach You CHEMISTRY



Right In Your Own Home

DR. T. O'CONNOR SLOANE, A. B., A. M., LL. D., Ph. D.,
Educational Director
Chemical Institute of
New York, formerly
Treasurer American
Chemical Society and
a Practical Commercial
chemist as well as
a noted instructor.

Good chemists command high salaries. Industrial firms of all kinds pay tempting salaries to get the right men. Salaries of \$10,000 a year are not unusual for chemists of exceptional abilities. The work of the chemist is extremely interesting. If you are fond of experimenting, take up chemistry. If you want to earn more money, the way is open through our Course in Chemistry.

You Can Learn at Home
Dr. Sloane will teach you Chemistry at home in a practical, intensely interesting way. Our Course is remarkably simple. No special education required—if you can read and write plain English you can thoroughly understand and master every lesson.

can read and write plain English you can thoroughly understand and master every lesson.

Easy Monthly Payments

The price of our course is very low and the tuition includes everything, even the chemistry outfit—there are no extras to buy with our course. You can pay in small monthly amounts as you go along. Our plan places a chemical education within the reach of everyone.

Experimental Equipment Given to Every Student

One special feature of our course is that we give to every student, without additional charge, the chemical equipment he will need for his studies, including forty-two pieces of laboratory apparatus and eighteen different chemicals and reagents. The fitted, heavy wooden box serves as a carrying case for the equipment and as a laboratory accessory for performing experiments.

SPECIAL 30-DAY OFFER

In addition we are making a special offer for a short time only. You owe it to yourself to find out about it. Mail the Coupon to-day for free book, "Opportunities for Chemists," and full details of our special offer. Act immediately before this offer is withdrawn.

—CUT HERE—

Chemical Institute of New York, Inc.
(Home Ext. Division B-A), 140-R, Liberty St., N.Y.: City
Without obligation or cost, send me your free book, "Opportunities for Chemists," and full particulars about the Experimental Equipment given to every student, your plan of payment and special 30-day offer.

Name.....
Address.....
City..... State.....



WORLD NOISELESS RADIO BATTERY

SAVES YOU 50% OF COST

And you get an unconditional written 2-year guarantee. Factory to user selling methods and low operating costs make possible the remarkably low prices that we quote below, and the proven worth of the World Battery warrants the iron-clad guarantee that we give to every purchaser.

Designed Especially for Radio

The World NOISELESS Radio Battery was designed with the special requirements of radio operation in mind. It is not an experiment! It is made by an old established company that for years has been making the very highest type of automobile batteries. Remember that the success or failure of your set depends on the quality that you buy. The correct construction of the World makes them non-leak, non-conductive non-deteriorating and prevents hissing and frying noises. We back these statements with a written guarantee.

Special "Rubtex" Battery Case

Because of the extensive demand for a battery case that will insure home radio users against acid leakage we have designed the "Rubtex" Battery Case. It is absolutely indestructible and acid proof. \$2.50 added to the prices quoted below on the Globe Batteries in wooden cases will insure you against leakage.

WORLD RADIO BATTERIES					
Volts	Amps.	Price	Volts	Amps.	Price
6	40	\$8.50	6	80	\$13.00
6	60	10.00	6	100	15.00

Shipped Fully Charged Ready for Installation

Begin now to get 100 per cent. battery service at half cost by sending us your order today.

WORLD BATTERY COMPANY

1219 S. Wabash Ave., Dept. R, Chicago, Ill.

MARKO STORAGE BATTERIES

6 volt 30 amp. guaranteed 2 yrs.	10.00
6 volt 60 amp. guaranteed 2 yrs.	13.50
6 volt 80 amp. guaranteed 2 yrs.	17.00
6 volt 100 amp. guaranteed 2 yrs.	21.00
Acme Amplifying Transformers (mounted)	4.25
Federal Amplifying Transformers	5.95
Radiotron U. V. 201 Amplifying Tubes	5.95

HYGRADE ELECTRICAL SUPPLY CO.
41 WEST 125th STREET, NEW YORK, N. Y.

tric light wall socket, and connected the lead-in to one of the two screws in the socket. To the other screw is connected the inside radiator ground wire. A small piece of ordinary drop cord is connected to the aerial and ground binding posts, and a drop-light plug is attached to the other end of the wire. The plug is marked with a pen-knife, with an A for aerial connection and a G for the ground connection.

When the set is to be used, simply insert the other end of the plug, which has been screwed into the wall socket and also marked for the A and G connections. This is done in the same manner in which a reading lamp is plugged in on the house lighting circuit. When through with the set for the evening, simply pull out the plug.

Contributed by **HERBERT L. LITTELL,**
Brooklyn, New York.

United States First In Radio Work

By **CARL H. BUTMAN**

THE United States at this moment has practically complete freedom from foreign control of radio communication between this country and others, and, furthermore, American commercial and naval services are exercising an almost predominant influence in world radio communication. This was the statement of Rear Admiral J. K. Robison, Chief of the Bureau of Engineering of the Navy, in a recent interview.

"This has been brought about to no small extent by the cooperation and assistance of the Navy Department," he declared, pointing out that ever since 1902 the Navy has used radio as a medium of rapid communication, and that since 1904, when President Roosevelt put all shore radio stations except land military stations under its direction, the Navy had controlled all governmental stations.

The Naval Communications Service has been developed rapidly, but as many stations as possible have been transferred or closed, including 23 since the close of the war. The naval stations on the Great Lakes would be transferred if someone else could be found to operate them, he said, stating that these stations were all institutions for the saving of life and property on the Lakes and could not be abandoned.

NAVY ASKS FOR \$3,828,460 FOR RADIO

"I have estimated the cost of maintaining the Navy's 214 coastal stations for the fiscal year 1923 at \$2,822,360, over \$100,000 less than was appropriated last year," Admiral Robison stated, "and have asked Congress for that amount, as well as \$1,006,100 for new radio and sound equipment and its maintenance on board ships." He continued: "It now looks as if the Congress would cut the total sum by about one million, necessitating great economies in our program."

"The operation of the shore stations pays a dividend into the Treasury more, by 100 per cent, than the amount of its expenses every year," he stated. Going further into details, the head of the Navy's radio research and maintenance department explained that the shore stations did not interfere with other government or commercial services, and that they were necessary to the safety of merchant and war ships, both in times of peace and war.

Today the Navy has 214 shore communication stations, including 90 on the coasts, 46 on light vessels, 54 radio compass stations, 3 radio laboratories, 10 carrier pigeon stations, and 11 super-power trans-Atlantic stations, all of which practically pay for themselves besides being essential in the interests of the country.

10c. CHARGES RADIO & AUTO STORAGE BATTERIES AT HOME WITH AN \$15 F-F BOOSTER

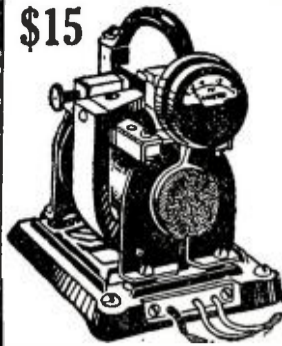

F-F BATTERY BOOSTERS
Charge Automatically Operating Unattended. Leave Your Battery just where it is, without even disconnecting it, Screw Plug in Lamp Socket: Snap Clips on Battery Terminals: Turn Switch and Battery is Charged in Morning. Is it not gratifying to feel that Your Radio Batteries will never fail and You will be always Ready to Receive All Radiophone Broadcast Music Sermons & News, never having to be careful of, or tell Friends Your Batteries are dead?

Both Waves of Current are Rectified thru Adjustable & Easily Renewable Infusible Carbon Electrodes, which Maintain a Constant Efficiency & Last thousands of hours. Also Charges Batteries right in Auto. No Skill Required. AM METER Shows Current Flowing. Eliminating Guess Work. COMPLETE, COMPACT, SELF-CONTAINED PORTABLE AUTOMATIC CHARGING UNITS. F-F Battery Boosters are Full Wave Magnetic Rectifiers for 105-125 Volt 60 Cycle A. C. REDUCED PRICES. Type 6 Charges Radio "A" 6 Volt Battery at 6 Amperes \$15 Type 8 Charges Radio "B" Batteries Up to 100 Volts \$15 Type A-B Charges Both Your "A & B" Radio Batteries \$20 Type 12 Charges 12 Volt Batteries at 5 Amperes \$15 Type 166 Charges 6 Volt Batteries at 12 Amperes \$24 Type 1612 Charges 12 Volt Batteries at 7 Amperes \$24 Type 1626 is a Combination of Types 166 & 1612 \$36 The Larger Types are for heavy Batteries, or where time is limited. Shipping Weights 11 to 15 Pounds. Order from your Dealer or Send Check for Prompt Express Shipment. If via Parcel Post have remittance include Postage & Insurance Charges. Or have us ship Type desired C. O. D. Other F-F Battery Boosters Charge Batteries from Farm Lighting Plants & D. C. Circuits. For GROUP CHARGING use our 100 Volt Automatic ROTARY Rectifier, 12 Battery, 8 Ampere Size \$135. Order Now or Write Immediately for FREE BOOSTER & ROTARY Bulletins 32 & 32A.

THE FRANCE MFG. CO., OFFICES & WORKS
Cleveland, Ohio, U. S. A.
Canadian Rep: Battery Service & Sales Co., Hamilton, Ont.

"ATTENTION AMATEURS"

- Stromberg-Carlson Phones . \$7.50
- Thordarson Amp. Transformer 4.50
- Paragon Sockets 1.00
- Radiotron No. 201 6.50

QUAKER LIGHT SUPPLY CO.
728 Arch Street
Philadelphia, Pa.

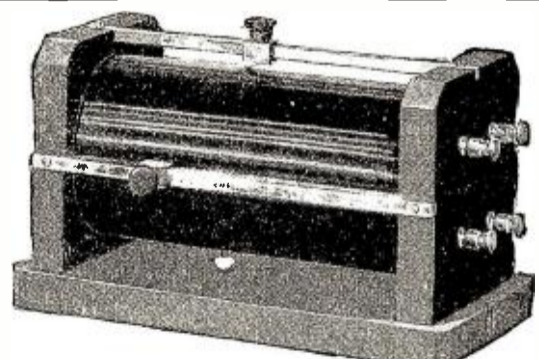

LAMB TUNING COILS
Two nickel sliders and rods; four nickel binding posts. Coil contains about one-half lb. No. 22 enameled magnet wire. Mounted in hardwood ends and base. Price, \$3.00.
Liberal Discounts to Dealers
F. JOS. LAMB COMPANY, 1960 Franklin St., DETROIT, MICH.

RADIO FREQUENCY AMPLIFIERS and Clapp-Eastham, Westinghouse, and Grebe Receiving Sets

Complete Receiving Outfits for Delivery
MASSEY RADIO COMPANY
Winchester, Virginia

EARNS \$23,000 PER MONTH

For the first six months of the current fiscal year, naval radio stations earned the sum of \$144,659, an average of \$23,000 per month. In 1921 the number of words carried decreased by 24,946,657, due to the discontinuing of many war-time activities, the reduction of Shipping Board operations, and the elimination of much telegraph and radio traffic in the interests of economy. Therefore, the earnings or "savings" decreased in 1921 some two million dollars over what they were the year previous, being only \$3,509,386, a sizable saving, nevertheless, it was pointed out.

"It is worthy of note, the Admiral interjected, "that the interests of the U. S. Navy in radio communication have resulted in the United States commercial interests becoming predominant in world radio communication."

The Navy's net is almost world wide, and connects all the Government's outlying possessions with the United States, furnishing as well a medium of rapid communication with our fleets of war and merchant marine.

SOME RADIO DEVELOPMENTS

Replying to a question as to what the Navy had done specifically to develop the art of radio telegraphy and telephony, Admiral Robison stated that a few of them included improvements in facilities for secret communication; increased the range of aircraft radio sets from 50 to 500 miles, and reduced the weight materially, making long-range spotting possible; developed a pilot cable for harbors and aircraft landing fields, increasing the safety of both water and aerial navigation; made possible the sending and receipt of five simultaneous messages; increased long-distance speed from 10 to 60 words per minute; and made possible automatic transmission and reception. Other work includes the development of the kite aerial for transmitting from a seaplane on the water; radio compass improvements, making radio applicable as a direction indicator and position finder; the elimination of static and "mush"; an advance in the radio controlled torpedo and vessels; and the introduction of the arc transmitter and uni-wave system of signalling.

Under ship radio equipment, Admiral Robison said: "There remains to be accomplished for the next fiscal year the installation of new equipment on vessels in active service on which there has been no opportunity to do work. The use of vacuum tube transmitters is becoming general and this requires the conversion of the present Navy spark sets now installed on all ships. This applies especially to submarines. By using a tube set the radio range of submarines will be increased about five times, or from 75 to 400 miles. Submarines are being equipped with aerials and receivers of such type that receiving under water will be practicable and transmitting without coming fully to the surface will be possible.

"One effort in the past two years has been to develop and test a standard type of listening device equipment for each type of naval vessels, for detecting the presence of submarines, which proved most necessary during the world war. The bureau is now ready to install this apparatus, which is of a confidential nature, on several destroyers and a few battleships," he concluded.

COMMERCIAL BROADCASTING

Radio concerts are to be placed on a paying basis in Chicago, if all goes well with the promoters of the idea. Subscribers will pay for the evening entertainments the same as they now pay for theatre or movie shows. A new method of broadcasting is planned to be sent out simultaneously on three or four different wave lengths so distorted as to be unintelligible—later converted in a

ONE DOLLAR

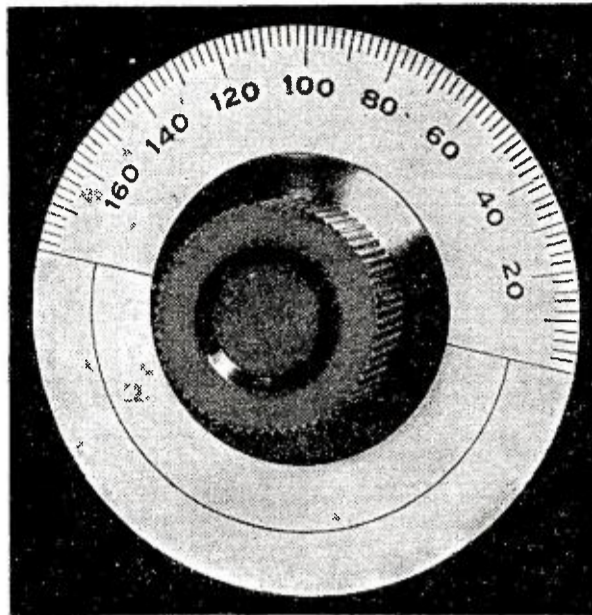

Puts This Dial On Your Set

A Dial Designed by Specialists in Radio Devices of This Character.

A Quality Product At a Production Price.

AT ALL RADIO DEALERS OR POST PAID FROM US \$1.00

SPECIFICATIONS—Bakelite knob, with concealed set screw and heavy brass bearing for 1/4-in. or 3/16-in. shafts. Dial of brass, heavily silver plated and lacquered, diameter, 3 1/4-in.

ADDITIONAL EQUIPMENT

UU200 Radiotron Detector Tube.....	\$5.00
Stromberg-Carlson Head Set.....	7.50
Willard 6V. 50 A.H. Storage Battery.....	21.25
Burgess Large 22 1/2 V. "B" Battery.....	3.00
	\$36.75

SOMERVILLE ANTENNA OUTFIT

125 Ft. 7 Strand Copper Wire.....	.75
2 Brown Porcelain Insulators.....	.20
1 "Anchor" Lightning Arrester.....	1.50
25 Ft. Waterproof Ground Wire.....	.50
1 Lead-In Insulator Tube.....	.20
1 Ground Clamp.....	.10
	\$3.25

DEALERS—We put this combination up first for the Somerville Radio Stores, selling retail only. They sold so fast that you should sell them too.

Parts of a Single Circuit Regenerative Receiver Which Can Be Assembled and Wired at Home by Anyone

Chirad Variometer, Assembled.....	\$5.00
175-3000 Meter Bank Wound Load Coil.....	3.75
Coto-Coil Series Antenna Condenser.....	4.50
2 Somerville 4" Dials, with Pointers.....	3.50
1 Dead Ending Switch, for Load Coil.....	.75
12 Contact Points and Stops.....	.45
8 Somerville Metal Terminals.....	1.20
8 Somerville Terminal Indicators.....	.50
1 Bradleystat Filament Control.....	1.85
1 Paragon Tube Socket.....	1.00
1 Grid-Leak Condenser, .0005 Mfd.....	.40
1 By-Pass Condenser, for Phones.....	.70
1 Condensite Celeron Panel.....	3.00
1 Quartered Oak Hinged Cabinet.....	7.50
	\$34.10

TYPE KD-CR-5 RECEIVER

DEALERS

We are jobbers of most of the high grade lines of standard equipment, and will fill your orders promptly on a cash basis only, allowing the usual cash discount.

—WE PROMISE PROMPT SHIPMENT ON—

FEDERAL

Junior Crystal Receivers.....	\$25.00
Double Headsets, 2200 Ohm.....	8.00
Double Headsets, 3200 Ohm.....	10.50
No. 15, Universal Plug.....	1.75
No. 1421 } Plain Jacks.....	.70
No. 1422 }85
No. 1423 }	1.00
No. 1425 } Fil. Control Jacks.....	1.00
No. 1428 }	1.20
No. 226, Amplifying Transformer.....	7.00
No. 300, Filter Coil.....	7.50
No. 8, Detector-Amplifier Box.....	52.00
No. 9, 2 Stage Amplifier Box.....	58.00
Antenna Outfit (new code).....	7.00
No. 400, Pleiophone Loud Speaker.....	14.00

WILLARD

24 Volt "B" Battery.....	\$10.15
6 Volt 20 A. H. "A" Battery.....	13.15

BRADLEYSTAT

Vernier Filament Control.....	\$1.85
-------------------------------	--------

CHIRAD

Knocked Down Variometer.....	\$4.00
Assembled Variometer.....	5.00

BRACH

Lightning Arrester Gaps.....	\$2.50
(Outside Type).....	3.00

Accounts opened with Jobbers only who place \$1000 Orders. C. O. D. shipments made only if 25% of list value accompanies order.

CONSUMERS!

If your dealer does not carry above items, we will ship direct, postpaid.

SOMERVILLE RADIO LABORATORY

REMOVED TO LARGER QUARTERS AT
43 CORNHILL ST., BOSTON, MASS.



MONEY for You

Add to your Salary—Make extra Pin Money. Start a lucrative business of your own. "Radio News." We'll pay you well and you'll enjoy the work. Write for full particulars. Circulation Dept., RADIO NEWS, 53 Park Place, N. Y. C.

BOYS AND GROWN UPS

Memo-Code

(Patent Applied For)

Makes You a Real Radio Operator

KNOW MORE THAN!
THE OTHER FELLOW!

By my System and Chart, you will know the Code in 30 minutes. Get the real thrill of "Radio News"

Complete System, \$1.00

BLINKO Practice Set

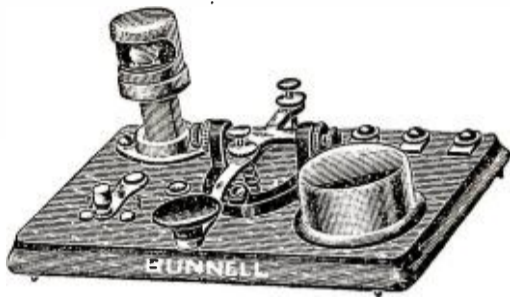

Can be used to throw in buzzer or lamp at will for practicing blinker light and buzzer signals

Complete Set with Memo-Code **\$5.00**

H. C. FAIRCHILD
588 Broad Street NEWARK, N. J.

special type of receiver. Only those who lease the receiving apparatus can get the service. One of the apparently unsolvable questions in the realm of radio has been the matter of revenue for the broadcasting stations, apart from the purely advertising value of the station.

At first it was comparatively easy to find performers to lend their talents to the broadcasting plan, and it seemed good publicity, too. But lately a change has been noted and now it is harder to find good singers and speakers after the novelty of the first few months has worn off. Song publishers demand royalties, singers demand contracts based on monetary considerations.

The Actors Equity League is demanding that its members be paid for their services, and in many other ways life for the broadcasting management has grown more irksome. The new method of transmission, though still in theory, is eagerly looked for.

ISLAND WITHOUT A COUNTRY HAS CALL "U. S."

Off Honduras in the Caribbean lies a little piece of land called Swan Island, where Americans have lived for many years, although the nationality or ownership of the island has never been decided. On this "island without a country" the United Fruit Company has a commercial radio station and uses the call "U S," which, however, is not a United States call but an outlaw call chosen by the company in 1909. Although Italy owns the three letter calls from UPA to UZZ, "U S" does not come within the control of that country any more than does the island itself.

If the island came into the possession of the United States, the station would lose its identifying call, as all United States calls begin with the letter "N," "K" or "W."

RADIO PUTS OVER REAL ESTATE DEAL

Unable to dispose of a good, but not modern, house in Dallas, Texas, in spite of alluring offers which brought no bidders, an enterprising real estate operator equipped the old mansion with the very latest radio receiving set and so advertised in the leading paper. Replies came immediately and from dozens of offers he was able to dispose of the house with a good profit.

NEW YORK RADIO PILOT CABLE FOUND O. K.

A recent test of the radio piloting cable in Ambrose Channel showed that the mass of a large steel ship does not materially affect the audibility of the signals picked up from the cable, and that greater power in the cable is not necessary.

By means of underwater sound-detecting devices, a ship is enabled to keep practically over the submerged cable from which signals are constantly sent out through the water. There is a receiver on each side of the ship's bottom, and when one signal is weaker than the other the course is changed slightly until they are equal in intensity. In this manner a ship can proceed up the Sound even in dense fog.

As only tests with comparatively small steel vessels and tugs had been conducted by the Navy Department heretofore, it was feared that the mass of a large steel ship would absorb the magnetic field set up by the cable with the result that no signals would be picked up by the ship's receiving coils. The experiments, which were conducted by naval officers from New York on the U. S. S. *Manchuria*, also demonstrated that in the case of two ships passing each other the

"E-S-X"

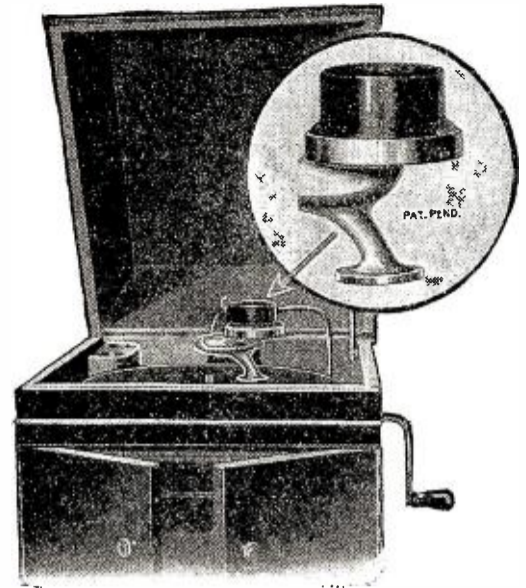

RADIOIZE YOUR TALKING MACHINE

Let your family and friends enjoy the Wireless Broadcasting on your phonograph. Attach your Wireless Receiving set to your phonograph with the ESX attachment.

Will Fit Any Phonograph
Silver Finished.....\$3.00
Gold Plated.....\$4.00

Write for Particulars

ESSEX WIRELESS SPECIALTY CO.
31 NEW STREET, Dept. A, NEWARK, N. J.

RADIO SUPPLIES

REAL SERVICE GUARANTEED

201 Radiotron Tubes.....	\$6.50
6-amp. Tungar Charging Rectifier.....	28.00
6-volt, 110-amp. Storage Battery.....	20.00
Simplex Variometers.....	6.00
Simplex Variocouplers.....	6.00
Klosner Filament Rheostats.....	1.50
Fada Filament Rheostats.....	1.00
Jenkins Filament Rheostats.....	1.50
Bakelite Base V. T. Sockets.....	1.50
Fibre Base V. T. Sockets.....	1.00
4-inch Bakelite Dials and Knobs.....	1.35
3-inch Bakelite Dials and Knobs.....	1.00
Cotoco Condensors, .001 MF.....	6.00
Cotoco Condensors, .0005 MF.....	4.50
Audiotron 2-Filament Tubes.....	5.00
Western Electric Head Sets.....	12.00
Connecticut Head Sets.....	7.00
Federal Telephone Jacks.....70c, 85c,	1.00
Ever Ready B. Batteries, 22½-volt....	\$1.75, 3.00
Ever Ready B. Batteries, 45 volt.....	5.00
Brach Arrestors.....	2.50
Audio Amplifying Transformers.....	7.00
Nickel-Plated Switch Points, ¼x¼ head, per dozen.....	.30
Nickel-Plated Binding Post.....	.10
R. C. Westinghouse Receiving Sets.....	132.50
Sr. Westinghouse Receiving Sets.....	65.00

Above Material in Stock.

Prompt Shipment or Money Refunded.

Send us your order with check; we pay the parcel post.

JERE WOODRING & COMPANY
Hazleton, Penna.

VOLUTONE

The Newest Thing in Radio. Phonograph Cabinet and Loud Speaker Combined. Assemble present or any standard equipment in this compact cabinet. Proved demand. Deliveries NOW. Dealers—Write quick for prices on this fast seller.

THE VOLUTONE COMPANY
141 West Ohio Street CHICAGO, ILL.

FREE

Drawing Outfit

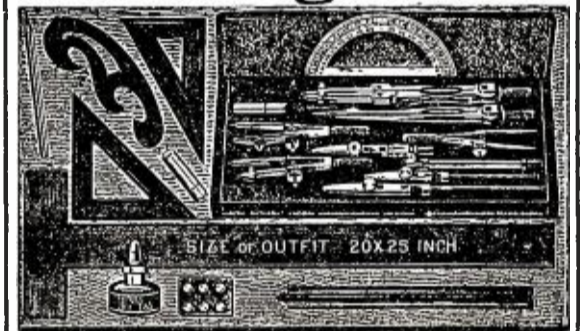

Complete set of drawing instruments in a handsome high class, plush lined folding case. They are regular draftsman's working instruments. They are absolutely free on this offer. Write for full information.

\$3600 a Year!

There is an urgent demand for skilled draftsmen. Companies are (posting calls every day) for men to fill positions paying \$3600 a year. Get my free new book "Successful Draftsmanship" and the great special offer I am making. Write today. A letter or post card will do. Act NOW.

CHIEF DRAFTSMAN DOBE, Dept. C-594 4001 Broadway, Chicago, Ill.

Q. S. A.

ANTENNA WIRE

19 strands No. 27 Tinned Silicon Bronze.
⅓ greater efficiency over stranded and ⅔ over solid copper. Greater signal and tensile strength.

Non-corrosive

100 ft. Coil.....	\$1.50
150 " ".....	2.25
200 " ".....	3.00
250 " ".....	3.50
300 " ".....	4.00

Postage paid in U. S. A.

MAXUM RADIO COMPANY
5837 Woodland Ave. PHILADELPHIA, PA.
Send for FREE catalog of Radio Supplies.

Newark Wireless Exchange

We carry all makes of Wireless Apparatus

Send 10 cents for catalogue

87 Halsey St.

Newark, N. J.

absorption of the second ship would not reduce the strength of the signals received by the first.

NICKEL IN THE SLOT RADIO-PHONES

Reports are circulating of the organization of a company for the manufacture of "nickel in the slot" radiophone receivers. These are expected to find a ready sale in drug stores, confectioners and ice cream parlors, pool rooms and many other places where people are wont to gather. The service will be selective in that baseball, market reports or music can be had by merely dropping a nickel at the right time for any of these sections of the broadcasting program.

TWO NEWSPAPERS BECOME "BIG STATION" BROADCASTERS

The Fort Worth *Star-Telegram* and the Omaha *Bee* have announced their intention of installing major broadcasting stations.

LONG RANGE RADIOPHONES

The new 1,000 mile broadcasting station of the Gimbel Department Store at Milwaukee is being heard by many Chicagoans. The Detroit *Free Press* station also is picked up nightly.

RADIO IN LINCOLN PARK

A permanent platform will be erected in Lincoln Park, Chicago, so that public radio demonstrations can be given every Saturday during the summer.

250,000 SETS IN THE MIDDLE WEST

Late figures on wireless sets now in use in the Middle West are approximated at 250,000.

SERVICE DEPARTMENT NOW IN VOGUE

Already a change is noticeable in the relations between manufacturers and dealers and the public. Radio seems to have settled down to a steady business in Chicago, and now dealers and manufacturers are offering service in much the same way that telephone subscribers and automobile owners demand. Manufacturers have service departments and dealers are quoting prices for installation and two or three months' service. From this it may be inferred the radiophone industry will be a utility like other public utilities.

DOUGLAS FAIRBANKS RADIO REPORTER

Douglas Fairbanks, movie star, was radio reporter at the thirteenth annual convention of the Rotary Clubs of the World, recently held at Los Angeles. Each evening "Doug" wrote 1,000 words, covering the happenings of the convention, and this was broadcasted by all Pacific Coast stations to other central radio points throughout the United States, when it was again distributed to the public by radiophone and the newspapers. Navy stations on both the Atlantic and the Pacific sent the stories to the twenty-two foreign countries where there are Rotary Clubs.

L. FALCONI AWARDED HOOVER CUP

Louis Falconi, of Roswell, N. M., was awarded a silver cup donated by Herbert Hoover for construction of the most efficient amateur wireless station in 1921. Falconi's station has been heard in every state of the Union but Maine.

Built By Rheostat Builders

Panel mounting.
 Pointer indicating.
 Positive travel stops.
 Fully nickeled finish.
 Single turn contact.
 Multi-step control.
 Adjustable contact fingers.
 Full off and full on positions.
 Coned knobs of genuine Thermoplax.

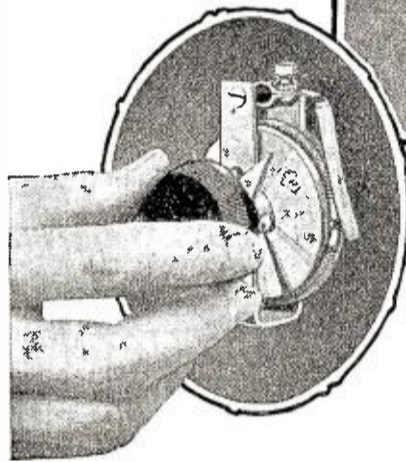
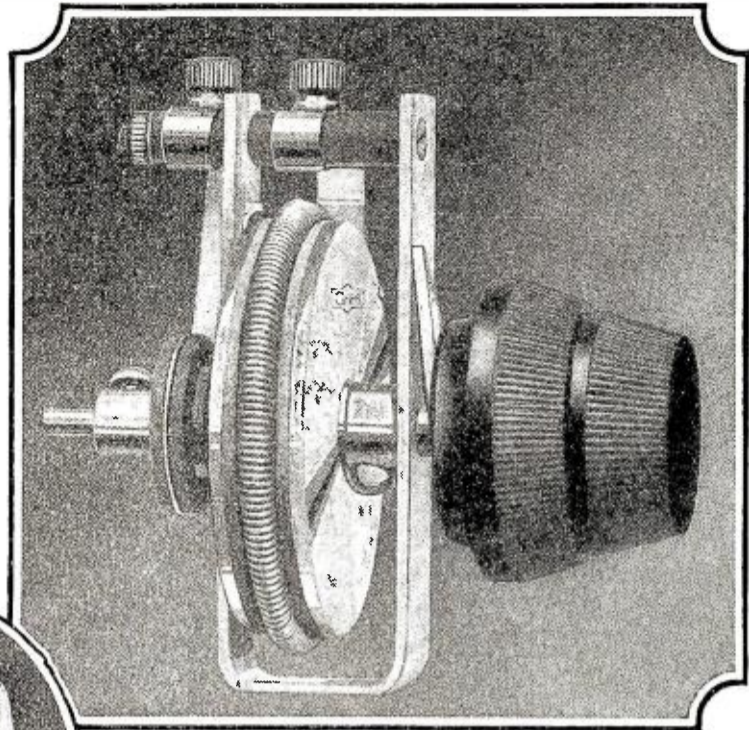

Cone-shaped knobs of genuine C-H Thermoplax render operation easy and untiring.

SINCE the nineteenth century Cutler-Hammer have been large builders of quality rheostatic control apparatus. Every purpose for which rheostats may be used—motor control, light dimming, battery charging, etc.—has been properly cared for by C-H equipment. The new vacuum tube rheostat incorporates this thirty years of specialized experience in an instrument in which proper design is a necessity.

FOR BETTER RADIO RECEPTION

IT has been shown conclusively that maximum detector action is possible only with extremely close adjustment of the filament voltage. For this, type 11601-H1 rheostat with vernier is ideal, allowing a stepless variation of resistance from zero to four ohms, with a current capacity of one ampere. The type 11601-H2 is excellent for the control of amplifier tubes in which a more rapid adjustment is desirable and fine control unnecessary.

The "full off" position of both types makes unnecessary additional switches in the control circuits. The "full on" position places the entire battery potential at the tube terminals when needed.

Type 11061-H1, with vernier...\$1.50
 Type 11061-H2, without vernier. 1.00

If you cannot obtain C-H rheostats from your local dealer, order direct from factory, enclosing 10c. additional to cover carriage.

THE CUTLER-HAMMER MFG. CO.
 MILWAUKEE WISCONSIN



VACUUM TUBE RHEOSTATS

RADIO ANTENNA TOWERS

Simple. Sturdy. Easy to erect. Built of galvanized steel. Will last for years. 100 ft. high or less. Fitted to take pipe mast at top. Immediate shipment. Write TODAY for prices.

Radio Department
STOVER MFG. & ENGINE CO.
 FREEPORT, ILLINOIS

The Condenser With a Conscience

The most rigidly constructed Variable Condenser. Securely balanced. Uniform variation of capacity. No leakage. Fully guaranteed.

11-Plate, Cap. .00025 + M.F. . . \$2.35
 23- " " .0005 + M.F. . . \$2.85
 43- " " .001 + M.F. . . \$3.60

MOUNTED CRYSTALS
 Guaranteed 100% Sensitive. 35c each
 We ship post-paid upon receipt of price

Standard Radio Products Co., Manufacturers
 207 Fulton Street, New York

R RIGGS R RECTIFIER

\$12.50

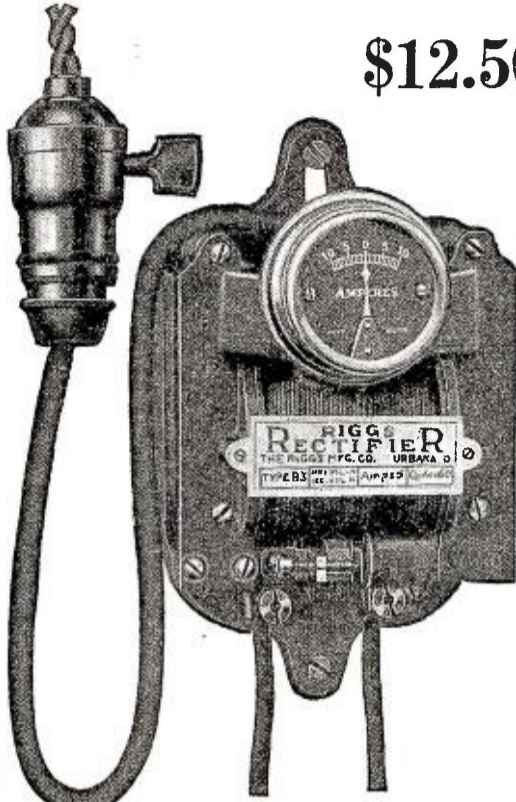

P. P. anywhere in the U. S.

CHEAPEST, BEST AND MOST EFFICIENT ON THE MARKET, ONLY ONE ADJUSTMENT.

We guarantee the type B to please you. Not only to do all we claim for it, but to please you. If you don't like it, we will take it back and return your money.

THE RIGGS MFG. CO.
URBANA, OHIO.

Everett, Wash. Hamilton, Ont., Canada

Write for Descriptive Circular A3



RADIO WEBBING FOR HEADPIECES

A special webbing woven Tubular for the metal insert. Furnished by the yard, or pieces cut and tipped both ends. Call on our nearest branch.

THE RUSSELL MFG. CO.
Middletown, Conn.

Branch Offices:
NEW YORK CITY:
349 Broadway
DETROIT, MICH.:
523 Jefferson Ave. East
CHICAGO, ILL.:
1458 Michigan Ave.
ATLANTA, GA.:
60 South Forsyth St.

Wireless Operators Wanted

LEARN WIRELESS AT HOME IN SPARE TIME

The demand for experts exceeds supply. Pays big salaries, \$125 to \$250 a month to \$10,000 a year. Our home course will make you an expert operator in shortest possible time. Instruction by radio experts. We give you Best Theory, Text-Books, and Two Instruments Free, the wonderful Omnigraph and

FREE VACUUM TUBE Wireless Phone AND CODE SET

Given Free with Professional Course.

Special Low Cost, Quick, Simple

AMATEUR WIRELESS COURSE

Qualifies For Amateur License

Write for booklet "How to become a Wireless Operator."

NEW YORK WIRELESS INSTITUTE
154-V Nassau St. New York City

BLIND MAN GETS LICENSE

Harold M. Leffingwell, 23 years old, 1010 North Pine Street, Lansing, Mich., who has been blind since birth, recently passed the Federal first grade amateur radio examinations with a mark of 93.

POLICE CARS TO BE EQUIPPED WITH RADIO

An appropriation of \$68,000 has been asked by George E. Carlson, Commissioner of Electricity of Chicago, to install in police cars radio equipment. Experiments in the use of radio for the transmission of police messages have proved a complete success. Automobiles used by the Detective Bureau will be equipped with both sending and receiving sets. Chief of Police Fitzmorris is of the opinion that this step will prove an important factor in arresting criminals.

Another angle of the police radio service is a pocket miniature wireless telephone. No matter where he happens to be, the patrolman is always in touch with Central Office. William G. Keith, superintendent of the City Department of Electricity, has been experimenting with the pocket wireless and claims that presently every man on the force will be in touch with headquarters. The marvelous little instruments are not exactly new. They were tried out in the war. The Intelligence Department has been using them and England has been experimenting with them. A policeman will be able to receive a message, but not send one. He can hold the instrument in his hand, place a receiver to his ear, and with the antenna in the lining of his coat hear a warning from headquarters of a holdup, a murder, or a riot call. Then he can hurry to the nearest station and learn further details.

Detroit policemen also are to be equipped with small, portable wireless sets, weighing about two pounds or less. Superintendent William L. Potts, of the Police Signal Bureau of Detroit, has had the matter up with Commissioner James Inches, and soon every patrolman will be constantly in touch with headquarters and precinct stations for any emergency that may arise. Superintendent Potts is the inventor of a small receiving apparatus admirably suited to the purpose.

A sixty-foot pole will be erected on the new police station now under construction and police officials will be able to get in touch with police headquarters of other cities throughout the United States.

From the foregoing it will be readily seen that not only can criminals be caught after a crime has been committed, by the use of radio, but another method to fight vice and crime in Chicago is a plan by Rev. Williamson, Mayor Thompson's vice specialist, to stir the consciousness of the public to the fact that law enforcement is a duty of the private citizen as well as that of the regularly constituted officials. Dr. Williamson is giving talks from the broadcasting stations on methods to prevent or ameliorate crime conditions.

MAKING THE RADIO BRING IN BUSINESS

Market reports are vital items in the life of the farmer, and knowing this, the Department of Agriculture has made every effort to reach him and aid him in keeping in touch with sources of this information. Therefore he was quick to seize upon the radio as a means of obtaining these reports.

Market reports are now being broadcasted with the aid of the Department of Agriculture and it is estimated that fully one-sixth of recent installations of receiving sets have been made by farmers for the purpose of receiving these reports.

This gave the Jansen Lumber Co., of Jansen, Neb., an idea. The company installed a radio room, arranged for the daily weather reports, and the live stock and grain market reports. Then it advertised through the

If **QUALITY** counts bear in mind that **ACE** equipment speaks for itself. An Ace type TRU Concert Receptor can be placed in your parlor, and is in a class with your piano or finest phonograph.



\$50
\$50

Licensed under Armstrong Patent
No. 1,113,149

For electrical efficiency we claim our TRU to be equal or superior to any similar equipment now on the market.

A very important point to be considered in purchasing a Concert Receiver is the proposed change of wave lengths of broadcasting stations. The majority of Radio Receivers now on the market would be worthless should this change be effected. Our receiver is arranged for immediate adaption to this change by even a most inexperienced person.

Better investigate—we have literature for the asking.

THE PRECISION EQUIPMENT CO.
2437-39 Gilbert Ave., Cincinnati, Ohio

RADIO CATALOG

Our New Perpetual Loose Leaf Catalog and Reference Book is ready for distribution. Send 25c and your name will be put on our list. You will receive the catalog now and all new sheets and diagrams as they are issued.

Positively No Stamps Accepted
Ask for Reel Easy Products
I. R. Nelson Company
BOND STREET, NEWARK, N. J.
Radiophone Station W-A-A-M

High School Course in 2 Years

You can complete this simplified High School Course at home in side of two years. Meets all requirements for entrance to college and the leading professions. This and thirty-six other practical courses are described in our Free Bulletin. Send for it TODAY.

AMERICAN SCHOOL
Dept. HC-85, Drexel Ave. & 58th St. CHICAGO

MAGNET 1/2 LB. SPOOLS WIRE

No.	Enaml.	S.C.C.	D.C.C.	S.S.C.	D.S.C.	
18	.32	.40	.45	.70	.80	1 lb
20	.35	.45	.48	.72	.84	1/2 lb
22	.40	.52	.56	.74	.90	SPOOLS
24	.44	.56	.60	.78	1.05	46%
26	.48	.60	.66	.80	1.15	less.
28	.53	.66	.78	1.00	1.20	
30	.56	.88	.96	1.14	1.50	Other sizes at proportionate prices.

1 lb. spool add 90%
No. C. O. D. Immediate delivery P.P. Free in U.S.A. Circular for stamps.

AMERICAN RADIO COMPANY
Box 133 Baltimore, Md.

CARDBOARD TUBING

	Seamless—Grey	Per Inch or Fraction	Per Ft.
2 1/2, 3 and 3 1/2 in. O. D.		3 1/2 c.	30c
4, 4 1/2 and 4 3/4 in. O. D.		4 c.	35c
5 in. Outside Diameter		4 1/2 c.	42c
5 1/2 and 6 in. O. D.		5 c.	50c

Postage Extra—Shipping Weight, 1 lb. per ft.

Dealers Write for Discounts
MICHIGAN RADIO CO.
2173 Hillger Ave. Detroit, Mich.

WISCONSIN AMATEURS!

Westinghouse	Magnavox
Remler	Brandes
Murdock	Baldwin
Rhamstine	Western Electric
A. P. and Cunningham Tubes	
Willard Radio Batteries	
Eveready Batteries, Panels, Wire, etc.	
Order from any Standard Catalogue	

CHAS. A. HONOLD CO., Sheboygan, Wis.

local papers and by circular that the radio room was open to all farmer visitors to the town and these reports were available there free at all times.

The market reports are received hourly and are posted on a blackboard which stands in the company's office.

The farmers began to take interest at once and in a very few days telephone calls were being received from farmers who could not get in during the day. Needless to say that any farmer who is going to build a barn or a fence or a porch will think first of the Jansen Lumber Co. when he buys his lumber. If one good turn deserves another, the farmer surely feels that this friendly, free service deserves a return by way of trade. At any rate farmers' business has been picking up with that company since the installation.

The set is a simple one, costing about \$65 and it works perfectly, the manager says, receiving messages from two to three hundred miles away.

PORTO RICO AND SOUTH CAROLINA GET FIRST BROADCASTING STATIONS

The Department of Commerce issued 13 more broadcasting licenses during the past week, including one to a radio school in Porto Rico and one to a radio shop in Charleston, S. C., the first stations on the Island and in the State. This leaves but five States without one or more broadcasting stations.

The 13 new stations licensed bring the total list of broadcasters in the United States and territories to 361.

SUPPLEMENTAL LIST OF COMMERCIAL BROADCASTING STATIONS LICENSED DURING WEEK ENDING JUNE 24

- WFAY—Daniels Radio Supply Co., Independence, Kans.
- KFAC—Glendale Daily Press, Glendale, Cal.
- WFAX—Arthur L. Kent, Binghamton, N. Y.
- WFAU—Edwin C. Lewis, Inc., Boston, Mass.
- WFAW—Miami Daily Metropolis, Miami, Fla.
- WFAZ—South Carolina Radio Shop, Charleston, S. C.
- WFAV—University of Nebraska, Lincoln, Neb.
- WGAF—Goller Radio Service, Tulsa, Okla.
- WAAB—Valdemar Jensen, New Orleans, La.
- KFAD—McArthur Bros. Mercantile Co., Phoenix, Ariz.
- WGAC—Orpheum Radio Stores Co., Brooklyn, N. Y.
- WGAD—Spanish-American School of Radio Telegraphy, Ensonada, P. R.
- KFAE—State College of Washington, Pullman, Wash.

FIFTY-ONE STATIONS AID IN BROADCASTING MARKET REPORTS

Since the first national broadcasting of official agricultural news by radio telephone in December, 1920, the national crop and market reports of the Department of Agriculture have covered more and more territory and increased in value to the farmer as well as the public in general, until today there are 45 governmental and private broadcasting stations handling this form of news. Six applications, one each in Fort Worth, Nashville, Jacksonville, Cincinnati, St. Louis and Hutchinson, Minn., for broadcasting crop and market reports have just been approved, bringing the total stations to 51, while 29 other applications in several States are awaiting action.

The Bureau of Markets has official market stations at Boston, New York, Philadelphia, Pittsburgh, Cincinnati, Chicago, Minneapolis, St. Louis, Kansas City and Omaha,

RADIO CABINETS of Genuine

MAHOOGANY

—last longer, look better and give the greatest amount of satisfactory service. Properly dried Mahogany is easier to work, checks less and warps less than any other cabinet wood.

—and, in addition to its practical utility, its beauty commends it to the amateur operator who takes pride in his outfit.

Takes a fine polish—can be varnished or hand-rubbed with shellac and oil and its beautiful grain, pattern and color form a restful note in any interior—whether it's your drawing room, den or sleeping quarters.

—and the cost of Mahogany is little, if any, in excess of other cabinet woods.

Write us for a list of the Manufacturers and Dealers in Mahogany.

MAHOOGANY ASSOCIATION, INC.
St. James Building - 1133 Broadway
New York City

after all—there's nothing like

MAHOOGANY

RADIO DEALERS! United Variable Condensers



A special contract with the manufacturer of the United Variable Condenser permits us to quote unusually low prices. Order from this ad—or if you are a dealer write for discounts today.

Base and top made of best quality bakelite, nickel-plated hardware, aluminum plates.

- 43 Plate (as cut)..... \$4.00
- 23 " (" ")..... 3.25
- 11 " (" ")..... 3.25

All sizes accurate in capacity

APEX RADIO COMPANY, Inc.
1105 W. 69th St., Chicago, Ill.

OFFICIAL
RADIO BROADCAST MAP
(In Two Colors) 10 Cents Postpaid
Experimenter Pub. Co., 53 Park Place, New York

For Easy Tuning Use

G-W Sliders

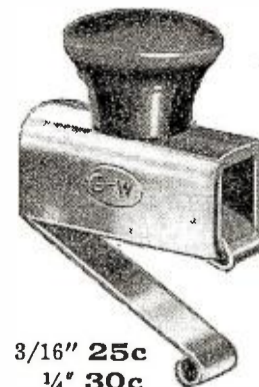

Perfect contacts at every point. Right pressure all the time. Tunes on a single wire. Slides easily. Curved surface contact never sticks. Will not cut or damage wire. Works better, wears better, looks better than any substitute. One price all over the country.

- 3/16" 25c
- 1/4" 30c

ASK FOR G-W RODS AND G-W STRAIN INSULATORS

Distributors Write

Gehman & Weinert

42 WALNUT STREET NEWARK, N. J.

RADIO PARTS

To Manufacturers of Radio Instruments and Dealers in Instruments and Radio Supplies

WE make a specialty of fine screw machine parts for radio apparatus and have on hand for prompt shipment Binding Posts (sizes 6-32 and 8-32).

We are ready to make promptly to specifications screw machine parts for

- | | |
|---------------------|---------------------|
| Switch Knobs | Switch Points |
| Rheostats | V. T. Sockets |
| Variable Condensers | Lightning Arresters |
| Detectors | Head Receivers |
| Coil Mountings | Jacks |
| | Plugs |

or any necessary screw machine parts to any dimension and to meet any requirements.

All H. M. S. products are of supreme accuracy and are interchangeable. Each part is milled from the solid bar—highly finished and plated and ready for assembly.

Specifications are invited.

Our service is as prompt as our product is dependable.

HARTFORD MACHINE SCREW CO.

HARTFORD, CONN.

New York Office: 409 Broome St.

Telephone Canal 5280

as well as 73 branch offices in 46 large market centers, 16 of which are directly connected with the Washington office by direct wire, all securing vital agricultural news. At least 15,000 individuals, firms and railroads cooperate in gathering data on fruits, vegetables, grain and live stocks for daily use. Fifteen agricultural colleges are assisting in the broadcasting. Besides the telephone broadcast, the Bureau of Markets, through the cooperation of the Navy Communications Service, sends out daily market reports in code from high powered stations at Arlington and at the Great Lakes Training Station.

BELVIDERE, ILLINOIS, A RADIO TOWN

Manufacturing plants of Belvidere, Ill., are busy filling orders for radio sets in such numbers that the midwestern town is likely to become the country's leading radio center, just like Detroit leading in the automobile industry. Manufacturers, banks, commercial organizations, and in fact the whole population, are particularly interested in the radio boom. All parts of radio equipment are made in Belvidere plants.

SPARK SETS FOR SALE

The Shipping Board is offering for sale 78 complete radio spark sets formerly used on its wooden war fleet, and estimated at a total valuation of \$250,000. The sets are 1/2, 1 and 2 KW. sets and include transmitters, batteries and generators. They are located at Norfolk, Va., where they may be examined by applying to B. N. Rock, 1025 Water Street, and purchased at private competitive sale.

RAPID GROWTH OF GERMAN TRANSATLANTIC RADIO SERVICE

By the Berlin Correspondent of RADIO NEWS

When the German Transradio service, in August, 1919, on the resumption of international economic relations with Germany, was inaugurated, the monthly average only worked out at about 100,000 words. However, in June, 1921, a monthly total of 550,000 words was recorded, while the million mark was first exceeded in January, last. According to returns covering the first quarter year, 1922, this steady growth has been continuing, a total of more than 1,100,000 words having been exchanged from the Nauen and Eilvese radio stations in March and a record figure of 50,000 words on March 16. Figures relating to the second quarter year are, of course, not yet available.

This rapid and steady growth is all the more remarkable inasmuch as it strikingly reflects the corresponding growth of international business. A recent improvement in the wireless service between Germany and the United States enables radiograms sent out from the center of Berlin to be, at that very moment, recorded in the heart of New York, and vice versa. This is made possible by providing a remote control by means of which the Nauen and Eilvese radio stations are operated direct from Berlin. In fact, the whole Berlin radio business is now centered at the Transradio Office located at the Oranienburgerstrasse Post Office.

NATIONAL RADIO CLUB ORGANIZING

PROPOSES TO WELD NATION'S ARMY OF RADIO ENTHUSIASTS INTO ONE COMPACT BODY

Pittsburgh, Pa., is the scene of the organization of a club that seems destined to play a big part in the future of radio. The work of enrolling members is already well under way and articles of incorporation have been filed along with application for a charter.

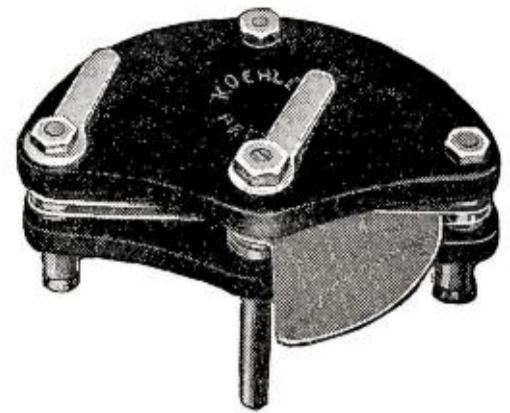

3 PLATE VERNIER VARIABLE CONDENSER

Heavy aluminum plates, all parts of brass, nickel plated, molded composition ends.

Well made and separately inspected and tested. The best you can offer your customers.

Typical of our extensive line, which includes the products of sixteen of the largest manufacturers. Immediate delivery on all orders. Interesting proposition.

List, \$1.50

Attractive Discounts

Send for Samples and List of Line

WHOLESALE RADIO EQUIPMENT CO.
22 WILLIAM ST., NEWARK, N. J.

A, B, C of Radio Illustrated and Explained



RADIO SIMPLIFIED

What It Is. How to Build and Operate the Apparatus By KENDALL and KOEHLER Licensed Operator and Radio Instructor

RADIO MADE PLAIN
Describes in simple non-technical language the principles and NEW DEVELOPMENTS of Radio; the latest and most efficient HOOK-UPS; VACUUM TUBES; LOOSE COUPLERS; VARIO-COUPPLERS; VARIOMETERS, and everything necessary for those who aim to GET THE BEST RESULTS in building or operating a Radio outfit.

\$1

Illustrated with Diagrams & Photos. Cloth. 224 pages. Table of Contents on request.

JOHN C. WINSTON CO., J-24 Winston Bldg., Philadelphia

WRIST WATCH AND 2 FINE STRAPS



Nickel Case 7-Jewel Lever

This elegant men's Wrist Watch was never sold for less than \$15.00. The sturdily-built, high-grade lever movement will keep accurate time. Has luminous dial and hands to show time in the dark. You can have it in nickel or gun metal case. 7 Jewels, \$4.95; 10 Jewels, \$5.75; Sterling silver, \$6.95. Extra thin Model Gents' Watch, Nickel, High-grade 7-Jewel lever movement, \$4.95, or guaranteed 10-year gold filled, \$7.95. Free: Fine gold filled Waldemar chain.

RADIUM DIAL AND HANDS \$4.95

UNBREAKABLE GLASS VALUE \$15.00

SATISFACTION GUARANTEED OR MONEY REFUNDED

25c brings any of these watches with a written guarantee to you, pay balance to postman on arrival. If you are not entirely pleased after 10 days' trial, return watch and we will exchange it or refund your money. Write us today. Illustrated Watch Booklet Mailed Free.

Uneeda Watch Co., Dept. RA
217 Eighth Ave., New York City

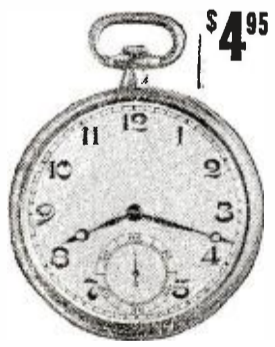

Vacuum Tube Detector, \$5.50

Including complete cabinet with all instruments wired ready for use

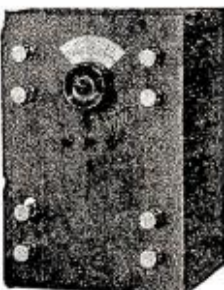

Detector and Two Stage Amplifier

\$22.50

With transformers and all other instruments in cabinet ready for operation. This equipment is of high quality and distances as great as 3000 miles have been obtained with ease.

Batteries and Tubes Extra

2000 Ohm Receivers, \$5.00

Superior Crystal Receiving Set, \$4.75

Attractive dealers' proposition

Steinmetz Wireless Mfg. Co., Inc., 5706 Penn Ave., Pittsburgh, Pa.

NEW ORLEANS RADIO

APPARATUS and SUPPLIES

ROSE RADIO SUPPLY

604 Gravier St., New Orleans, La.

Send 10c for Latest Catalog

CRYSTAL DETECTORS

Mounted or Unmounted
Immediate Delivery Wholesale Only

MIDWEST MINERAL CO.

447 Greenway Terrace, Kansas City, Mo.

International Radio Corporation

DEALERS—Write for Prices

We manufacture receiving sets, variable condensers, variocouplers, variometers, sockets, rheostats and parts for assemble of radio receiving apparatus.

Dept. A, 42 Branford Pl., Newark, N. J.

TELEGRAPHY

(Morse and Wireless) and RAILWAY ACCOUNTING taught thoroughly. Big salaries; great opportunities. Oldest, largest school. Endorsed by Telegraph, Railway, Radio, and Government officials. Expenses low—opportunities to earn large portion. Catalog free.

DODGE'S INSTITUTE, D Street, Valparaiso, Ind.

While one of this club's fundamental purposes is to promote and finance the installation of radio equipment in hospitals, it will also use its influence to keep the broadcasting art on its present high plane; enlarge musical and educational radio programs; keep all members informed regarding developments, improvements and news of interest regarding radio; answer, without charge, all technical questions asked by members; receive and file articles written by members for reference; lend the moral support and influence of the club to those agencies endeavoring to eliminate the confusion of signals; promote fraternity and good fellowship among members with the aid of a distinctive official button and card of membership.

The organization committee includes Harold B. Coe of New York City, Charles W. Payne of Philadelphia, F. R. McCray of Los Angeles, Otto J. Palm of Cincinnati, R. Gordon Craig, Ray Mansmann, and Francis G. Albertson of Pittsburgh, all radio enthusiasts who are sparing no effort to promote the interests of radio transmission.

Although the National Radio Club has been assured the hearty cooperation of the large manufacturers it will maintain a strictly neutral attitude in all matters of equipment and its officers and directors will be selected from radio enthusiasts not engaged in making or selling radio apparatus.

A nominal membership fee of two dollars will be paid by applicants who will have issued to them a membership card and club button. Among the possibilities envisioned for the future by the club directors are courses of instruction designed to enable members to pass examinations for operator's license.

Interested persons can get in touch with the club by writing to Francis G. Albertson, Secretary, 419 Fulton Bldg., Pittsburgh, Pa.

RADIO AT BUSINESS MEN'S CONVENTIONS

A novel feature will be added to two conventions of business men on July 11th and 12th, if the present plans of the Department of Commerce are carried through. The New England Shoe and Leather Association Exposition and an import and export exposition are to be furnished by radio with the latest news of foreign markets and trade opportunities, through the Arlington Radio Station. This information, received from abroad by the Department of Commerce, will be broadcasted from Arlington (NAA) at 8 p. m., on July 11th and 12th, on a wave length of 2,650 meters.

A NEW LOUD TALKER HORN

A WONDERFUL discovery was recently made by Father Odenbach, director of St. Ignatius College observatory, when a triton shell of porcelain was tried out with a Magnavox to produce a sounding horn effect. Popular music was received with the utmost clearness and fine detail through this device.

This ordinary shell, which may be found resting harmlessly on mantel-pieces and drawing room tables in thousands of homes, used purely for decorative purposes, not only greatly intensifies music and speech when the tip is ground off and the shell is attached to a Magnavox or receiver on a radio receiving set, but performs as well a most remarkable feat of bringing out every sound to the smallest detail.

A musical instrument perfectly tuned and played well will offer remarkable music through this horn, but let the instrument be the least bit out of tune and it will at once become evident. So sensitive is this device,—termed an Analyzer by Father Odenbach—that the faintest squeaking noise emitted from a violin as the result of the application of too much rosin on the bow, hardly noticeable to the human ear, is nevertheless plainly brought out by the Analyzer.

BRISTOL LOUD SPEAKER

TRADE MARK

AUDIOPHONE

PATENTS PENDING DESIGN PATENT PENDING

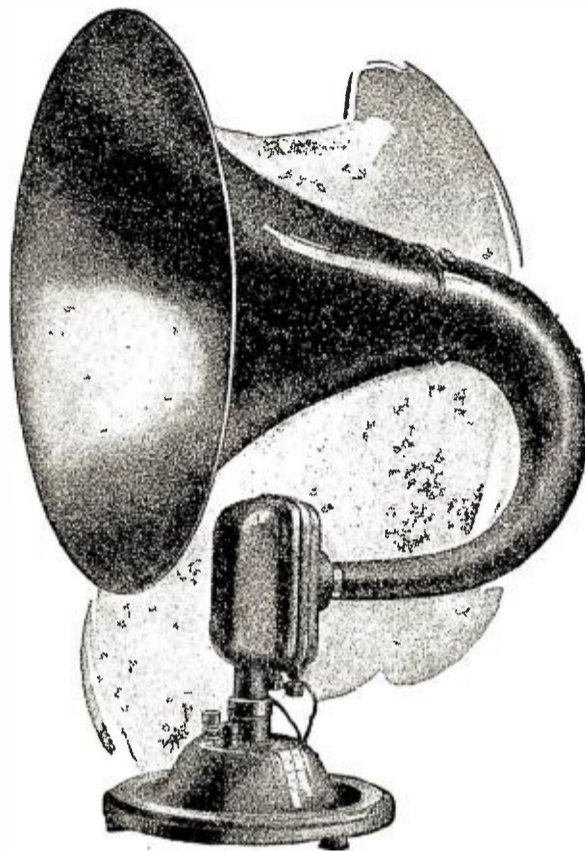

For Radio Receiving Sets, on two or three stages of amplification. NO DISTORTION of Music and Speech. No Batteries required. A marvel of simplicity. Only one moving unit, comprising a diaphragm and an armature attached directly to it. Horn 15 inches in diameter. Handsome design, bronze finish.

PRICE, Complete - \$40.00

Made and Sold by

THE BRISTOL COMPANY

WATERBURY, CONN.

- | | | | |
|----------------------------------|---------------------------------------|-------------------------------------|------------------------------|
| OLD SOUTH BLDG.
BOSTON, MASS. | 114 LIBERTY STREET
NEW YORK, N Y. | FRICK BLDG.
PITTSBURGH, PA. | BOOK BLDG.
DETROIT, MICH. |
| MONADNOCK BLDG.
CHICAGO, ILL. | BOATMANS BANK BLDG.
ST. LOUIS, MO. | RIALTO BLDG.
SAN FRANCISCO, CAL. | |
| WIDENER BLDG., PHILADELPHIA, PA. | | | |

WANTED

In Every Radio Club Everywhere

A Representative to secure yearly subscriptions to **Science and Invention** and **Radio News**.

The demand for these magazines will be greater this fall and winter than ever before.

Every member of your club will want them both.

We wish a special representative in every club, to secure these subscriptions for us.

We will pay a most liberal commission—will send you sample magazines, subscription blanks, etc.

This is an opportunity to make some easy money in your spare time—write today to

Mr. C. J. Wolfe, EXPERIMENTER PUB. CO.
53 Park Place, New York

The New Improved Lightning Arrester

ESSEX

Simplest, easiest to install, safest. Yet it costs less than most arresters.

At All Good Dealers **\$1.50**

Ask for **ESSEX** Products
Tuning Coils, Double Slider, \$3
Mounted Crystals, 25c
Fixed Condensers .001 MFD, 70c

Dealers Write for Discounts



ESSEX MFG. CO.

115 MULBERRY ST.
NEWARK, N. J.

HEAD SETS THAT GIVE SERVICE

WESTERN ELECTRIC HEAD SETS
 tested and designed by experts. Very light and sensitive.

\$15.
 Brown Phones
\$16.
 Selbt Phones
\$14.
 Auth Phones
\$8.
 Federal Phones
\$8.



SPECIAL MOTOR GENERATOR
 For charging storage batteries—110 Volts A. C. or D. C. Generator; Output—8 to 10 volts. 8 Amperes D. C. **\$40**

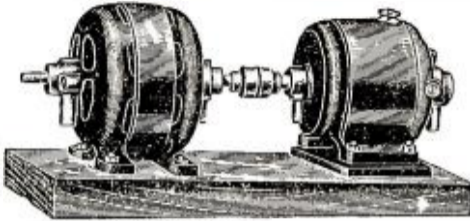

AETACO HEAVY ROTARY SWITCH
 with special bearing and Bakelite Knob
75c each

Lightning Switches
 600 Volt—100 Amp.
\$3.60

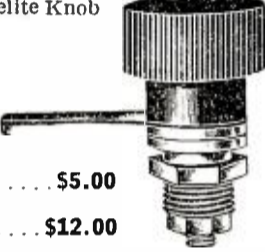

Arkay Horns **\$5.00**
King Am-plitone **\$12.00**

CABINETS—All Sizes and Prices
 Everything for Radio—Send 10c for Catalog N-8
 ---DEALERS' INQUIRIES INVITED---

AMER. ELECTRO TECHNICAL APPLIANCE CO.
 227-229-235 Fulton St. **NEW YORK**

THE McTIGHE STORAGE B BATTERY

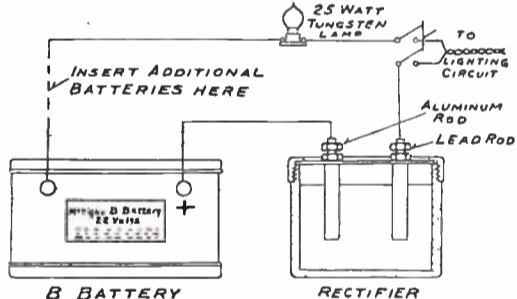

The McTighe Storage "B" Battery is of the alkaline type, is the most satisfactory source of plate potential, and can be charged from your lighting circuit for less than one cent. Can also be charged from farm lighting systems.

In ordinary service a one-hour charge will last for several weeks.

The Battery is furnished in a 24 volt unit in an attractive case.

It is noiseless and cannot be injured by accidental short circuit, overcharging or by standing idle.

Descriptive leaflet on request

PRICES

Battery **\$4.00**
 Rectifier **1.50**
 Rubber Filler **.25**

F.O.B. Irwin, Pa.

ECONOMIC APPLIANCE CO.
 Successors to McTighe Battery Co.,
 Water Street - - IRWIN, PA.

STORAGE BATTERIES and RECTIFIERS

AMERICAN BATTERY CO.
 2056 N. Racine Avenue
 Established 1889 **CHICAGO**

Jazz would soon cause its own destruction if received through radio outfits employing this horn, according to Father Odenbach. Since it brings out every possible sound, jazz when received and analyzed through the shell becomes a medley of noises which may be summarized at one-third dissonance, one-third poor tuning and the rest insane noises.

The idea for the use of the triton shell as a sounding horn was prompted by the close resemblance it bears to the human ear. It contains four spiral layers—a sort of winding staircase—commencing at the tip and broadening out at the shell. The vibration of the shell and the winding aperture are the elements which produce the sounding horn and analyzing effects.

To employ a shell to act as a sounding horn one needs only to grind off the tip to form an opening of about one-half inch in diameter. The next step is to chisel out the interior at the aperture formed, then to continue chiseling out and opening up the spiral layers of about the size of a fore-finger. That accomplished, mount the shell on a small block of wood made ready to hold the shell in place and having a bore through it to permit the sound to pass into the shell. The shell may be made to rest firmly on the block by applying some sealing-wax at the place where the shell fits into the block. Finally, attach a rubber hose from the Magnavox to the bore in the block; garden hose will do for this purpose.

There is a distinct object in recommending the use of a rubber pipe between Magnavox or receiver and the horn. It has been found that with the use of the rubber pipe a much softer and clearer tone may be had and it is also free from foreign sounds, especially as the case may be where a metal tube instead of a rubber hose is employed.

The following types of shells will prove excellent sounding horns: Triton, Murex, Strombus, Pteroceras, Buccinum.

In selecting a shell, one should be procured which has a wide and clear opening at the mouth; the wider the opening the better. A shell about the size of a medium-sized coconut will do nicely for receiving radio concerts in the home.

A SIMPLE VERNIER

One of the most important things confronting the amateur in receiving long distance phone is the micrometer adjustment of the rheostat. Anyone, however, having two tubes, may have his own vernier.

For example, we hear a broadcasting station, at 91° on the dial of the detector rheostat we hear his C. W. The amplifying tube gives the best amplification at 100°. If the detector tube is turned backward the least bit from 91°, the phone is lost; if it is turned up the least bit toward 91°, the C. W. is heard. We now know that the correct voltage of the detector tube lies between 90° and 91°. Set the rheostat of the amplifying tube at 75° and adjust the detector on the verge of the C. W. If the dial on the second tube is now moved slowly toward 100°, it will slightly decrease the current in the detector, thus making the phone audible and giving a vernier. If two separate filament batteries are used, this stunt will not work.

Contributed by **PAUL S. FOX.**

Fading and Old Man Static

By **A. F. VAN DYKE***

Many inquiries have been received lately by WGY, the General Electric Company radio broadcasting station at Schenectady, seeking light on static phenomena and fading. It is the purpose of this brief article to attempt to answer such inquiries with the

*Radio Engineer, General Electric Co.

Immediate Delivery

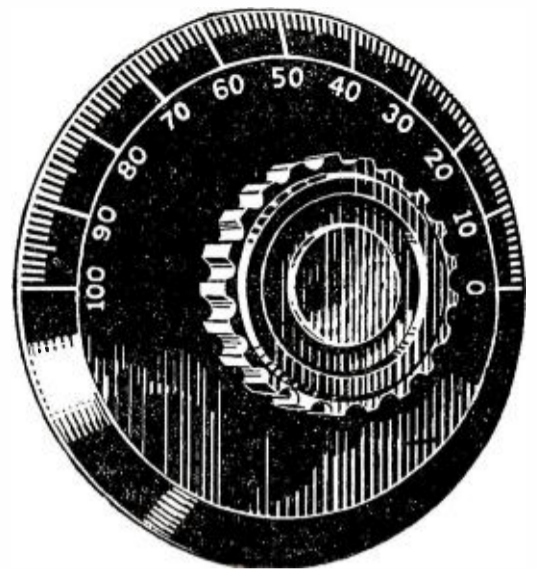

3" Dial moulded of Bakelite with inlaid white enamel markings. Brass insert, which may have 3/16 or 1/4 inch hole, is cast in dial proper, which insures perfect alignment.

OUR PRICES ARE EXCEPTIONALLY LOW

Dealers—write or wire for discounts

The R. F. Ehler Specialty Co.
 24 N. Canal Street - DAYTON, OHIO

AUTH

Supersensitive Phones
 2200 ohms, list price **\$8.00**

To get the best results from your set use AUTH Phones

VARIABLE CONDENSERS
 11-23-43 Plate
 List **\$2.75—\$3.25—\$4.00**

These are variable condensers that are highly efficient and exceedingly well made.

Dealers Write for Attractive Proposition!

RADIO DEPARTMENT OF
SIGNAL SYSTEMS SERVICE CO.
 1 E. 42d St., NEW YORK CITY

WE HAVE EVERYTHING
 A Complete Stock of
RADIO SUPPLIES
 Panels cut and drilled to your order.
 Free Technical Advice
 RADIO DEPT.
ELLIOTT ELECTRICAL SUPPLY CO.
 68 East 116th St. NEW YORK CITY
 HARLEM 8600

5 Master Keys



Only keys of their kind in existence—(patented.) Open and test thousands of different locks. Tell you instantly if your door or padlocks are burglar proof. Serve in emergencies, too. Thousands of sets in daily use among detectives, policemen, contractors, locksmiths, firemen, mechanics, travellers, home and hotel owners, etc. Give feeling of security and protection worth many times their cost. Novel key chain FREE. Send \$1 today. Agents Wanted. Mention if interested when ordering. Master Key Co., 134 Manhattan Block, Milwaukee, Wis.

Carter Radio Co.
 233 S. STATE STREET
 CHICAGO

New Design **TU-WAY** Plugs, Head Sets, Jacks
 Variable Condensers, Rheostats, V-T Sockets
 If your jobber does not carry our products, write us direct

understanding that the explanations are the ones which are believed to be nearest the truth, although they are not subject to rigid proof, in view of the fact that the questions which involve radio phenomena are not completely understood by scientists today.

First, let us consider what radio transmission is. We know that a radio sending station sends out from its antenna in all directions, a disturbance of electric forces. We cannot see or hear or otherwise observe with our senses just how this disturbance behaves, as we can with light waves and sound waves. We consider it quite natural that a stone wall stops the light beam from a searchlight, or that a bugle call can be heard much farther over water than through a forest, or that under certain air conditions on a desert the mirage phenomenon is observed; and to know what to expect in radio, we need only to remember that some things in space will stop, or reflect, or perhaps absorb the traveling radio waves, just as some other things in space stop or absorb or reflect light waves, or sound waves. We must not expect radio waves to travel out from a transmitting station, over some enormous distance to a receiving station, without encountering some obstacles somewhere in its path.

Substances which are obstructions to light or sound waves are not necessarily such to radio waves. For example, we know that radio waves pass through the walls of a house with only slight loss. But there is some substance in the space around the earth which does have effect upon radio waves. This substance is not uniformly distributed through space, but is present here and there, is continually changing location and magnitude, and consequently has very erratic effects on the passage of radio waves. The condition is quite similar to the use of a searchlight in a fog which might be varying rapidly in density or location or both. This radio fog is commonly supposed to be made of ionized air, that is, air which by some influence has become a partial conductor of electricity. Of course this radio fog never stands still and is changing from moment to moment under the influence of the complicated conditions of our atmosphere, and so the radio wave passing through space surely has an adventurous journey, because it meets electrically charged clouds, patches of ionized air, and perhaps other obstacles of which we know nothing.

It is a fact, often observed, that it is possible to work radio communication over much greater distances at night than in the day time. This may be explained by the effect of the sun upon the air, which causes ionization of it, and is most active in the daytime, and practically absent at night. The sun seems to be responsible without question, in view of the fact that very erratic results in long distance reception are always noticed at sunrise and sunset.

With the preceding statements in mind it should be clear that when one is receiving over long distances—several hundreds of miles—it is natural for the waves to come through strong at one moment, and to fade away considerably the next moment, as some obstacle to radio waves comes between the transmitter and receiver. This explains, too, why one transmitting station, of two or more which are being heard, may get weaker, while the others do not. For example, suppose a receiving station in Chicago is receiving from New York and also from San Francisco. A patch of radio fog might appear between Chicago and New York and weaken the New York signals, while the signals from San Francisco remained unchanged. Whenever in reception over a considerable distance one observes a variation in the intensity of the signals, it is most likely due to so-called "fading" caused by some obstruction to the traveling waves somewhere between the two stations, and not to any fault of the transmitting station itself. These effects are much more frequent in the summer than in the winter season,

TUSKA

Popular Radio Receiver

Type
224

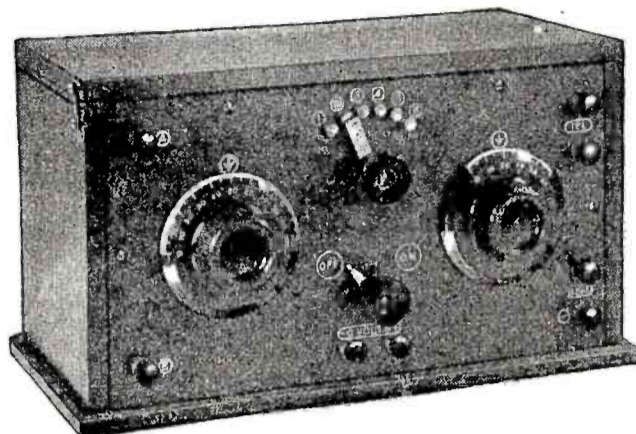

Price
\$35

Inspect this new Tuska Set at your dealers

The Type 224 Receiver is completely moulded. It is the ideal set for the beginner. Two knobs; one for wave length, the other for regeneration.

LICENSED UNDER ARMSTRONG PATENTS

Send 5 Cents for our New Catalog No. 3

The C. D. Tuska Company
24 Hoadley Place
Hartford, Conn.

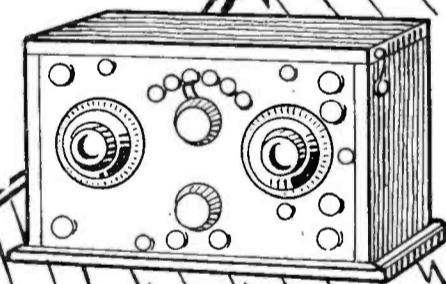

FREE FREE FREE

With every order amounting to \$1.00 or more, 7 nickel switch points, 2 switch stops.

Shipments upon receipt of order.

Magnet wire per 4-ounce spool, prepaid:

	Single Enamel	Double Cotton		Single Enamel	Double Cotton
No. 20	.29	.37	No. 24	.33	.44
No. 22	.31	.38	No. 26	.35	.50

Other sizes always in stock.

Variometer, complete, less dial . . .	\$3.50	Variocoupler, complete less dial . . .	\$8.00
Unassembled	2.50	Unassembled	2.00
Rotor and stator sections, with hardware	1.50	Tube rotor and hardware	1.00
		Amplifying transformers	3.50

\$10.00 will bring you 2 Variometers, 1 Variocoupler, complete, with dials. Postage extra.

If its Radio, we have it. Send stamp and receive your copy each month of our Radio Bulletin.

Construct your own parts—detailed instructions 40c

NEWCO RADIO & ELECTRICAL SUPPLY CO.
Stratford, Conn.

RELIABLE RADIO SUPPLIES

We carry a complete line.
Made by well known manufacturers.
OUR CATALOG MAILED FREE EVERYWHERE
H. GOLDBERG
Established 1894
1373 Third Avenue (Near 78th St.) NEW YORK

ATTENTION Radio Manufacturers!

We have a complete organization and all modern factory equipment for the efficient making of

High-Grade Woodwork for Wireless

Handsome mahogany or quarter-sawed oak cabinets, boxes, panels, mountings and bases, rotors, stators, etc.

Submit your requirements and we will promptly quote attractive prices.

THE PILLIOD LUMBER CO.
DEPT. "R" SWANTON, OHIO

WARREN RADIO LOOP

NO AERIAL LESS STATIC

IF DAD SAYS—
 "No AERIAL ON THIS HOUSE" don't allow his QRM to worry you, but purchase a WARREN RADIO LOOP

The LOOP that made the Radio Roller Chair famous on the Boardwalk at Asbury Park, N. J.
 Type A737 (300-700 meters)..... \$10.00
 Type A7236 (175-1000 meters)..... 12.00
 Send your order through your dealer or direct to us with his name.

V-DE-CO RADIO MFG. CO.
 Dep't N ASBURY PARK, N. J.
 Send for bulletin No. T101

presumably because of the greater influence of the sun on the earth and its atmosphere during that season. Unfortunately, no way of avoiding this difficulty is known today. The transoceanic radio stations have to be equipped with high power apparatus in order to work through the bad periods of the day and year, although at certain times of the day and year less power may be used, as evidenced by the successful trans-Atlantic transmission by low power amateur stations during the past winter.

For the sake of clearness, we have so far described the cause of fading signals as due to obstructions in the path of the radio waves. Actually, the radio clouds sometimes reflect the waves, much as a mirror does a light wave, and so very peculiar reception effects are sometimes noticed. Sometimes the signals are made stronger instead of weaker, sometimes they may be lost altogether, as the several effects of reflections and absorption combine.

And now let us consider for a moment that arch enemy of radio—Old Man Static. When Marconi first began to receive messages over distances of a few miles, he noted, besides the signals he was listening for, noises which had nothing to do with the signals, and every receiving operator since that time has heard those same disturbing and interfering noises. These noises have been called strays, or atmospherics, or static, and the elimination of them is the most important problem in radio communication today. The intensity of this disturbance is different at different parts of the earth's surface, being progressively worse from the temperate to the tropical zones. The intensity of static varies greatly with the seasons of the year. For example, in the northern part of the United States it is practically absent during the winter months, increasing during the spring, and is most severe during the summer. There are at least two or three kinds of static, but the most troublesome kind is the one which is due to traveling electric waves, in nature just like radio waves, and caused by electrical disturbances somewhere in space. A lightning flash produces a traveling electric wave, much like a radio wave, and if we can assume that lightning flashes, large and small, are occurring continuously somewhere, we have a reasonable explanation of static. Of course, these discharges are not all lightning to the earth, the majority being small discharges inside of or between clouds. Also it is probable that the continuous atmospheric changes above the surface of the earth, such as the formation of water vapor clouds, are accompanied by electrical disturbances which travel to the earth.

We know that static is worse in the summer when variations in the atmosphere are greater and more frequent. Also it is often observed in the winter time that the formation of snow causes static. Without knowing definitely the origin of this disturbance, it seems safe to assume that the actions which take place in our atmosphere, due to the air, the sun, sun spots, water vapor, etc., are responsible for the creation of these irregular, irresponsible and very troublesome waves which we call static. Since they are so much like the radio waves in nature, no way has yet been found of eliminating them completely. Progress has been made in the last few years, however, and the transoceanic stations are much more free of this interference than formerly. The problem of complete elimination of static is the most difficult one in radio, and if solved we shall have a new epoch in radio because the power of transmitting stations can be greatly reduced and the reliability of communication increased.

DAMPED OR UNDAMPED?

Marcel waves are another kind of waves affected by a storm.

By A. J. deLong

"RED-HEADS"
 THE LAST WORD IN RADIO RECEIVERS
 at your dealers or send direct to
 Newman-Stern
 CLEVELAND, OHIO.

Always insist upon getting

NAA Arlington
 Tested
 Radio Crystals
 The original Tested Minerals Galena, Silicon or Goldite, 25c Mounted in Brass Cup, 40c
THE NEWMAN-STERN CO.
 CLEVELAND - - OHIO

When you see the name **TEAGLE** on a radio instrument you know that it is a better piece of apparatus. Send for catalog.
 Teagle Radio Division of
THE NEWMAN-STERN CO - CLEVELAND, OHIO

Radio Supplies

Clapp-Eastham, Paragon, Westinghouse RECEIVING SETS
 Western Electric, Baldwin, Murdock and Brandes PHONES
 Cunningham Tubes
 Magnavox Loud Speakers
 Remler Products
 Radio Corporation Apparatus
 22½ Volt Tapped B. Battery, \$2.75

ELECTRIC SUPPLY CO.
Everything in Radio
 PORT ARTHUR, TEXAS

VULCANO

RADIO TORCH

Self-Heating Soldering Iron, blow torch combination.
 Postpaid for \$2.50

Latest Device
BIG HIT

with electricians and mechanics. Points on Radio soldering FREE. Certificate of honorable mention from Radio Inst. of the N. Y. Evening Mail.
 AGENTS WANTED

NATIONAL RADIO SALES CO.
 32r UNION SQ., N. Y. C.

Audio Frequency

Thornton Amplifying Transformer

"The Transformer Supreme"

We still have territories open for Jobbers
 Write for particulars

Thornton Transformer Co., Inc.
 30 Church St., New York

C. W. APPARATUS OF ALL KINDS
 Detector and One-step Amplifier in cabinets..... \$35.00
 C. W. Chemical Rectifiers, complete, 500 mill-amp. Cap. 14 jars, will handle ½ amp. at 1,000 volts or less. In cabinets..... 9.50
 Prompt shipment
JONES ELEC. & RADIO MFG. CO.
 120 E. Lexington St. Baltimore, Md.

For Reliable Broadcast Reception Use a
"Cramer Radio Broadcast Receiver"

Handsome in appearance; simple in control; highly efficient in operation, it receives concerts with remarkable clarity. Fulfills every desire of those who are particularly exacting in their requirements. Price, without receivers, batteries and tube, only \$35. Prompt shipment.
 Order one today or send for circular
W. R. Cramer Co. Omaha, Nebr.

OUR 3 FACTORIES

are dedicated to building only the best kind of Radio Apparatus. Our complete line of sets and parts carries our unqualified guarantee.

FREED-EISEMANN RADIO CORPORATION
 225-4th Ave. NEW YORK

An Unusual Broadcast

By HOWARD S. PYLE, R. E.

On the evening of Wednesday, June 14, National Flag Day, a distinct departure from the usual method of broadcasting entertainment was performed by a radio company at Cincinnati, Ohio.

It being one of their regular program evenings, and also being the date set for the anniversary exercises of the Cincinnati Lodge No. 5, B. P. O. E., it was decided to combine the two, and broadcast the entire program of the Elks in place of the regular concert by artists who sing for WMH. At first hand this sounded as though it would be a simple task, inasmuch as the exercises were to be held less than one-half mile from the broadcasting station. It was thought that a direct line extending the microphone to the band-stand in Eden Park, the scene of the activities, would serve the purpose. It was found impossible, however, to secure a direct line, the only arrangements that could be made being to use a loop of eleven miles of wire, which ran through two telephone exchanges. This, it will be readily seen, presented considerable engineering difficulties, which were finally overcome after two days of continuous experimental work, but the voice finally passed satisfactorily over this great stretch of wire, and transferred to the air at WMH.

It was found impossible to use the ordinary amplifying circuits for speech pick-up, due to considerable induction, as the line to the broadcasting station was a parallel conductor, bound in a cable with numerous telephone trunks. It was therefore necessary to develop an entirely new type of circuit, which is believed to be a distinct step forward in radio broadcasting of programs at a distance from the transmitting station.

As to the results obtained, the reports which were received by telephone, in person, and by mail were to the effect that nothing to equal it had ever been heard from any other broadcasting source. The modulation was said to be as nearly one hundred per cent perfect as it would be possible to achieve. The strength of the signals was enormous compared to their former strength using conventional circuits.

The entire program was run off without a hitch, and the microphone placed at the scene of the exercises not only picked up the speakers and band, as well as the applause of the crowds, but also very clearly and distinctly gathered the steam-whistle signals from a passing river boat about two miles distant. Not the slightest distortion or foreign noises of any kind were encountered, and it is believed that a distinctive step forward in long distance broadcasting has been obtained.

Book Review

RADIOPHONE RECEIVING

By

ERICH HAUSMANN, Sc.D.,
ALFRED N. GOLDSMITH, Ph.D.,
LOUIS A. HAZELTINE, M.E.,
JOHN V. L. HOGAN
JOHN A. MORECRAFT, E. E.,
FRANK E. CANAVACIOL, E.E.,
ROBERT D. GIBSON, E.E., and
PAUL C. HOERNEL, E.E.

Cloth covers, 5"x7½", 179 pages, with photographs and diagrams. Published by D. Van Nostrand Company, New York.

This work marks a new departure in radio text books. The various chapters are written by different authors, each of whom is an acknowledged authority on the subject treated. The chapters are arranged in the natural rotation which would be selected by a single author and combine to form a most complete and descriptive treatise of the various aspects of radiophone reception. Although the authors are well-known Profes-

KENNEDY
EQUIPMENT

Type 110
Regenerative
Receiver
with Type 525
Two-Stage
Amplifier



KENNEDY
EQUIPMENT

All Kennedy
Regenerative
Receivers
are Licensed
under
Armstrong U. S.
Patent No. 1,113,149

KENNEDY

Universal Regenerative Receiver

Type 110

Is designed to meet the requirements of those who wish to cover the entire field of Radio. It permits of reception on all wave lengths in use today by

Government, commercial, amateur, special and all broadcasting stations. Coupled with Kennedy Amplifier Type 525 it affords the user access to every field of Radio.

Type 110 Receiver can be made to detect, regenerate, or oscillate at will, with high efficiency, over its entire range of 175 to 25,000 meters.

KENNEDY RADIO EQUIPMENT IS SOLD BY GOOD DEALERS EVERYWHERE

Write for Latest Bulletin C-3

THE COLIN B. KENNEDY COMPANY

INCORPORATED

RIALTO BUILDING

SAN FRANCISCO

K.Q.V.—Pittsburgh—BROADCASTING STATIONS—Washington, D. C.—W.M.U.

For Best Results Use the Stromberg-Carlson Radio Headset



Stromberg-Carlson
No. 2A Headset

\$7.50

The Stromberg-Carlson No. 2-A Headset reproduces broadcasted, long-distance vocal or musical sounds with unequalled distinctness. Fine tonal qualities, extreme sensitiveness and superior construction are its important features.

Order Above and Following Highest Grade Supplies by Mail
Immediate deliveries on all items listed

Aeriola Senior Westinghouse Receiver.....	\$ 65.00
Aeriola Grand Westinghouse Receiver.....	325.00
DeForest Radiohome DT 700 less Batteries, Bulbs and Headset.....	36.00
DeForest 2 stage Amplifier DT 800 less Bulbs and Batteries.....	35.00
Simplex Variometers.....	5.00
King Amplitude Horns.....	12.00
Holtzer-Cabot Headset.....	7.50
UV 201 Radiotron Detector Bulbs, each.....	6.50
No. 766 Eveready VT Batteries, each.....	3.00
Gould 6 volt, 60-80 ampere Storage Batteries.....	23.00

Enclose Certified Check or P. O. Money Order, including postage

DOUBLEDAY-HILL ELECTRIC CO.

WASHINGTON, D. C.

Radio Catalogue on Request

PITTSBURGH, PA.

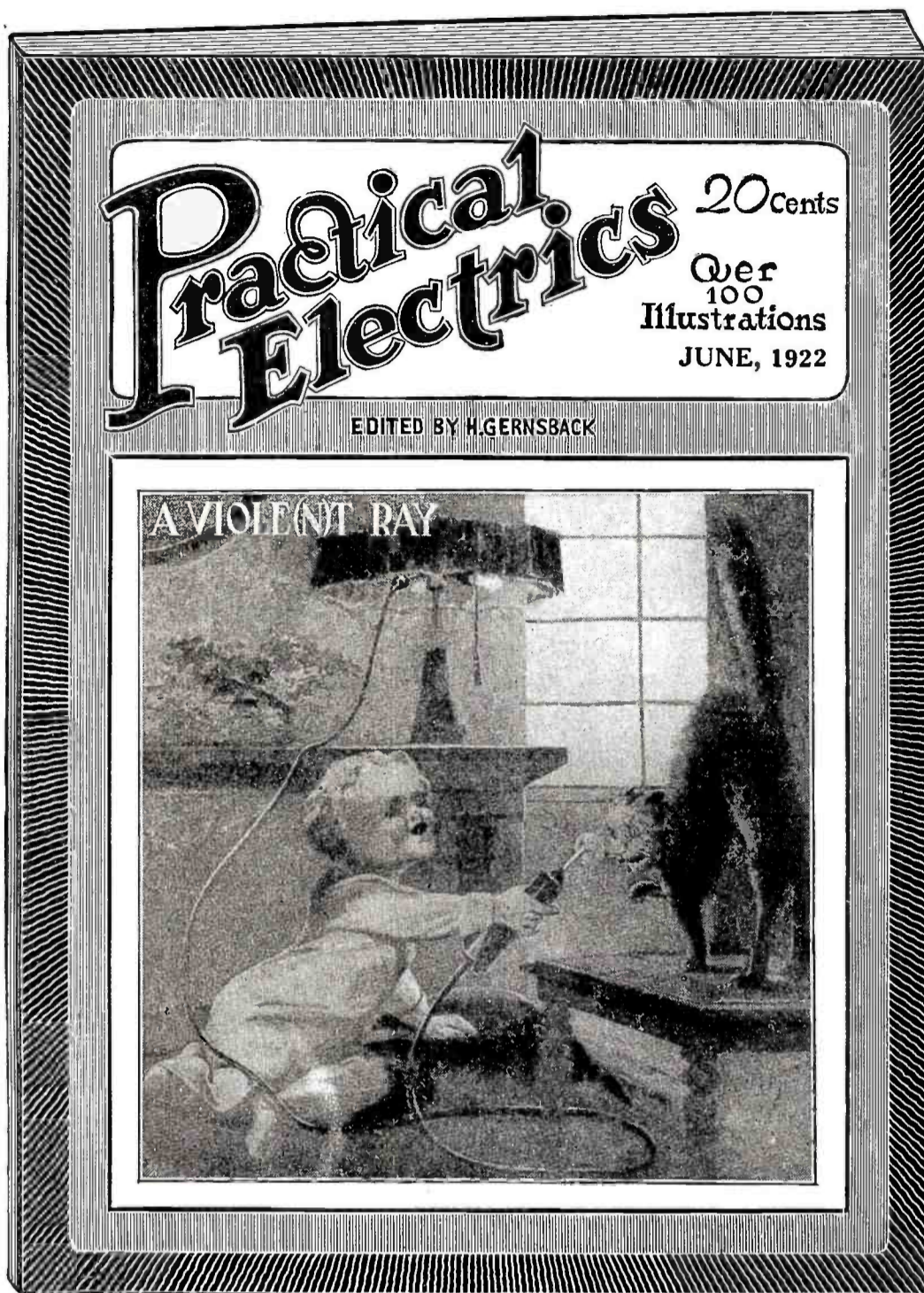

100 Articles
Over 100 Illustrations

FOR SALE
AT ALL NEWS
STANDS

20c
The Copy
\$2.00
A Year

Canada and Foreign
\$2.50 A Year

SEND
20c. FOR
SAMPLE
COPY
TODAY

SEE COUPON BELOW FOR
SPECIAL OFFER

“The Electrical Magazine for Everybody”

PRACTICAL ELECTRICS is probably the most novel magazine of its kind ever conceived. It is personally edited by H. Gernsback, editor of SCIENCE & INVENTION and RADIO NEWS. Mr. Gernsback, who founded the old MODERN ELECTRICS as well as the ELECTRICAL EXPERIMENTER, knows thoroughly what the public wants and has wanted for many years. In presenting this new magazine he but heeds the thousands of letters received by him to establish a new 100% electrical magazine that will beat the best that was in MODERN ELECTRICS and ELECTRICAL EXPERIMENTER.

Electricity covers such a tremendous field that the man who does not keep abreast with it does himself a great injustice. PRACTICAL ELECTRICS covers that field from every angle. It is written in plain every-day language that all can understand. It portrays the

entire electrical development of the month faithfully in non-technical language. It caters to everyone interested in electricity, be he a layman, an experimenter, an electrician or an engineer—each will find in this magazine a department for himself and plenty more.

The July issue contains 48 pages and over 100 different articles and over 100 illustrations, with an artistic cover in two colors. Professor T. O'Connor Sloane, Ph.D., is associate editor of the magazine.

Leading Articles in the July Number

Automatic Train Control, by Frank J. Sprague. Electroscopy, by T. O'Connor Sloane, Ph. D. A Laboratory Ultra-Violet Electric Lamp. True Electrical Experiences (Continued), by H. Winfield Secor, Assoc. Member, A. I. E. E. Thermo-Dynamic Electricity by F. R. Kingman. Tesla's Electrolytic Clock.

PRIZES

This magazine offers a number of prizes, as follows:
\$3.00 for the best picture of your electrical workshop.
\$3.00 for the best article on Elec-Tricks, the new department.
\$3.00 for the best "short-circuit," the semi-humorous department.
In addition to this, the magazine pays high prices for all electrical experiments, electrical articles, etc.

See Current Issue for Full Details.

This issue also contains articles by some of the greatest living electrical writers, workers and students and the magazine will prove a revelation to any one interested in electricity.

Inasmuch as the new magazine has a circulation of only 33,000 copies, we urge you to place your monthly standing order with your newsdealer at once. Or if you wish, fill out the coupon below for your subscription and take advantage of our special offer.

Every issue besides its many other features contains the following departments:

- "New Things Electric"
- "Experimental Electrics"
- "Electrical Digest"
- "Junior Electrician"
- "My Laboratory"
- "Elec-Tricks"
- "Motor Electrics"
- "Short Circuits"
- "How and Why" (Questions and Answers).

Make all checks payable to: "Practical Electrics Co."

SPECIAL OFFER

Gentlemen:

Although your regular price is \$2.00 per year, you will accept my subscription at \$1.75 per year (Canada and foreign \$2.25). I enclose the money herewith and I have written my name and address in margin below.

PRACTICAL ELECTRICS CO., 53 Park Place, New York

R. N. 8-22

sors and Engineers, they have purposely chosen the simplest language in their explanations, and have avoided the use of highly technical expressions or mathematical formula. The authors have presented in a clear and simple manner the methods and apparatus used for radiophone reception. The book will appeal to the layman, the novice and the amateur radio enthusiast alike.

THERMIONIC TUBES IN RADIO TELEGRAPHY AND TELEPHONY

By JOHN SCOTT-TAGGART

Cloth covers, 5½"x8½", 424 pages with illustrations and about 350 diagrams. Published by the Wireless Press, Inc., New York.

This latest book by Mr. Scott-Taggart possesses something of value to all engaged in radio work, from the engineer to the operator and experimenter. The method of presenting the subject is such as to be easily understood by the student without previous experience; nevertheless, the subject is gradually expanded so as to cover the whole subject of vacuum tubes in sufficient detail to make the student ultimately independent of a text-book. Throughout the volume theoretical circuits have been invariably followed by actual, practical working arrangements. It is the most complete book on the subject of vacuum tube theory and operation.

HOME RADIO

By A. HYATT VERRILL

Cloth covers, 4½"x7", 115 pages with illustrations and diagrams. Published by Harper & Brothers, New York.

No attempt is made in this book to enter deeply into an explanation or discussion of the scientific phase of radio transmission. It is intended and designed particularly for the use of amateurs, boys, and those who wish to know how to make and operate wireless telephone instruments. The author has made his explanations as brief and simple as possible with numerous diagrammatic figures to illustrate the subject treated.

HOW TO MAKE COMMERCIAL TYPE RADIO APPARATUS

By M. B. SLEEPER

Paper covers, 5¼"x8", 159 pages with illustrations and diagrams. Published by the Norman W. Henley Publishing Company, New York.

This work illustrates many of the standard commercial types of receiving and transmitting apparatus. The circuits used and a brief explanation of their operation are given. The book is written and illustrated with the idea that the experimenter will benefit and get many ideas which will help him in the perfecting of his own equipment.

THE A B C OF VACUUM TUBES IN RADIO RECEPTION

By E. H. LEWIS

Cloth covers, 5"x7½", 132 pages with numerous diagrams.

This book is written to satisfy the desire for elementary information regarding vacuum tubes as used in the reception of radio telephony. Mathematics has been especially avoided in the treatment of the subject, and no technical terms are used without their meaning being clearly given. The practical questions and answers will be of value to those who are contemplating the installation of receiving equipment or who are obtaining unsatisfactory results through lack of insufficient information.

BLANDIN TRIPLE A

Radio Cabinets

BUILT of the finest select mahogany, walnut and quartered oak—by an organization of men who have had many years' experience in the production of fine cabinetwork and finishing.

Blandin Triple A cabinets are an economy, because their quality and appearance add greatly to the intrinsic sales value of receiving apparatus.

It will pay you, manufacturers and distributors, to write now for quotations on regular or special sizes.

You will then be assured of deliveries this fall.

BLANDIN PHONOGRAPH COMPANY, Inc.
1200 SIXTEENTH STREET
RACINE, WISCONSIN

The more you know about radio, the more you will realize the importance of good insulation.

Condensite

possesses all the properties essential to radio insulation and in addition shows in appearance its exceptional quality.

Condensite Company of America
BLOOMFIELD, N. J.

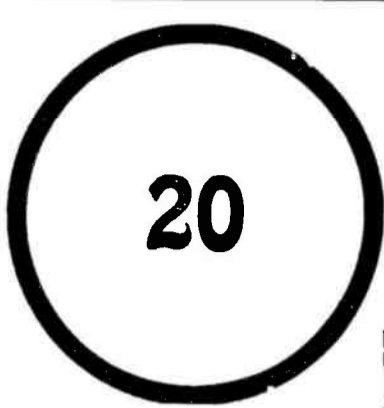

TWENTY RADIOPHONE DIAGRAMS

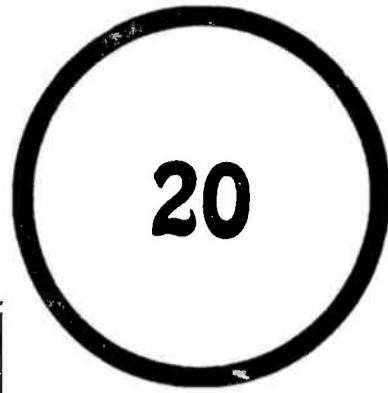

The most complete selection of diagrams and hook-ups for **RADIO AMATEURS** enabling anybody to rig-up a wireless

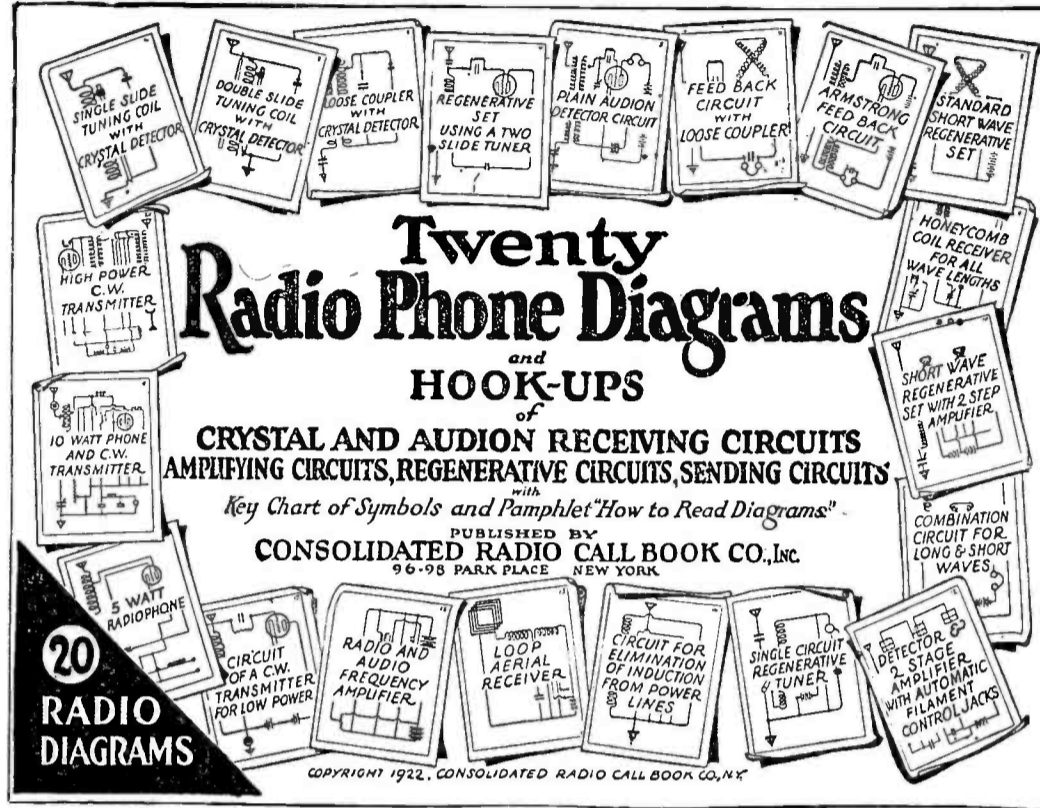

telephone outfit from the simplest crystal detector circuit, to the most ultra-modern regenerative and amplifying radio set.

TITLES of DIAGRAMS

1. Single Slide Tuning Coil with Crystal Detector.
2. Double Slide Tuning Coil with Crystal Detector.
3. Loose Coupler with Crystal Detector.
4. Regenerative set, using 2 slide tuner.
5. Plain Audion Detector Circuit.
6. Feed-back Circuit with a Loose Coupler.
7. Armstrong Feed-back Circuit.
8. Standard Short Wave Regenerative Set.
9. Honey-comb coil Receiver for all wave lengths.
10. Short wave regenerative set, with 2 step Amplifier.
11. Combination Circuit for Long and Short Waves.
12. Detector and Two stage Amplifier with automatic Filament control Jacks.
13. Single Circuit Regenerative Tuner.
14. Circuit for elimination of induction from power lines.
15. Loop Aerial Receiver.
16. Radio and Audion frequency amplifier.
17. Circuit of a C.W. Transmitter for low power.
18. 5 Watt Radio-Phone.
19. 10 Watt Phone and C.W. Transmitter.
20. High Power C.W. Transmitter.

COMPLETE SET OF 20 RADIOPHONE DIAGRAMS

consisting of twenty blueprint diagrams, size 8½ x 11½ inches, and one four page direction-pamphlet, 8½ x 11½ inches, containing: Illustrated Symbol Key Chart, Direction How to Read Diagrams, How to Follow Circuit, etc., and explanation of each diagram. All contained in heavy, two color printed envelope, size 9 x 12 inches.

PRICE 50c FOR THE COMPLETE SET OF 20, SHIPPED PREPAID

Either Direct from us or for sale by the following responsible Dealers:

- | | | | |
|--|--|---|--|
| Alamo Sales Corp. Indianapolis, Ind. | Fenno Co., R. F. N. Y. City | Meyberg Co., Leo J. San Francisco, Cal. | Rose Radio Supply New Orleans, La. |
| Am. Electro Tech. App. Co., N. Y. City | Fergus Elec. Co. Zanesville, O. | Milnor Elec. Co. Cincinnati, Ohio | Roy News Co., Fre'k J. Toronto, Can. |
| American Hdw. Stores, Bridgeport, Conn. | Findley Electric Co. Minneapolis, Minn. | Mohawk Elec. Sup. Co., Syracuse, N. Y. | Sands Electric Co. Wheeling, W. Va. |
| Andrea & Sons, Julius, Milwaukee, Wis. | Fleron & Son, M. M. Trenton, N. J. | Montgomery-Ward & Co. Chicago, Ill. | Sayre-Level Radio Co. Phila., Pa. |
| Andrea & Sons, Julius, Mason City, Ia. | Fuller Co., Seth W. Boston, Mass. | Morehouse-Martens Co. Columbus, Ohio | Schmidt & Co., R. Rochester, N. Y. |
| Anthracite Radio Shop Scranton, Pa. | Gainday Elec. Co. Pittsburgh, Pa. | National Radio Corp. Atlanta, Ga. | Sears, Roebuck & Co. Chicago, Ill. |
| Associated Merchandising Corp., N. Y. C. | Galveston W'less Sup. Co., Galveston, Tex. | Nat'l Radio Institute, Washington, D. C. | Shotton Radio Mfg. Co. Scranton, Pa. |
| Atlantic Radio Co. Boston, Mass. | Greene, Jos. E. Boston, Mass. | New England Motor Sales Co., Greenwich, Conn. | Smith Radio Lab. Sarnia, Ont., Canada |
| Bamberger & Co., L. Newark, N. J. | Gurd & Co., Wm. London, Canada | New Era Shop Milwaukee, Wis. | Smith Novotay Elec., Inc., Charlotte, N. C. |
| Banister & Pollard Co., Newark, N. J. | Hall Electric Co., Wm. Dayton, O. | Newman-Stern Co. Cleveland, O. | So. California Elec. Co. Los Angeles, Cal. |
| Beckley-Ralston Co., The Chicago, Ill. | Hartford Elec. Sup. Co. Hartford, Conn. | Nichols Radio Sup Co., Big. Green, Ky. | Southern Elec'l Sup. Co., San Diego, Cal. |
| Benwood, Specialty Co. St. Louis, Mo. | Hatfield Electric Co. Indianapolis, Ind. | Nola Radio Co. New Orleans, La. | Southwest Radio Sup. Co. Dallas, Tex. |
| Bluebird Electric Shop, Jersey City, N. J. | Heustis, A. E. Fitchburg, Mass. | Noil & Co., E. P. Philadelphia, Pa. | Sprott-Shaw Schl. Vancouver, B. C. |
| Brode Electric Co. Los Angeles, Cal. | Hickson Electric Co. Rochester, N. Y. | Northern Radio & El. Co., Seattle, Wash. | Standard Drug Co., The Detroit, Mich. |
| Brown, J. Edw. Glenbrook, Conn. | Hiro Wireless Sup. Co. Marion, Ill. | Northwest Radio Serv. Co., Seattle, Wash. | Steiner Elec. Co. Chicago, Ill. |
| Bunnell & Co., J. H. New York City | Holt Electric Util. Co., Jacksonville, Fla. | N. S.W. Bookstall Co. Sydney, Australia | Steinman Hardware Co. Lancaster, Pa. |
| California Elec. Co., San Francisco, Cal. | Hommel-Ludwig & Co. Pittsburgh, Pa. | Paramount Radio Sup. Co., Atlantic City | Sterling Electric Co., Minneapolis, Minn. |
| Capital Radio Sup. Co. Indianapolis, Ind. | Hook Drug Co. Indianapolis, Ind. | Pearlman's Book Shop, Washington, D. C. | Stubbs Electric Co. Portland, Ore. |
| Carter Electric Co. Atlanta, Ga. | Huey & Philip H'dware Co., Dallas, Tex. | Penn Radio Apparatus Co., Reading, Pa. | Sunbeam Elec. Sup. Co. N. Y. City |
| Central Radio Co. Independence, Mo. | Hughes Elec'l Corp. Syracuse, N. Y. | Penn. Marconi Wireless Schl. Phila. | Tuska Co., C. S. Hartford, Conn. |
| Chase, Geo. H. Newport, R. I. | Iowa Radio Corp. Des Moines, Iowa | Pettingell-Andrews Co. Boston, Mass. | Union Elec. Sup. Co. Providence, R. I. |
| Chesapeake Elec. Co. Baltimore, Md. | Jenkins, Lester I. New Bedford, Mass. | Phila. Schl. of Wireless Tele., Phila., Pa. | United Elec. Stores Co. Braddock, Pa. |
| Chicago Radio Ap. Co. Chicago, Ill. | Kesselman-O'Driscoll Co., Milwaukee, Wis. | Piedmont Electric Co. Asheville, N. C. | United Electric Stores E. Pittsburgh, Pa. |
| Cleveland Co., L. W. Portland, Me. | Keubler Radio Co. Toledo, O. | Pioneer Electric Co. St. Paul, Minn. | United Elec. Sup. Co. Boston, Mass. |
| Cloud & Son Macy, Ind. | Killoch Co., David New York City | Pitts. Co., F. D. Boston, Mass. | U. S. Radio Co. Pittsburgh, Pa. |
| Con. Radio & Elec. Corp. N. Y. City | King Radio Co. Pittsburgh, Pa. | Pitts. Radio Sup. Co. Pittsburgh, Pa. | Virginia Novelty Co., Martinsburg, W. Va. |
| Continental Elec. Sup. Co., Washington, D. C. | Klaus Radio Co. Eureka, Ill. | Pitts. Radio & App. Co., Pittsburgh, Pa. | Warner Bros. Oakland, Cal. |
| Daily Battery & Equipment Co., Pittsburgh, Pa. | Kluge, Arno A. Los Angeles, Cal. | Port Arthur Radio Lab., Port Arthur, Tex. | Western Radio Co. Kansas City, Mo. |
| Delancey-Felch & Co. Detroit, Mich. | Knoxville Radio Co. Knoxville, Tenn. | Post Office News Co. Chicago, Ill. | West'n Radio Elec. Co., Los Angeles, Cal. |
| Delancey-Felch & Co. Pawtucket, R. I. | Kusel Co., D. & F. Watertown, Wis. | Precision Equipment Co. Cincinnati, O. | Wetmore-Savage Co. Boston, Mass. |
| Detroit Electric Co. Detroit, Mich. | Lehigh Radio Co. Bethlehem, Pa. | Quaker Light Sup. Co., The Phila., Pa. | Wheeler Green Electric Co., Rochester, N. Y. |
| Dewey Sptg. Goods Co. Milwaukee, Wis. | Liberty Incandescent Sup. Co., Pittsburgh, Pa. | Radio Distributing Co. Newark, N. J. | Whitall Elec. Co. Springfield, Mass. |
| Doubleday-Hill Elec. Co. Pittsburgh, Pa. | Liberty Radio Sup. Co. Chicago, Ill. | Radio Electric Co. Pittsburgh, Pa. | Whitall Electric Co. Westerly, R. I. |
| Dreyfuss Sales Co. New York City | Linze Elec'l. Sup. Co. St. Louis, Mo. | Radio Equipment Co. Boston, Mass. | Williamson Elec. Co. Seattle, Wash. |
| Duck & Co., Wm. B. Toledo, O. | Litscher Elec. Co., C. J. Grand Rapids, Mich. | Radio Equip't. & Mfg. Co., Minneapolis | Wilmington Elec. Spec. Co., Wilmington |
| E. S. & E. Co. Hartford, Conn. | Ludwig Hommel & Co. Pittsburgh, Pa. | Radioelectric Shop Cleveland, O. | Wilson Co., Harold K., Grundy Center, Iowa. |
| Electro Importing Co. N. Y. City | Luther, H. E. Centerville, Ia. | Ray-Di-Co. Chicago, Ill. | Winner Radio Co. Aurora, Colo. |
| Elite Electric Shop El Paso, Tex. | Manhattan Elec. Sup. Co. Toledo, O. | Reynolds Radio Denver, Colo. | Wireless Mfg. Co. Canton, O. |
| Erie Book Store Erie, Pa. | Marshall-Gerken Co. Toledo, O. | Reuter Electric Co. Cincinnati, O. | Wolfe Electric Co. Omaha, Neb. |
| Farley & MacNeill Boston, Mass. | McCarthy Bros. & Ford, Buffalo, N. Y. | R. I. Elec. Equip't. Co. Providence, R. I. | Zamoiski Co., Jas. M. Baltimore, Md. |
| Farrington & Clark Boston, Mass. | McMillan Bros. Pittsburgh, Pa. | Riverside Laboratory Milwaukee, Wis. | Zibart Bros. Nashville, Tenn. |
| Federal Elec. Sup. Co. Detroit, Mich. | Merchant, A. P. & Co. Boston, Mass. | Robertson-Cataract El. Co., Buffalo, N.Y. | |

Consolidated Radio Call Book Co., Inc., 98 Park Place, New York City

AMATEUR RADIO

By MAURICE J. GRAINGER

Paper covers, 5"x7½", 158 pages with illustrations and diagrams. Published by the James A. McCann Company, New York.

This book has been compiled especially for the amateur owner of a radiophone receiver who knows little or nothing about how and why his instruments work. It satisfies the curiosity of the large and growing class of radio enthusiasts who desire a simple explanation of the operation of their receivers.

RADIO QUIZZ BOOK

By JAMES E. SMITH

Paper covers, 6"x9", 100 pages with illustration and diagrams. Published by the National Radio Institute, Washington, D. C.

The purpose of this book is to furnish its readers with a suitable preparation in the operating principles, constructive features, diagrams of connections, maintenance and repairs of radio equipment used by commercial stations. It also includes the essential laws governing radio communication, together with useful formulæ and tables employed in the solution of radio problems. The answer to each question is given in a clear and concise manner. These questions and answers have been developed from notes collected by the author during the past seven years while training hundreds of students for the United States Government Radio Operators' License Examinations.

MARINE WIRELESS POCKET-BOOK

By W. H. MARCHANT

Cloth covers, 4"x6½", 180 pages with numerous diagrams and figures. Published by Sir Isaac Pitman and Sons, Ltd., New York.

This pocket-book is intended to meet chiefly the needs of the practical marine radio operator. The book is divided into six sections and contains detailed instructions regarding the adjustment of the various standard Marconi sets and those of the Telefunken and Radio Communication Company. Uses of such testing and measuring instruments as the wavemeter, decimeter and galvanometer are described. Included in the book are various tables which will be of assistance to the operator.

CONSOLIDATED RADIO CALL-BOOK

Published by the Consolidated Radio Call Book Company, New York. Paper covers, 5"x9", 280 pages.

This latest edition of the call-book gives the most complete list of the call-letters of all ship and shore stations. For the convenience of steamship owners as well as radio operators, the shore stations have been arranged under two general heads: those which receive and transmit commercial traffic and those which are not open to this class of service. The radio amateur in particular will recognize the value of this book as it gives authentic data on American amateur stations. In addition to the listing of the call-letters there has been included considerable timely information connected with present radio development such as the radio compass, radio cable and telegraph rates, weather reports, press schedules, position reports, and general radio procedure as well as complete maps showing the locations of the stations.

TESTS APPROVED FOR RADIO RECEIVING SETS

The Bureau of Standards of the Department of Commerce and the Electrical Testing Laboratories of New York have ap-

COMPLETE SET

For

\$10⁰⁰

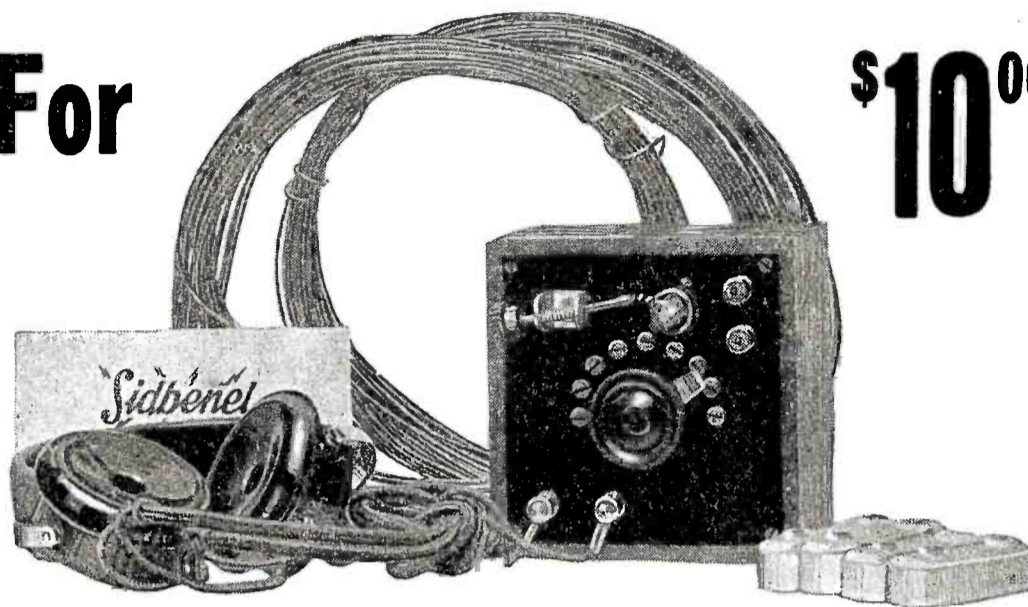

The most practical and highly perfected low priced broadcasting receiver made. It will bring in Concerts, General News and Farm Reports exceptionally loud and clear and will tune from 150 to 1800 meters. The tuning is exceptionally sharp with a minimum of interference. We receive letters from all parts of the country telling us that this Receiver has brought in concerts and voice for a distance of over 25 miles and in exceptional cases 75 miles.

The complete outfit consists of a "SIDBENEL" highly sensitive specially wired tuning cabinet, handsomely finished in mahogany; 150 feet of solid copper wire for antenna; porcelain insulators; a 1000-ohm supersensitive head receiver with leather headband and telephone cord; a highly tested crystal detector and complete instructions for installation and operation.

Complete set, knocked down (no receiver).....	\$5.50
Complete set, knocked down (with receiver).....	8.00
Complete set, assembled, ready to use with 1000-ohm phone.....	10.00
Complete, with extra long range coil.....	11.50
Complete, with double concert receivers.....	15.00

If your dealer has not received his supply send check to us direct at once for immediate delivery. Orders shipped day received.



RADIO EQUIPMENT MFG. CO.
1663 Jerome Avenue
New York City

GUARANTEE

"SIDBENEL" sets are guaranteed to equal or surpass in performance any outfits selling at triple the price. Money back if not as represented.

Manufacturers of Vacuum Tube Sets, "SIDBENEL" Radio storage "B" batteries (Pats. applied for); switches, dials, taps and other Radio accessories.

IMPORTANT RADIO BOOKS

AT EXCEPTIONALLY LOW PRICES

Wireless Course in 20 Lessons

By S. Gernsback, A. Lescarbourea and H. W. Secor, E. E.

(10th EDITION)



A Course that tells you everything you want to know about "Wireless," starting off in lesson No. 1 by explaining the Principles of Electricity. By simple, easy stages, this wonderful Course takes you into "Wireless" by the use of such simple language so skillfully used that of necessity you must understand every word. There is a whole lesson devoted to the Theory and Mathematics of this epoch-making subject. The last lesson is devoted to a history of Wireless.

This Course has been considerably revised in order that it meet some of the many important changes which have occurred in Radio Telegraphy and Telephony within recent years. Much valuable data and illustrations concerning the Vacuum Tube has been added. This comprises the theory of the Tube as a detector and as an amplifier, and in addition has been included modern amplification circuits of practical worth. Incidentally, space has also been devoted to the development of the Radio Compass as operated and controlled by the United States Navy with its consequent great aid to present-day navigation.

Size of book is 7x10¼ inches, 160 pages, 350 illustrations, 30 tables.

"Wireless Course in Twenty Lessons" Cloth bound in Vellum de Luxe, stiff covers, hand-sewed, gold stamped. **\$1.75**

A Thousand and One Formulas

By S. GERNSBACK

A Laboratory Hand Book for the Experimenter and for Everybody who wants to "do things."

A Book, brimful with very important and priceless information, collected and selected for years. The recipes and formulas are classified in such a manner as to be available at once, without long research.

Invaluable for Students, Engineers, Physicians, Experimenters, etc. Here are some of the chapter headings:

Cements and Glues; Compositions of All Kinds; Glass and Glassworking; Ink; Leather Polishes; Metal-craft; Perfumery, Soaps and Extracts; Photography; Blue Print and other Paper; Plating; Pyrotechny; Polishes and Stains; Varnishes and Paints; Various Cleaning Formulas; Wood-craft; Chemical Laboratory Hints and Experiments; Mechanical Laboratory Hints and Experiments; Electrical Laboratory Hints and Experiments.

Besides there are a score of tables and hundreds of Illustrations and Diagrams.

It contains 160 pages. The paper has been especially selected to stand rough handling in laboratories.

Size, 6x9 inches. "A Thousand and One Formulas" Cloth bound in Vellum de Luxe, stiff covers, hand-sewed, gold stamped. **\$1.75**

THE EXPERIMENTER PUBLISHING CO.

Book Dept.—53 PARK PLACE

NEW YORK



**104
PAGES**
**65
ARTICLES**
**175
ILLUSTRATIONS**
**16
PAGES
ROTOGRAVURE**

**ON ALL
NEWS STANDS**
25c The Copy
**SUBSCRIPTION
PER YEAR**
(12 Numbers)
\$2.50
(Add 50c outside
U. S.)

EXCLUSIVE RADIO ARTICLES A SPECIAL FEATURE

TELEVISION BY RADIO!
How Future Generations will see Baseball Games by Radio a thousand miles away. An amazing story of a coming invention. Don't miss it!

Some of the Radio Articles in the July Issue

Freaks of Railroad Radiophone. French Radiophone Station at Night. Radio for the Beginner—No. 5—How a Radiophone Receiver Makes You Hear Sounds from Afar. Radio Amplification—Best Methods. Simplest Radiophone Receiver. Radio Broadcast. Photos of Radio Broadcast Stations. Radio Oracle—Question and Answer Box. The Radiophot—Television by Radio.

SCIENCE AND INVENTION is just chock full of interesting articles and illustrations that appeal to everyone. It will hold your interest from cover to cover because it contains everything new in the field of science, invention and mechanics. Quoted by hundreds of newspapers and magazines all over the world every month.

Its editorial contributions constitute the brains of the scientific world. Its four-color cover designs are both artistic and attractive

Partial Contents for July, 1922

POPULAR SCIENTIFIC ARTICLES
Editorial
Can the "Lusitania" Be Raised?
Unique Double-Deck Subway
First Aerial Lighthouse in America
Airplane Wings Tested by Trailing
What is a Tooth Made Of?
Einstein Relativity Explained in "Movie"
Cooking by Solar Heat
A "Free Pendulum" Clock
Heat and Vacuum to Cure Ills
The Coal Bin of New York City
The Future of the Inventor
40,000 Degrees of Heat
Miracles of the Silver Screen
A Tunnel Thru the Earth!
Dr. Hackensaw's Secrets—No. 7—The Secret of Life

Popular Astronomy—The Earth Viewed from the Moon
Super-Microscope Reveals Nature's Wonders
Typewriter for Blind
The Radiophot—Television by Radio—Coming Inventions No. 7
The Amateur Magician
PRIZE CONTESTS
Motor Hints—\$50.00 in Prizes for Ideas
How-To-Make-It Department—\$30.00 in Prizes
Wrinkles, Recipes and Formulas—\$5.00 Monthly Prize
Old Inner Tube Contest Winners
AUTOMOBILES
Motor Hints—\$50.00 in Prizes
Old Inner Tube Contest Winners

ELECTRICITY
Motor Hints—Electrical Ideas for the Motorist
An Electrical Railway for the Kiddies
Experimental Electro-Chemistry
How-To-Make-It Department
The Oracle—Question and Answer Box
Patent Advice
CHEMISTRY AND ELECTRO-CHEMISTRY
Practical Chemical Experiments—Paper No. 3—Qualitative Analysis
Experimental Electro-Chemistry—Third Paper of a New Series
Wrinkles, Recipes and Formulas
CONSTRUCTOR ARTICLES
A Home-Made Telescope
Currentless Garage Door Bell

Experimenter Publishing Company

53 Park Place

New York

Gentlemen:
Please enter my subscription for Science and Invention for the term of one year for which I enclose herewith \$2.50 (add 50c for postage outside of United States).
Name.....Town.....
Address.....State.....

Beautiful California Redwood Cabinets

MOUNT your set in one of these; polish, natural; you will have handsomest outfit you have ever seen. Also takes swell mahogany finish. Knocked down. Size: 6 in. deep, 6 in. high.

LENGTHS	PRICES
5 3/8 in. - - -	\$1.25
7 3/8 in. - - -	1.50
10 1/2 in. - - -	1.75
16 1/2 in. - - -	2.50
22 in. - - -	3.25

Send money order or draft. Orders filled promptly. Money back if not satisfied. Dealers write for proposition.

H. C. Graham & Co.
310 N. Broadway, Los Angeles, Cal.

DEALERS! DEALERS!

We Are Distributors of

DeForest Radio Equipment and

Western Electric, Stromberg-Carlson
and Mesco Phones

Western Electric Two-Step Amplifier
and Loud Speaker, Complete with
3 Tubes

Klosner Rheostats, Thordarson
Transformer, Variable Condens-
ers, Variocouplers, Variometers

Write for Prices Prompt Delivery

WHOLESALE ONLY.

ALDAN ACCESSORY CO.
Manufacturers' Distributors

5 Columbus Circle, New York

IMMEDIATE DELIVERY

Westinghouse "RA" Tuner, "DA" two-stage Amplifier.....	\$100.00
Clapp-Eastham "HR" Receiver and "HZ" two-stage Amplifier (Mahogany Cases).....	65.00
DeForest "RADIOHOME" Receivers; each.....	25.00
Navy type Loose Couplers, complete, with Crystal Detector and Condenser; each.....	10.00
Double Slide Tuning Coils; each.....	3.00
Western Electric \$12.00, 2200-ohm, "Navy" type Double Head Receivers; each.....	9.00
UV-201 Radiotron Detector and Amplifying Tubes; each.....	5.85
Goods shipped promptly on receipt of Post Office Money Order, and satisfaction guaranteed.	

F. JOS. LAMB COMPANY

1960 Franklin St. Detroit, Mich.

"A"
"B"



**JAXON
RADIO
STORAGE
BATTERIES**

Made of only new materials. Battery shown at left is our new 6-volt 100-amphr. Built especially for Radio use. Three-year guarantee. Write, wire or phone us for our Radio Supply list.

\$5.75

\$25.00

JACKSON BATTERY COMPANY
1124R JACKSON BLVD. CHICAGO, ILLINOIS

proved in outline a method for immediate use in the testing of complete receiving sets manufactured for receiving radio telephone broadcast. Improvements on these methods, or new methods used in testing the equipment submitted by the National Retail Dry Goods Association, will be subject to approval of the Bureau of Standards, which will cooperate with the Electrical Testing Laboratories in the establishment of these methods as standard procedure.

It is recognized that there are a great many other organizations which would be interested in, and benefited by, any action leading toward the making of performance tests and the standardization of radio equipment, and it is desirable that the interest in this work be coordinated as thoroughly as possible.

There were present at the conference on Testing and Standardization of Radio Equipment, held at the Bureau of Standards in Washington, May 26, 1922, Dr. C. H. Sharp and Mr. H. L. Bedenbender, representing the Electrical Testing Laboratories, New York; Mr. Harold R. Young and Mr. Arthur Wiesenberger, representing the National Retail Dry Goods Association; and Dr. J. H. Dellinger, Mr. L. E. Whittemore and Mr. J. L. Preston, representing the Bureau of Standards.

The Investigating Committee of the National Retail Dry Goods Association, composed of F. W. Tully, Chairman, C. S. Hammond, Joseph Fisher, S. J. Ryan and Alfred Fanti, reported that its members very generally are becoming engaged in the sale of radio receiving equipment. They find that there is no information available for them to use in the selection of good apparatus and in the rejection of apparatus which is not satisfactory in operation, and is therefore detrimental to their established good will in their communities.

There was considerable discussion of the need for standardizing some features of the design and construction of radio receiving equipment, for measuring and rating the performance, and for determining which receiving sets are of durable construction. From the commercial standpoint, the Investigating Committee of the National Retail Dry Goods Association had defined the solution as being standardization, by responsible manufacturers, of the efficiency of their various receiving sets, marking plainly on each instrument the receiving radius under every atmospheric condition. The discussion brought out the fact that this is a very difficult problem and one which is impossible to accomplish by a brief statement or mark on the receiving set. A large number of factors enter into the determination of the range over which signals can be received with a given receiving set. These include the strength of signals which the receiving operator expects, the height and location of the receiving antenna, the power of the transmitting station, and its location with respect to other stations which are capable of causing interference as well as the sensitivity of the particular receiving set.

The great need for the development of methods for determining the performance of radio receiving apparatus is a relatively new one and has been made necessary by the recent large production of receiving sets varying enormously in quality and performance. In spite of the desirability for developing thoroughly comprehensive methods for obtaining complete information on the performance of apparatus which would require a considerable length of time, the National Retail Dry Goods Association is anxious to have immediate action which will give such information as can be secured in time to be of service to them in buying for the fall trade. They desire that the reports on the behavior of receiving sets be in such form as to be easily interpreted by a non-technical organization.

The present urgent need, therefore, is for data on their comparative merits which is

"Why Use An Antenna?"

The "SUPER-ANTENNA" Now Available to the Radio Public

Price
\$2.80



The SUPER-ANTENNA is original unit designed for reception over lighting circuits.

It is fool-proof and shock-proof and can be used effectually in place of overhead Antenna.

No power current is used when operating with a "SUPER-ANTENNA."

It operates on any electrical circuit from 32 to 120 volts D. C. or A. C.

Wire or Write for
Quotations

**SUPER-ANTENNA
COMPANY**

Dept. 58

QUINCY - - - ILLINOIS
U. S. A.

Sole Distributors

"Why Use An Antenna?"



CRL

No. 100

Filament Rheostat for Panel Mounting

No Magnetic Material Used in Its Construction

Designed by Radio Engineers to insure quiet, smooth, step-by-step action and maximum sensitiveness. Its current capacity is ample for the control of any receiving tube without overheating.

Both the base and the knob are made of genuine Thermoplax. All metal parts are nicked.

The overall diameter is only 2 1/8 inches—an important factor because of the limited space usually available.

Price (East of Rocky Mountains), \$1.00.

Get a C. R. L. Rheostat from your Dealer or, if he cannot supply you, we will send you one by mail postpaid for \$1.10.

Central Radio Laboratories
303 16th Street
MILWAUKEE WISCONSIN

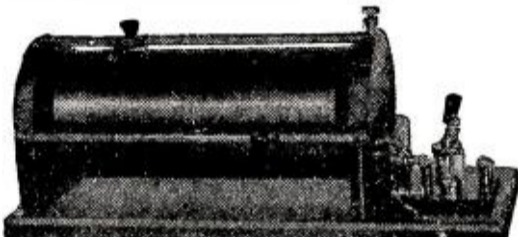

“Mayer’s Wonder” Set

A set, which by actual test, outrivals any crystal machine on the market for clearness, loud tone and receiving distance. This is truly a “real set” with workmanship and material of the highest standard. Consists essentially of a Mayer coil, fixed condenser, double slide and moisture-proof detector. It is substantially built and defies rough usage. You can only appreciate this remarkable set by seeing it and listening in on it.

Base, 13x5 3/4 inches. Height, 6 inches.

**Radio Supply Service
UP-TO-THE-MINUTE**

The radio dealer needs a new kind of jobber service to meet the demands of a new and different business. North Ward Service is developed especially to meet the need. Give it a trial!

<p>JACKS</p> <p>#30 Single Circuit, Open</p> <p>#32 Double Circuit, Closed</p> <p>#31 3-Spring Automatic Filament Control</p> <p>#33 5-Spring Automatic Filament Control</p>	<p>PARTS</p> <p>Binding Posts (unremovable heads)</p> <p>Fixed Condensers</p> <p>Switch Lever</p> <p>Duplex Adapter</p> <p>Crystal Detectors</p> <p>Double Slide Tuning Coils</p>
---	--

Distributors for Brandes “Matched Tone” Phones

Get Our Prices and Discounts

NORTH WARD RADIO CO.
72E ORANGE ST., NEWARK, N. J.

immediately useful and which will be of assistance in the ultimate standardization of receiving sets.

The following outline was drawn up and agreed upon as a suggested method for immediate use in testing of complete receiving sets manufactured for use in receiving radio telephone broadcast reception. As methods are developed which are more refined and which give more specific and quantitative information on the electrical design and operation of the apparatus, these will be applied to the best advantage.

PROPOSED SCHEDULE FOR TESTING RADIO RECEIVING SETS

It is proposed to report on all sets submitted for test in accordance with the following schedule as nearly as practicable. The design, construction and operation of each unit as well as the complete set will be studied and the report given will be based on actual performance and endurance tests as well as a critical examination. Where numerical values cannot be obtained, the comparative merits of any unit will be rated as “good,” “medium,” or “poor.”

A. General Observations

MECHANICAL AND ELECTRICAL DESIGN

- a. General exterior appearance.
 - (1) General symmetry
 - (2) Convenience of design
 - (3) Workmanship
- b. General interior appearance
 - (1) Wiring
 - Size and kind of wire used for connections
 - Method of wiring
 - Loose or self supporting
 - Covered or bare wire
 - Method of making connections
 - Soldered connections
 - Connection lugs or terminals
 - Washers
 - Workmanship
 - (2) Mechanical design and construction of supports for coils, condensers, etc.
- c. Photographs showing interior and exterior views of set and also any interesting units
- d. Cabinets
 - (1) Size
 - (2) Material
 - Solid or veneered
 - Kind—wood, metal or special composition
 - (3) Construction
 - Nailed, screwed, glued or jointed
 - (4) Covered or uncovered
 - (5) Finish
 - Stain, paint, varnish or special covering
 - Workmanship
- e. Panel
 - (1) Size
 - (2) Material
 - Wood, fiber or special composition
 - (3) Finish
 - Workmanship—edges and surface
 - Glossy or dull
 - Appearance
- f. Provisions for making connections
 - (1) Number of and connections required to place set in operation
 - (2) Simplicity of making connections
 - Location, number and arrangement of binding posts
 - (3) Binding posts
 - Type—design and construction
 - Removable—non-removable top
 - Small—medium—large
 - Metal or composition
 - Effectiveness of binding posts
- g. Tuning Arrangement
 - (1) Method of tuning—circuits used
 - Single circuit
 - Two circuit
 - Three circuit
 - Inductors used
 - Condensers used

\$12.50 Receiving Set with Constat Phones



RADIO Receiving Set for only **\$12.50** Including Constat Headphones

All the wonderful entertainment of the radio programs on this dandy set. Comprises double slide tuning coil, adjustable crystal detector, condenser and Constat headphones, all connected, ready for use. Best materials, carefully made, thoroughly tested. You couldn't possibly make this set yourself for less than \$15. You can get it complete for just \$12.50.

If Bought Separately { SET . . . \$7.00 } Outfit, { PHONES, \$8.00 } \$12.50

AERIAL OUTFIT
100 feet Stranded Copper Wire
6 Composition Insulators \$1.65

This wire sells anywhere for 85c and the insulators for at least \$1.50. Sent to your door, ready for making your aerial, for just \$1.65. Save time, labor and considerable money. Send postal or express money order. Every item guaranteed to give satisfaction.

BANISTER & POLLARD
208 MARKET ST., NEWARK, N. J.



FOUR SETS OF PHONES

25c will buy a set of Multiple Binding Post Connections (patent pending) which provide the only practical means of attaching as many as 4 pairs of telephone receivers to a pair of ordinary binding posts.

Dual connection set provides same connection in attaching Magnavox and outfit to storage battery.

Either set will be sent postpaid upon receipt of 25c in coin or stamps. Satisfaction guaranteed or money back.

PORTABLE WIRELESS TELEPHONE CO.
Dept. C, Commercial Bank Bldg.,
Stockton, California
Attractive Dealer's Proposition

JOBBERs and DEALERS



Variocouplers, Rotors, Winding Forms. Stators, in Genuine Mahogany.

Quick Deliveries. Write for prices.

ARTISTIC WOOD TURNING WORKS
519 No. Halsted St., Chicago, Ill.

TUBING FOR WIRELESS

SET OF 6 CARDBOARD TUBES IN HEAVY MAILING BOX FOR \$1.00

Postage Prepaid

Each Tube is 12" Long with 1/2" Wall. Sizes are 3", 3 1/2", 4", 4 1/2", 5", 5 1/2". Make a Vario-Coupler.

Genuine Ganaerite Crystal, Postpaid 50 cents.

RUTHERFORD SUPPLY HOUSE
P. O. BOX 125 RUTHERFORD, N. J.

Kwik-lite

WIRELESS "B" BATTERIES

**Are Quality Batteries
Different from the Ordinary**

They are made of Seamless Cells. Every one is carefully tested for noiseless operation before leaving the factory and is guaranteed to give longer life and better service than any other battery made.

Send today for prices and full particulars about this BETTER Battery.

THE USONA MANUFACTURING CO.
INCORPORATED
ONE HUDSON ST., NEW YORK CITY
TOLEDO SAN FRANCISCO

Storage Batteries for Radio Work

A good dependable battery at moderate cost, built in every detail of the best materials obtainable.

6 V., 40 A. H.,	\$ 10
6 V., 60 A. H.,	\$ 12
6 V., 100 A. H.,	\$ 16
6 V., 120 A. H.,	\$ 18

SEND FOR ONE
Mail orders promptly attended to

Bridgeport Storage Battery Company
235 Remington Street, Bridgeport, Conn.

COLDMOUNT

OUR NEW CRYSTAL

No heat used to mount this crystal.
Dealers write for proposition.

RADIALL ELECTRIC CO.
187 Passaic St., PASSAIC, N. J.

C JUST OUT! W

The C. W. MANUAL; only book of its kind on the market; tells you everything about C. W. and how to construct many types of radio telephone and telegraph Vacuum Tube Transmitters. Price, \$1.00 per copy, postpaid. 112 PAGES.

PACIFIC RADIO PUB. CO., Inc.
Pacific Bldg. San Francisco

It's easy, make your own INDOOR COIL AERIAL

Drawing, R. F. Amplifier circuit chart and tables giving proper number of turns to put on coil for any wavelength. Complete data covering 0 to 24,000 meters on two large sheets, \$1.00. Stamps not accepted.

C. A. DAVIS & CO.
2371 Champlain St., Wash., D. C.

- (2) Mechanical design and construction of apparatus
 - (a) Inductors
 - 1. Windings
 - Dimensions
 - Number of taps
 - Varnished, impregnated, etc.
 - Condition of windings
 - 2. Auxiliary parts
 - Coil supports, clamps, etc.
 - Rotor shafts, bushings, lead-in wires
 - (b) Condensers—variable or fixed
 - Size and number of plates
 - Method of supporting
 - Insulation used
 - Bushings and bearings
 - (c) Tuning controls
 - 1. Simplicity of adjustment
 - Number of controls
 - Convenience of controls
 - 2. Design and construction of
 - Knobs
 - Dials
 - Switch levers and knobs
 - Switch contacts
 - Other parts
 - h. Detector
 - (1) Type
 - Crystal or electron tube
 - (2) Design and construction
 - Crystal detector type
 - Kind of crystal
 - Method of mounting crystal
 - Method of adjusting
 - Ease of adjustment
 - Ruggedness of adjustment
 - Electron tube type
 - Type of tube to be used with set
 - Rheostat
 - Electron tube socket
 - (3) Electrical properties
 - Sensitivity
 - i. Diagram of connections of complete set
- B. Performance Tests**
- A comparison against a "laboratory standard receiving set" will be made under actual working conditions.
- a. Sensitivity. Audibility measurements on received radio telephone service will be made on the receiving set under test in comparison with a laboratory standard receiving set when both are tuned to receive signals from a given radio telephone transmitting station. "The performance rating" will then be given as the ratio (expressed in %) of the audibility reading of the test set to the reading of the standard. A "constant impedance" audibility meter will be used in the telephone receiver circuit. In developing this test method, several types of radiophone transmitting services will be received and the audibility readings recorded in each case. Later a satisfactory average type of transmission may be agreed upon.
- b. Sharpness of Tuning. Observations will be made of the region from which signals from the given transmitting station can be heard. The best way of expressing this "region" will be developed.
- c. Quality. The quality of music or speech received will be rated as good, medium or poor, together with a statement of the transmitting conditions existing during the time of the test and other facts observed such as those given below:
- Transmitting conditions
 - Subject
 - Male or female voice
 - Vocal or instrumental
 - Solo or company
 - Interference
 - Atmospheric
 - Station
 - Other facts observed
 - Rattles
 - Distortion
 - High vs. low notes
 - "Mushy" speech
 - Pure tone vs. chords

ELWOOD

RADIO HEADSETS

The seventeen years of practical experience in the making of telephones and receivers by this company assures you of good design and workmanship.

Elwood headsets meet the exacting demands of all purchasers of radio units and parts. Both receivers operate in unison, insuring clear, harmonious and uninterrupted reproduction. Our absolute guarantee of the ohmage capacity of these headsets is your safeguard.

Receivers have metal case, highly finished. Headbands have sanitary fabric covering, fully adjustable. Complete set packed in attractive carton.

We are also manufacturers of Binding Posts, Contact Points, Jacks and Plugs for Radio Work.

Elwood Electric Co., Inc.
Formerly Liddell Electric Mfg. Co.
2-4 Randall Avenue
BRIDGEPORT, CONN.

2000 ohm Headsets
\$7.00

3000 ohm Headsets
\$8.00

"LISEN-IN"
TRADE MARK

HEAD PHONES

The LISEN-IN Head Phone is the acme of perfection in a popular priced phone. It is of the two-pole type, 3,000 ohm capacity, thus offering a very high degree of resistance. Built for hard usage, but extremely sensitive. Adjustable to any shape head. Compact, but feather weight. Sanitary head band.

Our faith in LISEN-IN Head Phones is such that they are sold on a money back guarantee basis if they fail to give entire satisfaction.

The price is \$7.50, including two-headset receivers, sanitary head bands, and forked cords.

Ask your dealer for "LISEN-IN" PRODUCTS, manufactured by

NATIONAL RADIO COMPANY

**50 Union Square
NEW YORK, N. Y.**

*Live Wire Distributors
Write For Our Interesting
Proposition*

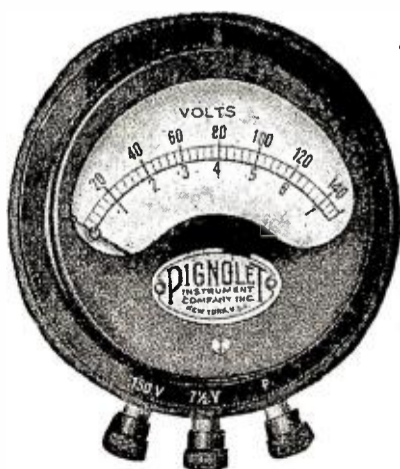

**Pignolet
RADIO
VOLT-
METER**

*One Instrument
Makes ALL
Tests*

*Write for
booklet with
suggestions*

for testing and adjusting Radio Sets.

Pignolet Instrument Co., Inc.
116 Liberty Street, New York, N.Y.

d. Wave length range. Measurement will be made of the wave length to which the receiving set tunes, using a dummy antenna equivalent to a single wire 30' high and 75' long.

C. Endurance Tests

a. Vibration test. Set will be clamped on a "vibration table" and notes made when various parts become loose.

b. Humidity test. Set will be placed in a humid atmosphere and the effect noted.

This is understood to be an outline drawn up with the desire for securing immediate results. Additions and improvements will be made in the methods by consultation and agreement.

In order to cooperate to the fullest extent, the National Retail Dry Goods Association approves the furnishing, by the Electrical Testing Laboratories to the Bureau of Standards, of all copies of the test reports. It is understood that these are entirely for the confidential use of the Bureau of Standards in connection with their research work on the development of methods for testing radio equipment.

It is understood that the Bureau of Standards will make measurements and calibrations of the laboratory standards used by the Electrical Testing Laboratories in their tests for the National Retail Dry Goods Association.

**STATION KDKA IS FIRST AMERICAN
RADIOPHONE STATION
HEARD SOUTH OF THE
EQUATOR**

KDKA, the radiophone broadcasting station of the Westinghouse Company, at East Pittsburgh, Pa., first station in the world to broadcast concerts on a schedule basis and pioneer in feature broadcasting, has established a new record. It has been the first of the American radiophone stations to be heard south of the Equator, having been picked up by a ship operator while in the port of Iquique, Chile.

The news that KDKA had been heard so far south—Iquique is approximately 4,200 miles from East Pittsburgh, Pa.—was conveyed in a letter written the radio division of the Westinghouse Company by Mr. Frank F. Reb, chief operator of the S. S. Santa Luisa, who caught the signals.

It is quite possible that other call letters, which Mr. Reb states in his letter sounded like WFD, were WJZ, the call of the Westinghouse Radio Corporation station at Newark, N. J. In any event Mr. Reb heard two Westinghouse stations, KDKA and WJZ, the same night, both of which are located over 4,000 miles from Chile.

KDKA, whose call letters are never mistaken, has made history in radio broadcasting. Starting as the pioneer every time a new feature was introduced it was usually KDKA, or one of the other Westinghouse stations, which was responsible. Now that it has been heard over such an enormous distance, some of the predictions made as to long distance phone transmitting may not look so improbable. It appears that every day opens some new possibility for the radiophone.

**"PEEP HOLES" FOR THE V. T.
FILAMENT**

The radio enthusiast who drills his own panels has doubtless found difficulty, as I did, in making a neat job of the small "peep holes" for the V. T. filament. An easy and cheap way of making an extremely neat and business-like job is to buy, or take from an old pair of boots, a few small eyelets. If worn shiny, they may be painted black again to match the panel. These are inserted in holes of the proper size, and will usually be found to fit firmly, and the result is all that could be desired.

Contributed by **E. L. JOHNSON.**

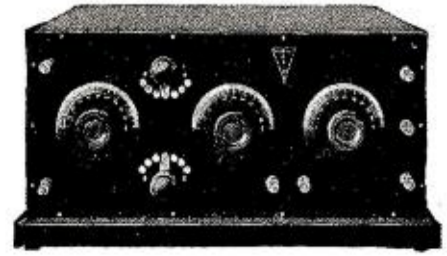

**HORNE
Radio Production**

is increasing by
tremendous strides.

**OVER
80**

important and
essential Radio
Devices

**DISTRIBUTED
NATIONALLY**

HORNE MFG. CO.

Sales and
Executive
Offices
30 Church St.
N. Y. City



Two
Factories
in
Jersey City
N. J.

**RADIO PANELS
Solid Silicon Fibre**

Panel Size, Inches	1/8" thick		3-16" thick		1/4" thick	
	Art No.	Price	Art No.	Price	Art No.	Price
6x7	P530	\$0.45	P531	\$0.60	P532	\$0.75
6x10 1/2	P540	.60	P541	.90	P542	1.10
6x14	P550	.90	P551	1.10	P552	1.30
7x18	P560	1.20	P561	1.70	P562	2.00
9x14	P570	1.20	P571	1.70	P572	2.00
12x14	P580	1.50	P581	2.75	P582	4.75

**RADIO CABINETS
Solid Silicon Fibre**

Assembled Ready to Use Panels Not Included

Panel Size	Inside Dimensions			Art No.	Price, Each
	High	Wide	Deep		
6x7"	5 1/2"	6 1/2"	7"	C640	\$2.50
6x10 1/2"	5 1/2"	10"	7"	C650	2.75
6x14"	5 1/2"	13 1/2"	7"	C660	3.25
7x18"	6 1/2"	17 1/2"	10"	C670	3.50
9x14"	8 1/2"	13 1/2"	10"	C680	4.50
12x14"	11 1/2"	13 1/2"	10"	C690	4.75

Parcel Post Prepaid East of Rockies

Radio Fibre Products Co.
250 Bergenline Ave., WEST HOBOKEN, N. J.

STEINER ELECTRIC CO.
115 N. Wells St., Chicago

RADIO SUPPLIES

Branch Store—5239 N. Clark St.
Wholesale and Retail

Genuine GANAERITE Crystals

Individually Tone Tested.
Most Sensitive Mineral Rectifier Developed.
Mounted Crystals, Postpaid, 50c.
Trade Discounts to Dealers and Clubs.
Now Delivering Promptly on Large Orders.

THE HARRIS LABORATORY
26 Cortlandt Street New York City.

The Armstrong Super-Regenerative Circuit

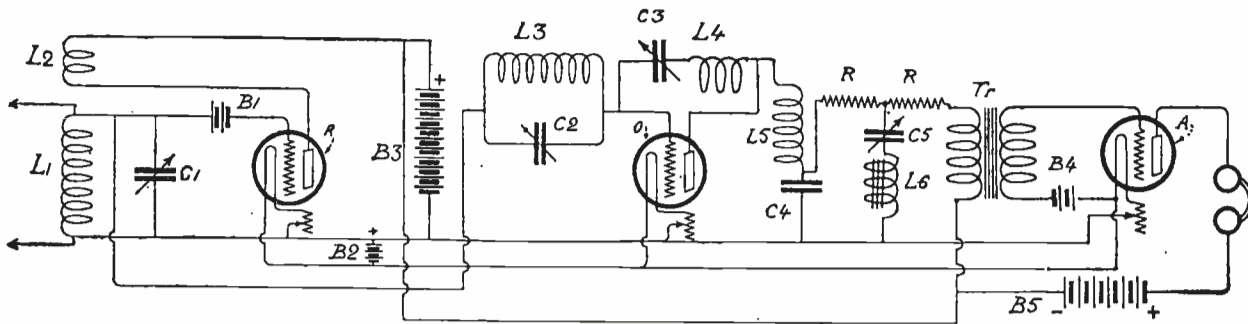

The Circuit Used by Major Armstrong in His Super-Regenerative Receiver as Demonstrated Before the Radio Club of America. The Constants are as Follows:

L1, L2, Variocoupler; C1, .001 M.F.; B1, 2 to 6 Volts; B2, 6 Volts; B3, 90 Volts; L3, 1250 D. L.; C2, .0025 M.F.; L4, 5 Milhenries; L5, 1500 D.L.; C3, .001 M.F.; C4, .005 M.F.; C5, .005 M.F.; R, R, 12,000 Ohms Each; L6, .1 Henry; Tr., Audio Frequency Amplifying Transformer; B4, 22½ Volts; B5, 200 Volts.

JUST before going to press, we were able to obtain the circuit shown above which was used by Major Armstrong in his demonstration of the super-regenerative receiver before the Radio Club of America at Columbia University. The coil L1, which is the primary of a short wave variocoupler, may be connected in series with the loop or in parallel, as shown. The secondary coil of the variocoupler L2 should be rewound with finer wire with about 90 turns. The grid battery of the first tube is variable from two to six volts and its value is best found by practice. The two duo-lateral coils in the grid and plate circuits of the second tube are not in inductive relation to each other. Any air core choke coil providing an inductance of five milhenries may be used for the coil L4.

C4, R, R, C5 and L6 form the filter circuit. R, R may be lavite resistances or choke coils

shunted by condensers may be substituted for them. The object of this filter circuit is to prevent the intermediate frequency produced by the oscillating tube from paralyzing the audio frequency amplifying tube. This filter circuit is therefore necessary when using audio frequency amplification with the super-regenerative circuit. More than one stage of audio frequency amplification is unnecessary as loud signals are obtained by the single stage. In this circuit the third tube is used to amplify at audio frequency. Two tubes alone may be used if desired and, in this case, the telephone should be connected in the position occupied by the primary of the audio frequency transformer. One side of the telephones should be connected to the positive of B3, as shown, while the other side of the telephones should be connected directly to L5, as the filter circuit is then not required.

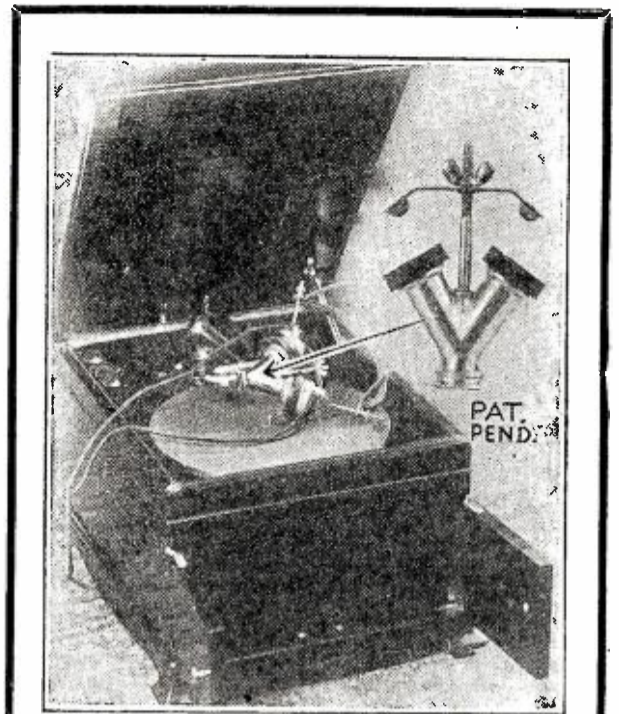

DUPLEX VICTROLA ATTACHMENT \$5.00

Make a first class loud speaker of your head phones and Victrola with a DUPLEX. Highly polished aluminum and nickel plate. Can fit any make of machine. If your dealer does not have DUPLEX, state make of talking machine and we will send post paid on receipt of price.

Manufactured by

W. B. McMASTERS, Wheeling, W. Va.

RAC-AUDION

AUDION \$5.00
5 TIMES THE AMPLIFICATION OF THE ORDINARY TUBE

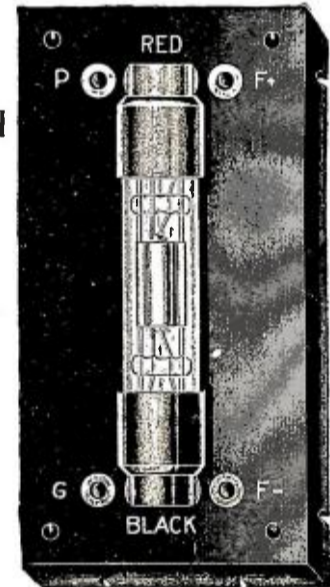

RECEPTACLE \$1.00
WRITE FOR INFORMATION AND DIAGRAM USING RAC CHOKE COILS

4 V-Fil 0.8 Ampere 60-Plate
New Jersey Radio Equip. & Install. Co.
120 BIDWELL AVE. JERSEY CITY, N. J.

Why Should I Use a

Weston

Filament Voltmeter

On My Receiving Set?

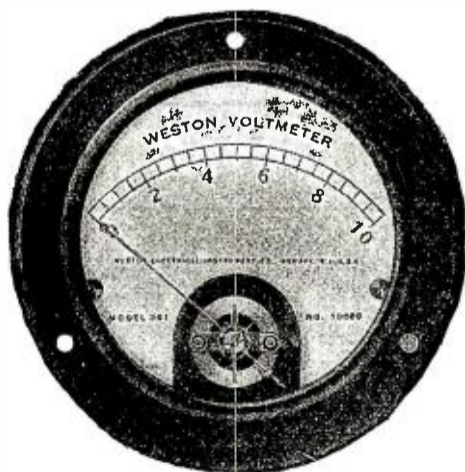

Model 301

Buy it from your dealer, or from us direct if he cannot supply you. Write for Radio Circular J.

Here's the Answer:

- 1.—It simplifies tuning by eliminating guesswork as to tube adjustments
- 2.—Filament voltage control increases the life of tube from two to three times.
- 3.—The Weston Filament Voltmeter is accurate and can be relied upon for duplication of results.

All this Means
Better Reception

WESTON ELECTRICAL INSTRUMENT CO.

173 Weston Avenue, Newark, N. J.

Branches in the Large Cities

RADIO BLUE PRINTS

With separate printed instructions, giving all details of construction for making every modern receiver part from raw material; nothing omitted. 24 fine, clear blue prints. Save cost of the whole set when you make the loud talker. Send stamp for full particulars.

THE PLAN BUREAU

1929 McCausland Ave., ST. LOUIS, MO.

RADIO FOR THE NATION

Stores in five large cities enable this organization to supply radio equipment, both wholesale and retail, with the greatest speed and economy.

20th Century Radio Corporation

565 Fifth Avenue, New York City
Straus Bldg., Suite 710

Stores in Norwalk, Conn., Detroit, Mich., Newark, N. J., Brooklyn, N. Y., White Plains, N. Y.

OPPORTUNITY AD-LETS

Follow these advertisements every month. Reliable advertisers from all over the country offer their most attractive specials in these columns.

Classified advertising rate fifteen cents a word for each insertion. Ten per cent discount for 6 issues, 20 per cent discount for 12 issues. Name and address must be included at the above rate. Cash should accompany all classified advertisements unless placed by an accredited advertising agency. No advertisement for less than 10 words accepted.

Objectionable or misleading advertisements not accepted. Advertisements for the October issue must reach us not later than August 1st.

THE CIRCULATION OF RADIO NEWS IS OVER 235,000

EXPERIMENTER PUBLISHING CO., INC., 53 Park Place, New York, N. Y.

Aeronautics

Model Aeroplanes That Fly.—Buy your complete outfit, scale drawings, fittings, compressed air motors and all-best model aeroplane supplies from the Wading River Manufacturing Co., Established 1900. Our new 52-page catalog illustrated, 24 latest models and designs. Send 5c for your copy. Wading River Manufacturing Co., 672 J, Broadway, Brooklyn, New York.

Agents Wanted

Wireless Telegraph Stocks for Sale. Radio Telephone Stocks for sale. Agent and Stock Salesmen Wanted. If it is a Wireless Telegraph or a Radio Telephone Stock, and if it is on the market—We have it—We buy it—We sell it—We trade in it—and we can tell you all about it. A few hundred dollars invested in Wireless, the right kind of stock will produce fortunes in a decade, beyond your fondest expectations. Stock salesmen can make good money now that the boom is on. Cut this ad out for future reference. P. C. Kullman & Co., The Wireless Brokerage House, 110-116 Nassau St., New York City.

\$75.00 to \$150.00 Weekly. Free samples. Lowest priced gold window letters for stores, offices and autos. Anybody can do it. Large demand. Exclusive territory. Acme Letter Co., 2800M Congress, Chicago.

We Wish Representatives in every community to secure subscriptions for Radio News, Science and Invention, and Practical Electrics. This is a wonderful opportunity for Amateur Radio Enthusiasts to make big money quickly. Write Experimenter Publishing Co., Inc., 53 Park Place, New York City.

Big Money and fast sales. Every owner buys gold initials for his auto. You charge \$1.50; make \$1.35. Ten orders daily easy. Write for particulars and free samples. American Monogram Co., Dept. 133, East Orange, N. J.

Amateur Agents Wanted in every city and town to sell radio apparatus. A few stocking agencies still open. Delfelco, 12 Meeting Street, Pawtucket, R. I.

Agents Wanted in every city and town to sell standard radio apparatus. Attractive discounts given. If interested, write us at once stating age and radio experience. Wilmington Electrical Specialty Co., Inc., 912 Orange St., Wilmington, Delaware.

Automobiles

Automobile Mechanics, Owners, Garagemen, Repairmen, send for free copy America's Popular Motor Magazine. Contains helpful instructive information on overhauling, ignition wiring, carburetors, batteries, etc. Automobile Digest, 9528 Butler Bldg., Cincinnati.

Batteries

Burgess "B" Batteries—Large stock. Ready for immediate shipment. Absolutely noiseless. Just the thing for amplifiers. Long life. Large size 221v. tapped. Special price, \$2.75. Prepaid. Order now. Dept. R, The Practical Supply Co., Binghamton, N. Y.

Business Opportunities

Radio and Other Patents that need financing—10-in-one Refillable Snap Fuse Plug, Refillable Pull Out Fuse Plug, Refillable Cartridge Fuse, Snap Lever Lamp Socket, attachment Plug, New Radio Binding Post, Telephone Headset, Telephone-Horn Adapter, Instantaneous Near and Remote Signalling Flow and Level Indicator. For details address W. C. Floring, 906 Amsterdam Ave., New York.

Men—Make money in spare time mailing letters, unusual opportunity offered. Send stamped addressed reply envelope. R. Normande, 147 W. 23d St., New York.

Chemistry

Learn Chemistry at Home—Dr. T. O'Connor Sloane, noted educator and scientific authority, will teach you. Our home study correspondence course fits you to take a position as chemist. See our full page ad on page 374 of this issue. Chemical Institute of New York, 140 Liberty Street, New York City.

Correspondence Courses

Correspondence Courses at less than half original prices. Any school; any subject for men or women. Bulletin 1074 free. Courses bought. Instruction Correspondence Exchange, 1966 Broadway, New York.

Dollars Saved—Used correspondence courses of all kinds sold, rented and exchanged. List free. (Courses bought.) Lee Mountain, Pisgah, Alabama.

Electrical Supplies and Appliances

Electric Tattooing Outfits, Illustrated Catalogue, 10c. Waters Mfg., 1050 Randolph, Detroit.

For Sale: Shelco Transformer 2-7 Amp. primary, 2500-1500 secondary \$25.00. 200 Watt step down transformer 3-24 Volts \$7.50. 20 Ohm Relay and Giant Sounder, both \$6.00. 4 Magnet Testing Ringer, \$3.00. Universal Motor, 1/10 H. P. Aluminum Nausing, \$7.50. Edison Dick No. 75 Mimeograph, \$20.00. Victor Stereopticon 5 Amp. Arc and Rheostat, \$15.00. 14 Amp. Hot Water Faucet, \$5.00. All good condition. Geo. Schulz, Calumet, Mich.

Books

Radioman's Handbook. Simply explains crystal and vacuum tube receivers, stages of amplification, gives symbols, defines terms, everyday formulas, and other helpful information. Excellent ready reference book for the amateur and layman. Price, 75 cents. Radiophone Service Bureau, 1431h Clifton Street N. W., Washington, D. C.

New Book. Title Efficient Radio Sets, 50c. T. Youngblood, 16 Grove, Charlotte, N. C.

Radio Building Books, 25c. Amateur Electrician, 10c. Toyman Books, 10c—64 pages each. 150 kinds mechanical puzzles, leader and catalog, 10c. Western Puzzle Works, 15, St. Paul, Minn.

Electricians' Examinations: Book of questions and answers with diagrams, symbols, tables, notes and formulas for preparation for license. \$1.25 by mail. Aaron Shapiro, 132 West 24th St., New York.

We Buy and Sell back issues of Radio Amateur News and Electrical Experimenter. Boston Magazine Exchange, 109 Mountfort St., Boston, Mass

How to Make Wireless Receiving Apparatus. 100 pages—90 illustrations. Only strictly modern radio apparatus are described in this book and the illustrations and descriptions are so clear and simple that no trouble will be experienced in making the instruments. Paper covered. 35c postpaid. Experimenter Publishing Co., Book Dept., 53 Park Place, New York City.

How to Make Wireless Sending Apparatus. 100 pages—88 illustrations. Written and published entirely for the wireless enthusiast who wants to make his own radio apparatus. Contains more information on "how to make it" than any other book we know of. Paper bound, 35c. postpaid. Experimenter Publishing Co., Book Dept., 53 Park Place, New York City.

Wireless Course in 20 Lessons. By S. Gernsback, A. Lescarbours and H. W. Secor, E. E. Tells you everything you want to know about "Wireless"—theory, practice and history. A clear, concise course on every phase of this subject. 160 pages—350 illustrations, 30 tables. Stiff cloth cover, \$1.75 postpaid. Experimenter Publishing Co., Book Dept., 53 Park Place, New York.

Experimental Electricity Course in 20 Lessons. By S. Gernsback and H. W. Secor, E. E. A course of the theory and practice of Electricity for the Experimenter. Every phase of experimental electricity is treated comprehensively in plain English. New experiments are described and explained and nearly every application of Electricity in modern life is given. 160 pages—400 illustrations. Flexible cloth cover, 75c. postpaid. Stiff cloth cover, \$1.25 postpaid. Experimenter Publishing Co., Book Dept., 53 Park Place, New York City.

The How and Why of Radio Apparatus, by H. W. Secor, E. E. This newest book on radio matters fulfills a distinct gap in wireless literature in that, while the treatment is made as understandable and as free from mathematics as possible, it at the same time incorporates a wealth of technique and instruction for the Radio Amateur—the Radio Operator—the Installation and Designing Expert—as well as teachers and students of the subject in general. A very broad field has been covered by the author, at the same time giving a great deal of information not found in other text books. If you are engaged in any branch of the Radio or allied arts at all you will surely need this latest contribution to radio literature, which is destined to be found on every radio man's book shelf before long. A glance at the following list of chapters gives but a very scant idea of the extensive and useful radio knowledge provided in its text: The Induction Coil; The Alternating Current Transformer; Radio Transmitting Condensers; The Spark Gaps; Radio-Transmitting Inductances; Radio Receiving Tuners; Radio Receiving Condensers; Detectors; Telephone Receivers; Radio Amplifiers; Construction of a Direct Reading Wavemeter and Decimeter; Antenna Construction; The Calculation and Measurement of Inductances; Appendix containing very useful tables, covering all subjects treated in this very unusual book. This newest of Radio Works, cloth bound in Vellum de Luxe, Gold Stamped and Hand Sewed, has 160 pages. Size of book 6x9 inches. The How and Why of Radio Apparatus. Postpaid, \$1.75. Experimenter Publishing Co., Book Dept., 53 Park Place, New York City.

Help Wanted

Electrical Sales Engineer, familiar with Radio, with equipped office, Phila., Pa., open for connection with manufacturer or distributor. H. W. Marks, 1420 Fairmount Avenue, Phila., Pa.

Earn \$25 Weekly, spare time, writing for newspapers, magazines. Experience unnecessary; details free. Press Syndicate, 5665, St. Louis, Mo.

Be a Mirror Expert, \$3-\$10 a day; spare time home at first; no capital; we train, start you making and silvering mirrors. French method. Free prospectus. W. R. Derr Pres, 26 McKinley St., Baldwin, N. Y.

Detectives Earn Big Money. Excellent opportunity. Travel. Experience unnecessary. Particulars free. Write, American Detective System, 1968 Broadway, N. Y.

Insects Wanted

Spend Spring, Summer, Fall, gathering butterflies, insects. I buy hundreds for collections. Send 25c (not stamps) for illustrated prospectus. Sinclair, Dept. 33, Ocean Park, California.

Exchange

Bargain, Complete Receiver, has distance records, \$75. Ideal for concerts and amateurs. Schrader, Rockland Ave., Yonkers, N. Y.

Wanted, Small Radiophone Complete—Box 307, Mar-anna, Fla.

Omnigraph Wanted—R. W. Carr, 237 W. Hulsach Ave., San Antonio, Texas.

For Sale—Mahogany cabinets, knockdown, 6x6x8 deep, \$2.00. 6x12x8 deep, \$2.50. Wood variometer parts, \$1.40. Brass, 50c. Variocoupler rotor, 40c. Other parts listed. Edward Edstrom, 5838 Dakin St., Chicago.

Sell: Amrad Tuner Detector and two step like new. For detail write, B. B. Guyton, Butler, Mo.

Sell: Loose Coupler, Phones, Detector Panels. Arthur Houllihan, Woodlawn Ave., Ansonia, Conn.

For Sale: 9 BLW's ½ K. W. Transmitter. Is in perfect condition. Very efficient, \$38. Jack Jones, R.F.D. No. 2, Liberty, Missouri.

Duck Regenerative Receiving Set including Detector Tube and B Battery, \$45. Two-step Amplifier including Tubes, \$33. Federal Pleiophone, \$10. Send money order or certified check. Jas. L. Ivory, Millbury, Mass.

For Sale—\$45 Receiving Cabinet \$22, slightly used, 2-step Amplifier in cabinet, new, \$27. Detector in cabinet, new, \$7; Electron Relay, \$3.50. All apparatus in good condition. Will ship C.O.D. Wayne Mason, South Brownsville, Penna.

Sell—15000 meter long Wave Coupler, \$10; cost \$30. A1 condition. George Miller, R. F. D. No 1, Steubenville, Ohio.

For Sale—Two Radio Concert Receivers, Regenerative with Detector and two stage Amplifier Guaranteed as efficient as sets double the price. Sixty dollars each. J. Nauta, 141 Butler St., Paterson, New Jersey.

For Sale or Trade for Wireless apparatus one thirty-two hi power fore arm action Remington rifle, A1 condition. S. T. Northcott, 1204 N. Birney, Bay City, Mich.

28 Dollars 32-caliber Spanish Automatic—Brand new for Radio equipment. Leo Pruvost, Roanoke, Ill.

Special Radio Storage Batteries, Edison. Lead all sizes. Radio Battery Service Station, 41 Bryant St., Malden, Mass. I.K.M.

For Sale—1 K.W. Transmitting Marble Panel Set. Inquire. Francis Shannahan, 108 South St., Waterbury, Conn.

For Sale—No. 2 Jr. Omnigraph, \$7. Harry Whittle, 347 Kenlin St., Chester, Pa.

Trade—New \$55 Ranger Bicycle never used. Want Magnavox. C. Gimmy, 13503 Emily St., E. Cleveland, Ohio.

Amateur Agents wanted in every city and town to sell radio apparatus. A few stocking agencies still open. Delfelco, 12 Meeting Street, Pawtucket, R. I.

New and Slightly Used Radio Sets Cheap. Globe Radio Supply Co., Box 23, Dorchester, Mass.

Have Complete Single Circuit Receiver, Detector and two stage Amplifier, including Phones and all Bulbs, everything in fine oak case. No Batteries. New. Sacrifice for \$130. Just right for long distance radiophone reception. John Mooney, Jr., 2903 Girard Ave., Phila., Pa.

Zwibel and Shafer Vulcanizers complete. Cost \$40. Ford Motor Stand, \$16. Magic Rim Tool, \$20. Wheel Puller, \$15. Sell or exchange for Radio Broadcasting equipment. P. O. Box 251, Jermyn, Pa.

Bargain—One 15-inch Lyon and Healy Snare Drum. Practically new. Only \$15. John Sellers, 752 So. Bayou St., Mobile, Ala.

Good \$25 Navy Type Coupler, 7½ x 21½, only \$12. Ford coils \$1.45. New 9½ x 6½ duplicator, \$1.75, include postage. James Foote, Anita, Iowa.

For Men

Blades Sharpened One Edge, 2c. Double, 3c. D. Edgeco. Glen Cove, N. Y.

Health

Pyrorrhea (Rigg's disease—bleeding or swollen gums)— hundreds have been helped by "Pyrordent" the successful home pyrorrhea treatment. Purifying, healing, preventative. Full month's treatment, consisting of a very beneficial massage paste and an antiseptic tooth-cleansing paste to be used in place of your ordinary dentifrice, together with full directions for treatment. \$1 postpaid. Or write for free booklet "R." Pyorrident Mfg. Co., 439 Seventh St., Brooklyn, N. Y.

Tobacco or Snuff Habit Cured or no pay; \$1 if cured. Remedy sent on trial. Superba Co., S.B., Baltimore, Md.

Instruction

Learn Chemistry at Home—Dr. T. O'Connor Sloane, noted educator and scientific authority, will teach you. Our home study correspondence course fits you to take a position as chemist. See our full page ad on page 374 of this issue. Chemical Institute of New York, 140 Liberty Street, New York City.

Learn By Listening: We teach Hawaiian Guitar, Using Our Phonograph Records. Send for particulars. Roach-Frankland, 307 East Fourth St., Cincinnati, Ohio.

Mouth-Organ Instructor, 25c. Learn in one hour. Elsea Co., Bowling Green, Ohio.

Manufacturing

Punch Press Work, enameling, printing on metal and celluloid. Samples free. Gilson Compay, Niles, Mich.

MANHOOD-

Make Your Face Show It



Every real man wants the clear, rugged, ruddy face of a real he-man; the healthy, clean skin and alert expression that comes from a vigorous life in the open air. All men want it—all women admire it. You can have it.

"STAG"

A Man's Cream For a Man's Face

—is a true facial invigorator and tonic prepared for men. Two minutes' use brings the red blood tingling to the surface, removes that oily, sallow appearance and leaves the skin clean, clear, firm and with healthy color. It invigorates and hardens the facial muscles and promotes an alert, forceful expression. A sixty-day treatment—with money-back guarantee—will be sent to you for a dollar bill.

Manhood Commands Admiration

Men and women all admire the man whose face shows the clean vigor of perfect health. Stag is made for you men who want to be one of those ruddy, forceful, hard-hitting fellows who are always so popular. Send your name, address and a dollar and it will come to you by return mail—fully guaranteed.

Stag Laboratories 1263 Park Place, West Dept. 816, Detroit, Mich.

Clear-Tone FOR PIMPLES

Your skin can be quickly cleared of Pimples, Blackheads, Acne Eruptions on the face or body—Enlarged Pores, Oily or Shiny Skin. CLEAR-TONE has been Tried, Tested and Proven its merits in over 100,000 test cases.

FREE WRITE TODAY for my Free Booklet—"A CLEAR-TONE SKIN"—telling how I cured myself after being afflicted fifteen years.

E. S. GIVENS, 103 Chemical Bldg., Kansas City, Mo.

FOR OUTDOORS

- Army Shelter Tent.....\$ 1.45
- U.S.A. 16x16 ft. Pyramidal Tent.....\$16.85
- New Khaki Riding Breeches.....\$ 2.45
- New U.S.A. Khaki Shirt.....\$.99
- New Canvas Leggings.....\$.47
- New O. D. Wool Shirt.....\$ 2.65
- New Zeiss Field Glasses.....\$10.85
- New Prism Binoculars, 8 power.....\$25.00
- New Army Shoes.....\$ 4.45
- New Leather Puttees.....\$ 3.45
- New Automatics, 32 & 25 Caliber.....\$ 8.95
- Army Folding Cot.....\$ 2.45
- O. D. Wool Blanket.....\$ 2.25

Add postage to above prices. Money promptly refunded if not satisfied.

ATLANTIC STORES
472 Koplín Building
ATLANTA, GEORGIA

CUSTOM TAILOR MADE TO FIT YOUR INDIVIDUAL CAR

Made in our custom shops after your order is received. We ship ordinarily in 2 or 3 days. Perfect fit guaranteed when correct name, year and model of car is given. You can easily apply it yourself.

\$4.40 and up
Parcels Post Paid

We furnish instructions and all necessary tacks, welts and fasteners. Our Catalog No. 10 with samples is free for the asking.

LIBERTY TOP & TIRE CO., Dept. R-1, Cincinnati, O.

Wireless (Continued)

Attention!—50 Vacuum tube hook-ups. The greatest collection of vacuum tube circuits ever brought under two covers at such insignificant cost. These diagrams will be found in the great "Rasco" catalog, which contains raw materials and parts in a greater profusion than any other catalog. 15c in stamps, or coin, will bring the catalog to you. Radio Specialty Co., 96-98 Park Place, N. Y.

Boys! Don't Overlook This. The "Rasco" Baby Detector. Greatest detector ever brought out with molded base. Fully adjustable. See former advertisements in this publication, or our catalog. Detector with Galena Crystal, complete 50c, the same detector with Radiocite Crystal, 75c prepaid. Send for yours today. Radio Specialty Company, 96-98 Park Place, New York City.

Build Your Own Radio Receiving Set, and receive daily concerts, market reports, etc. Complete directions—with drawings and diagrams—sent postpaid for 25c. Send coin or money order today. Special offers on complete Radio sets and parts. Address Dept. R., Bassett Radio Supply Co., Roseville Station, Newark, N. J.

Ozarka (tested) Galena Crystals insure strong signals and loud speech. Guaranteed sensitive. For sale by Radio dealers everywhere, or sent prepaid, for 15c (coin). Dealers, jobbers and manufacturers, write for prices. Ozarka Mineral Company, Lawrence, Kansas.

Amateurs—Build your own Electrolytic Storage Battery Charger. Plates and complete instructions, \$1.00. Descriptive Circular free. Peerless Electrical Parts Co., 105 Harris St., Rochester, N. Y.

Radio Tubes—Orders filled same day as received. Detectors (No. 200), \$4.00; Amplifiers (No. 201), \$5.00. Cash with order. 5 per cent discount on orders \$50 or over. Radio Tube Distributing Co., 1437 1st Ave., N. Y. C., N. Y.

Hear Plainer and Louder, increase the range of your crystal sets, eliminate the expense of having dear V.T. and attachments. Send for this wonder circuit diagram. Necessary apparatus will cost less than \$1.00. Roy Radio Co., 216 17th St., Brooklyn, N. Y.

Variometers and Variocouplers, \$5. Immediate deliveries. Simplex Variometers and Variocouplers, \$6; Pada Rheostats, \$1.00; Dials, \$1.00; Moulded Sockets, \$1.00; complete stock of Radiotrons and Standard Sets including Westinghouse and Grebe in stock at standard prices. L. W. Shollenberger Co., North Second St., Pottsville, Pa.

Complete Radio Antenna Outfit; 125 ft. stranded wire, porcelain insulators, screw eyes, 50-ft. lead-in wire, 3 porcelain knobs, entrance insulator, lightning arrester, 30-ft. ground wire, ground clamp, dozen insulated staples and complete installation directions. Price, \$5.50. Write for list of complete radio supplies. C. W. Thompson Company, Mattoon, Illinois.

Wireless Telephone, we hear Chicago 900 miles fine on a good night. Do you? There is radio music in the air each evening, and the living voices of the artists can be reproduced in your own home and enjoyed by you and your friends. Are you satisfied with your receiving set or would you like to build one that will receive over 6,000 miles on a single bulb and quit experimenting? One that will be equal to any regardless of claims and price—with which you can read Honolulu, California, German, South American, French and English stations and practically all of the high powered foreign and domestic stations, as well as amateur stations as far west as New Mexico. Anyone can assemble this outfit and wire it up and the remarkable ranges that may be obtained will surprise you. Why not make a set up to date and efficient? Don't experiment with unknown circuits. We will promptly mail you our simple diagram of a complete short and long wave receiver, 175 to 20,000 meters, together with complete instructions for wiring and assembling, price of each part and where they can be bought, leaving nothing to guess about, on receipt of fifty cents in coin or stamps. Here is a diagram no amateur can be without. Build your own Wireless Telephone receiver. Virginia Novelty Company, Martinsburg, West Va.

Radio Fans: Send for our catalog of Electrical, Radio and Mechanical books, includes radio outfits and amplifying transformers. Prices reasonable. A. C. Urie & Co., 333 W. Manhattan Blvd., Toledo, Ohio.

Radio Crystals, tube galena, steel galena and Pyrite crystals. These minerals tested and guaranteed extra sensitive, ounce, 25c, pound, \$2.00. Special prices to dealers. Western Research Corp., 516 18th St., Denver, Colo.

Galena, Silicon, Carborundum, Pyrite, crystals mounted in special metal, tested, guaranteed, 35c each, 3 for \$1 postpaid. Moser Radio Products, 132 Nassau St., N. Y. City.

Transmitting Parts to be sold below cost. Three essential parts of excellent Transmitting Set, in perfect condition and excellent working order, to be sold as a whole or separately. Motor Generator Set with synchronous disc discharge—\$80.00; Switch Board—\$25.00; Transformer—2KW 240 cycle—\$20.00. Only one of each item. Write at once for details if interested. Doubleday-Hill Electric Co., 719 Liberty Ave., Pittsburgh, Pa.

Climax Radio Frequency amplifying transformers, 180 to 500 meters unassembled, with instructions and wiring diagram, \$1.50 each. Assembled, \$2.50 each. International variable condensers, very best construction, .0005, \$3.25; .001, \$3.50; .002 Mfd., \$4.25, each with 3-inch dial and knob. Large size variometers and variocouplers, with 3-inch moulded dial and knob, assembled, \$3.75 each. 3 for \$10. Lot of inductance coils (honeycomb), new, with plugs, sizes between 130 to 1,400 meters, 75c each; between 1,400 to 4,000 meters, \$1 each. Satisfaction guaranteed. Add postage. Circulares free. H. V. Butterworth, 331 Quincy Street, Brooklyn, N. Y.

Aerial Wire—Peerless No. 14 pure solid copper. Highest grade obtainable. Enormous stock. Immediate shipment. Put up in 100, 250 and 500-foot rolls at 50c, \$1.25, \$2.50, respectively. Order now. Dept. R, The Practical Supply Co., Binghamton, N. Y.

How to Make Wireless Receiving Apparatus. 100 pages—90 illustrations. Only strictly modern radio apparatus are described in this book and the illustrations and descriptions are so clear and simple that no trouble will be experienced in making the instruments. Paper covered, 35c postpaid. Experimenter Publishing Co., Book Dept., 53 Park Place, New York City.

How to Make Wireless Sending Apparatus.—100 pages—88 illustrations. Written and published entirely for the wireless enthusiast who wants to make his own radio apparatus. Contains more information on "how to make it" than any other book we know of. Paper bound, 35c, postpaid. Experimenter Publishing Co., Book Dept., 53 Park Place, New York City.

NEW AND POPULAR BOOKS

DESIGN AND CONSTRUCTION OF AUDION AMPLIFYING TRANSFORMERS

Radio and Audio Frequency Type

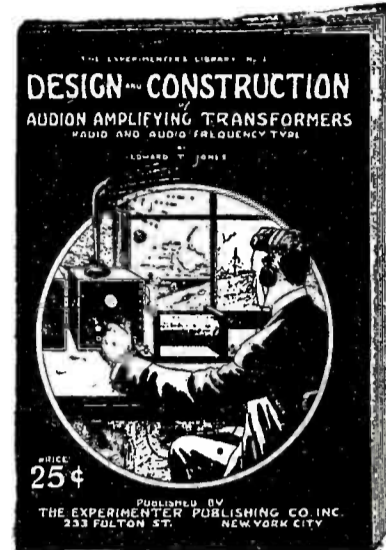

This latest and important book by Mr. Edward T. Jones, late Associate Editor of Radio News, will be of great interest to all radio amateurs throughout the land. The transformers shown in these books have never been described in print before, and have usually been considered a manufacturer's secret. Anyone who has several vacuum tubes cannot afford to do without this book because it will enable him to build the necessary amplifying transformers very readily. The designs are very simple and rugged, and anybody can make them without trouble.

The book is printed on good paper and has an attractive cover in two colors. Paper bound. Size 5x7 in. Contains many illustrations, diagrams and working data necessary to build the transformers.

Price, Postpaid 25c.

TWO REMARKABLE BOOKS

Book No. 1 contains 100 pages, size 7 x 5 in., and 88 illustrations.

Book No. 1—How to Make Wireless Sending Apparatus. 35c. Postpaid.

Book No. 2 contains 100 pages, size 7x5 in., and 90 illustrations.

Book No. 2—How to Make Wireless Receiving Apparatus. 35c. Postpaid.

Written and published entirely for the wireless enthusiast who wants



to make his own radio apparatus. Only strictly modern instruments are described and the illustrations and descriptions are so clear and simple that no trouble will be experienced in making the instruments.

THE EXPERIMENTER PUBLISHING CO.

Book Dept., 53 Park Place, New York

These Books Are For Sale Also At the Following Dealers

- Amer. Technical App. Co., 235 Fulton St., N. Y. C.
- Baker Taylor Co., 354 Fourth Ave., N. Y. C.
- Benwood Co., Inc., 3424 Olive St., St. Louis, Mo.
- Marconi Wireless Tel. Co., Montreal, Canada
- E. P. Noll Co., 21 N. 7th, Phila., Pa.
- Continental Radio Supply Corp., 6 Warren St., N. Y. C.
- F. S. Katzenback, 35 E. State St., Trenton, N. J.
- McDevitt & Wilson, 30 Church St., N. Y. C.
- R. H. Macy Co., New York City
- Manhattan Elec. Supply, 17 Park Place, N. Y. C.
- John Wanamaker, New York, N. Y.
- Geo. Parezo & Co., Washington, D. C.
- Southern Elec. Co., San Diego, Calif.

OUR MID-SUMMER OFFER

A Set of Blue Prints and Illustrated Directions for Making Your Own Radio



Absolutely Free



The Real Radio Season begins with the month of September and you can have your own plant, built by yourself, in good working order before that time.

Thousands of amateurs who knew nothing whatever of the principles of the Radiophone have built their own plants from these plans, and you can do likewise.

Radio News and Science and Invention are acknowledged everywhere to be the two principal Radio magazines published. They are issued at different times in the month and a subscriber to both actually receives a Radio magazine about every two weeks. And very many Radio enthusiasts subscribe for both.

Space will not permit our recounting here the wonderful articles that are to appear this fall—but you will want them, every one. Therefore we will send you absolutely free of charge the two sets of Plans and Illustrated Directions as described below if you will send us your subscription to both magazines for one year (12 issues each). The yearly subscription price to each magazine is \$2.50 with 50 cents additional for Canada.

PLANS No. 1

Illustrations and Directions "How to Make a Short Wave Regenerative Receiver"

This is the popular "Receiving" set easily made by the amateur.

PLANS No. 2

How to Make Detector and Amplifier Units

These blue prints and directions are exactly what you want if you wish to add additional units to your small plant—to extend your receiving distance and to strengthen the sound waves received.

REMEMBER, by subscribing for one year you not only obtain the above plans and directions free, but you also obtain the magazines at less than the news stand price and you are sure to receive them regularly and at the earliest moment.

EXPERIMENTER PUBLISHING COMPANY

53 Park Place

New York

SPECIAL MID-SUMMER OFFER

Experimenter Pub. Co., 53 Park Pl., New York City:

Gentlemen—Enclosed please find \$5.00 for which please enter my subscription to RADIO NEWS and SCIENCE AND INVENTION each for one year (12 issues each) and also send me free of cost both sets of Plans, Blue Prints and Directions as described in your special offer.

Name.....Street.....

City.....State.....



"Above them all"

TRESKO

Seven Years in Radio

—Think What That Means!

TRESKO

SECTIONAL UNIVERSAL

Licensed Under Armstrong U. S. Patent No. 1,113,149

The Tresco Tuners were among the first ever made under the Armstrong Patent. They are found in all parts of the world, giving satisfactory service. The sectional idea is original with us.

The instruments are identically the same as those we have been manufacturing for seven years—but we have made their casings on the plan of the sectional bookcase—each a separate unit which, when put together with a top and base, forms one complete section.

The set consists of three units :

1. Tuner and Detector.
2. Two-Stage Amplifier.
3. Case for "A" Storage Battery.

The sections are of oak, finished in French gray, making an extremely attractive piece of furniture—something you will be proud to have in your home, beside your phonograph or piano. No wires or battery on the floor.

PRICES

Tuner and Detector Unit without vacuum tube, head set or "B" Battery	\$ 50.00
Two-Step Amplifier Unit without vacuum tubes or "B" Battery	35.00
"A" Battery Unit for holding "A" Battery	9.50
Top and Bottom, which, when added to the three other units, make a complete section all in one. Each, \$5.00; both	10.00
Complete set of five units—Total	\$104.50

The units when assembled make a cabinet 40 inches wide, 15 inches high and 10 inches deep.

We do not furnish vacuum tubes, batteries or head sets.

TRESKO SECTIONAL UNIVERSALS are being supplied to dealers and jobbers just as fast as possible. Order from your local dealer. If he cannot supply you, we will fill your order upon receipt of prices as given.

Dealers and jobbers are rapidly finding out that TRESKO is one of the very few manufacturers who are actually in position to take care of large volume orders for immediate shipment. Liberal discounts are given to jobbers and dealers for quantity orders. We do not furnish vacuum tubes, batteries or loud speakers.

TRESKO

RADIO

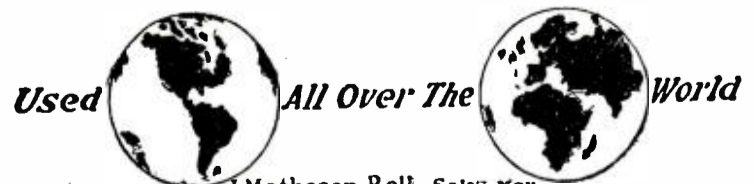

Davenport, J. Matheson Bell, Sales Mgr. Iowa, U.S.A.

Let These Guides

Solve Your Problems

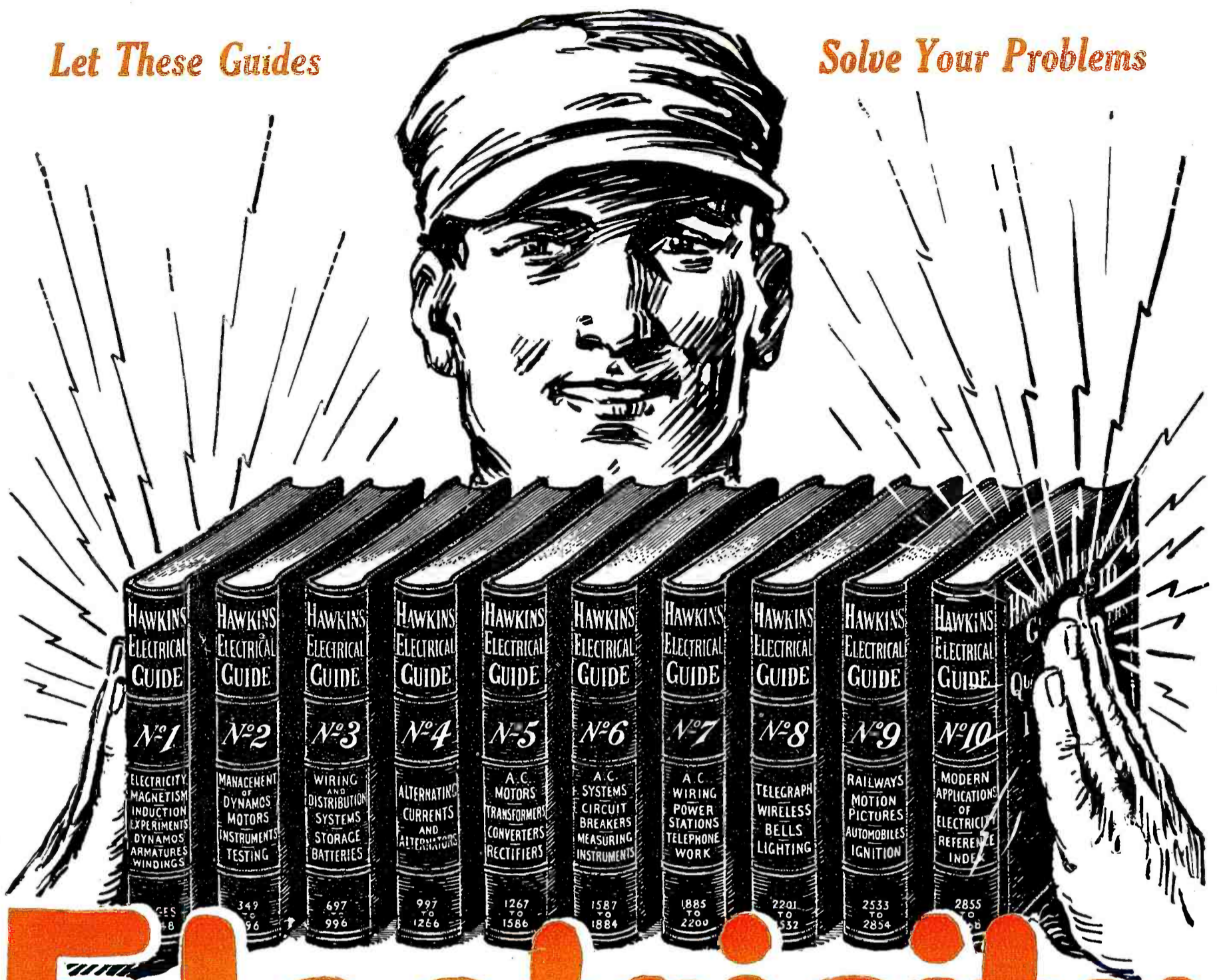

Electricity at your finger ends

HAWKINS ELECTRICAL GUIDES IN TEN VOLUMES

3500 PAGES
4700 PICTURES

\$1 A VOLUME
\$1 A MONTH

SEND NO MONEY—SEND ONLY THIS COUPON

Know the facts in Electricity. They mean more money and better position for you. Hawkins Guides tell you all you need to know about Electricity. Every important electrical subject covered so you can understand it. Easy to study and apply. A complete, practical working course, in 10 volumes. Books are pocket size; flexible covers. Order a set today to look over.

LEARN ALL ABOUT

Magnetism—Induction—Experiments—Dynamometers—Electric Machinery—Motors—Armatures—Armature Windings—Installing of Dynamometers—Electrical Instrument Testing—Practical Management of Dynamometers and Motors—Distribution Systems—Wiring—Wiring Diagrams—Sign Flashers—Storage Batteries—Principles of Alternating Currents and Alternators—Alternating Current Motors—Transformers—Converters—Rectifiers—Alternating Current Systems—Circuit Breakers—Measuring Instruments—Switchboards—Wiring—Power Stations—Installing—Telephone—Telegraph—Wireless—Bells—Lighting—Railways. Also many Modern Practical Applications of Electricity and Ready Reference Index of the ten numbers.

SHIPPED FREE

Not a cent to pay until you see the books. No obligation to buy unless you are satisfied. Send Coupon now—today—and get this great help library and see if it is not worth \$100 to you—you pay \$1.00 a month for ten months or return it.

THEO. AUDEL & CO.,
72 Fifth Ave., New York City

Please submit me for free examination, HAWKINS ELECTRICAL GUIDE (Price \$1 a number). Ship at once prepaid, the 10 numbers. If satisfactory, I agree to send you \$1 within seven days and to further mail you \$1 each month until paid.

Name.....

Occupation

Employed by.....

Home Address.....

Reference

R. N. Aug.

Make Radio a Profession Instead of a Plaything

IT is said that opportunity knocks but once in a man's lifetime. But there are thousands of opportunities knocking at your door right NOW. Get into Radio as a Big Money Making Profession. Here is how:

Become a Certified Radio-trician

A Radio-trician is a person thoroughly proficient in designing, constructing, installing, maintaining, operating, repairing and selling complete Radio transmitting and receiving stations and outfits, by means of which he may pass U. S. Government Examination and secure a First-Class Operator's License for commercial land or sea service or as Broadcasting operator.

A Radio-trician means to Radio what Electrician means to Electricity.

MILLIONS upon millions of dollars are being invested in Radio by far-seeing business men and manufacturers throughout the world. Nearly a million Radio sets are already in use. Yet the industry is still in its infancy.

Thousands of men are needed in Radio. They are needed—to design Radio sets—to invent new Radio improvements; they are needed to manufacture Radio equipment and to install it; they are needed to maintain and operate the great Broadcasting stations and the small Radio sets; they are needed to repair and sell Radio apparatus; they are needed to operate aboard ship and at the transoceanic land stations.

\$5,000,000 per Week for Radio

"Do you realize that America is now spending about \$5,000,000 a week for radio equipment? Do you know that the unfilled orders of one radio manufacturing company alone amount to \$50,000,000? Another conservative manufacturer expects to be turning out \$25,000 worth of receiving sets daily.

"It is safe to estimate that in these times of depression, when people were supposed not to have money to spend, the American public has already invested \$100,000,000 in little boxes and tubes and coils of wire whose sole function is to bring entertainment or information into the home. And this is only the start. An annual radio business of \$400,000,000 is confidently expected.

"With the probable establishment of from 12 to 15 powerful broadcasting stations that will cover the entire country—not to mention a host of other public and independent stations—and with the certainty that improvements in apparatus will keep up sales for years to come, it is undeniable that radio has within a period of six months leaped up as a vast national utility on a par in promise with the automobile, the motion pictures, and with public services like the telephone and electric railways."—From *Popular Science Monthly*.

Hundreds Getting Wealthy

Hundreds of men are already growing wealthy through this new wonder science. The openings for more men are everywhere. What ever interest you may have in Radio can be turned into gold.

If you are a young man of ambition, anxious to get into a profession with a field that is unlimited, get into Radio—become a Certified Radio-trician. If you are a dealer wishing to become thoroughly familiar with Radio so that you can sell Radio apparatus, become a Certified Radio-trician. If you are an amateur, learn Radio thoroughly from every angle so that you may make money out of this business instead of using it only as a plaything or hobby. Now is the time for men of red blood, men of vision, to become Certified Radio-tricians.



Photograph of one of the large Broadcasting stations. Government License required to operate this station. Certified Radio-tricians are qualified to pass Government examinations.

Radio Headquarters

The National Radio Institute is preparing Certified Radio-tricians by mail in spare time at home. Over eight thousand students and graduates have become proficient in this splendid field through the instruction given by this pioneer school during the past seven years. Every phase of Radio is taught from the ground up. Knowledge is imparted through personally corrected lessons, actual practice and actual assembly of Radio Apparatus.

Through our copyrighted books, diagrams, problems, principles and practice on instruments we send you, the National Radio Institute is making Certified Radio-tricians throughout the country

WRITE FOR BOOK

Here is a profession which is paying enormous earnings to men all over the country today—a profession that will make hundreds of men wealthy—a profession far more lucrative than that of any other technical or mechanical employment you can secure.

The world is aflame with radio. What are you going to do to "cash in" on the demand for men, for equipment, for experience? Are you going to set idly by wondering what it is all about, or are you going to make the most of this, the greatest opportunity presented to men of ambition in 50 years?

Write at once for the complete catalog to the National Radio Institute. This is the turning point in your life. Upon your decision *this instant* may depend your entire future. Mail the coupon, or write a letter NOW—for *your own sake*.

NATIONAL RADIO INSTITUTE

Radio Headquarters

Dept. 1178

WASHINGTON, D. C.

NATIONAL RADIO INSTITUTE
Radio Headquarters
Dept. 1178, Washington, D. C.

Please send me your catalog, "How to Learn Radio at Home," describing your Home Study course which will qualify me to become a Certified Radio-trician.

Name

Address

City State.....